

ETC II Network Communicator

Installation and Operation Manual

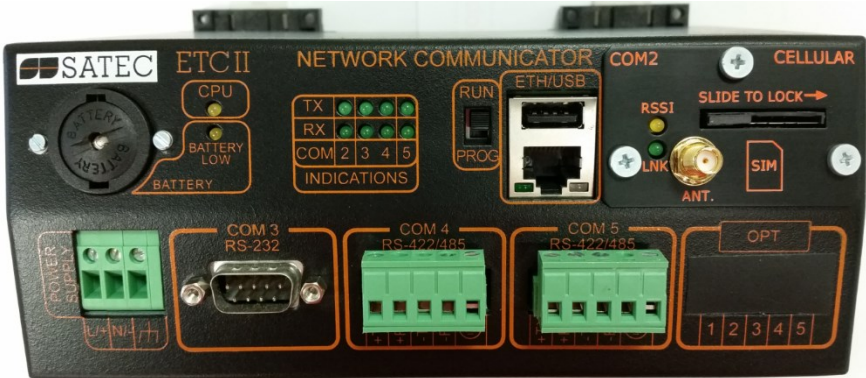

LIMITED WARRANTY

The manufacturer offers the customer a 24-month functional warranty on the instrument for faulty workmanship or parts from date of dispatch from the distributor. In all cases, this warranty is valid for 36 months from the date of production. This warranty is on a return to factory basis.

The manufacturer does not accept liability for any damage caused by instrument malfunction. The manufacturer accepts no responsibility for the suitability of the instrument to the application for which it was purchased.

Failure to install, set up or operate the instrument according to the instructions herein will void the warranty.

Only a duly authorized representative of the manufacturer may open your instrument. The unit should only be opened in a fully anti-static environment. Failure to do so may damage the electronic components and will void the warranty.

The greatest care has been taken to manufacture and calibrate your instrument. However, these instructions do not cover all possible contingencies that may arise during installation, operation or maintenance, and all details and variations of this equipment are not covered by these instructions.

For additional information regarding installation, operation or maintenance of this instrument, contact the manufacturer or your local representative or distributor.

WARNING

Read the instructions in this manual before performing installation, and take note of the following precautions:

- ⇒ Ensure that all incoming AC power and other power sources are turned OFF before performing any work on the instrument. Failure to do so may result in serious or even fatal injury and/or equipment damage.
- ⇒ Before connecting the instrument to the power source, check the labels on the back of the instrument to ensure that your instrument is equipped with the appropriate power supply voltage, input voltages and currents.
- ⇒ Under no circumstances should the instrument be connected to a power source if it is damaged.
- ⇒ To prevent potential fire or shock hazard, do not expose the instrument to rain or moisture.
- ⇒ The secondary of an external current transformer must never be allowed to be open circuit when the primary is energized. An open circuit can cause high voltages, possibly resulting in equipment damage, fire and even serious or fatal injury. Ensure that the current transformer wiring is secured using an external strain relief to reduce mechanical strain on the screw terminals, if necessary.
- ⇒ Only qualified personnel familiar with the instrument and its associated electrical equipment may perform setup procedures.
- ⇒ Do not open the instrument under any circumstances when it is connected to a power source.
- ⇒ Do not use the instrument for primary protection functions where failure of the device can cause fire, injury or death. The instrument can only be used for secondary protection if needed.

Read this manual thoroughly before connecting the device to the current carrying circuits. During operation of the device, hazardous voltages are present on input terminals. Failure to observe precautions can result in serious or even fatal injury or damage to equipment.

All trademarks are property of their respective owners.

Copyright SATEC Ltd. © 2008

Table of Contents

Chapter 1 General Information	5
Chapter 2 Installation	6
Mechanical Installation	6
Electrical Installation	8
Power Source Connection	8
Chassis Ground Connection.....	8
Serial Port Connection	8
Internet Connections.....	11
Chapter 3 Operating the ETC II.....	12
Controls and Indicators	12
PROG-RUN Switch.....	12
LED Indicators	12
Modes of Operation.....	12
Operational Mode.....	12
Program Mode	13
Service Mode	13
Using the ETC II.....	13
Slave Network Connections.....	13
Master Network Connections.....	14
Routing Messages over Slave Networks	15
Shared Device Access.....	16
ETC II Network Applications	16
ETC II Clock	19
Chapter 4 Connecting to the ETC II	20
Using HyperTerminal	20
Running HyperTerminal	20
Opening a Terminal Session.....	21
Closing a Terminal Session	22
Using Telnet	22
Running Telnet from HyperTerminal.....	22
Running the Telnet Client	23
Opening a Telnet Session	23
Closing a Telnet Session	24
Dial-Up Networking	24
Using PAS Software.....	27
Configuration Database	27
Setting up Communications	28
Setting Up the ETC II	30
Authorization	31
Chapter 5 Setting Up the ETC II.....	32
Changing the Password and Security	32
Changing Time and Date	32
Configuring Local Time Settings	33
Configuring Serial Ports	34
Configuring the Network.....	35

Configuring Dial-Up Connections 37
Configuring Gateway Options 39
Configuring Device Routing Table 41
Configuring eXpertPower Client 42
Configuring Data Server 43
Chapter 6 Upgrading Device Firmware 49
Chapter 7 Device Maintenance 51
Appendix Technical Specifications 53

Chapter 1 General Information

The ETC II Network Communicator is a multi-port Internet-to-serial that connects multiple serial RS-485/422 or wireless ZigBee devices to the Internet via a local Ethernet network or via public telephone lines. It can also be used as an Internet-to-Internet router for connecting master stations to remote slave devices that are directly connected to the Internet. The ETC II provides transparent master-slave connections using TCP/IP versions of the popular industrial fieldbus protocols such as Modbus RTU, DNP3, and SATEC ASCII.

The embedded Data server allows the ETC II to automatically acquire data from slave devices and to store it in the memory exchanges or in the data log files in non-volatile memory, so a user application can read blocks of acquired data directly from the ETC II exchanges without waiting for a response from slow serial and wireless devices. The application can also write data to slave devices via the ETC II exchanges instead of waiting until a remote device is accessible. The Data server may be programmed to monitor the slave device's status registers for specific events and to record them to a log file, and send alerts to a remote server.

Features:

- Ethernet 10/100Base-T port communicating to the IP network
- Service USB Device port to communicate with PAS
- Two RS-422/RS-485 master ports for connecting to serial networks
- Service RS-232 port that can be used as a slave port for serial master applications
- Optional CELLULAR modem port communicating to the IP network
- Connections using popular field-bus protocols such as Modbus TCP
- Terminal connection
- Telnet service
- Embedded Data server: up to 250 real-time data exchanges, up to 250 data write exchanges, and up to 250 16-bit status event exchanges
- Up to 250 data log files
- Event log for recording status change events and device diagnostics
- Table top, DIN Rail or wall-mounting options
- 4 Mbyte non-volatile memory with battery backup for storing data and event files
- Real Time Clock
- 120/240V AC/DC operation

Chapter 2 Installation

Mechanical Installation

The ETC II can be located on a table top, or be mounted on a 35-mm DIN rail or on a panel. See Figures 2-2 through 2-4 for mounting instructions. Figure 2-1 shows the device dimensions.

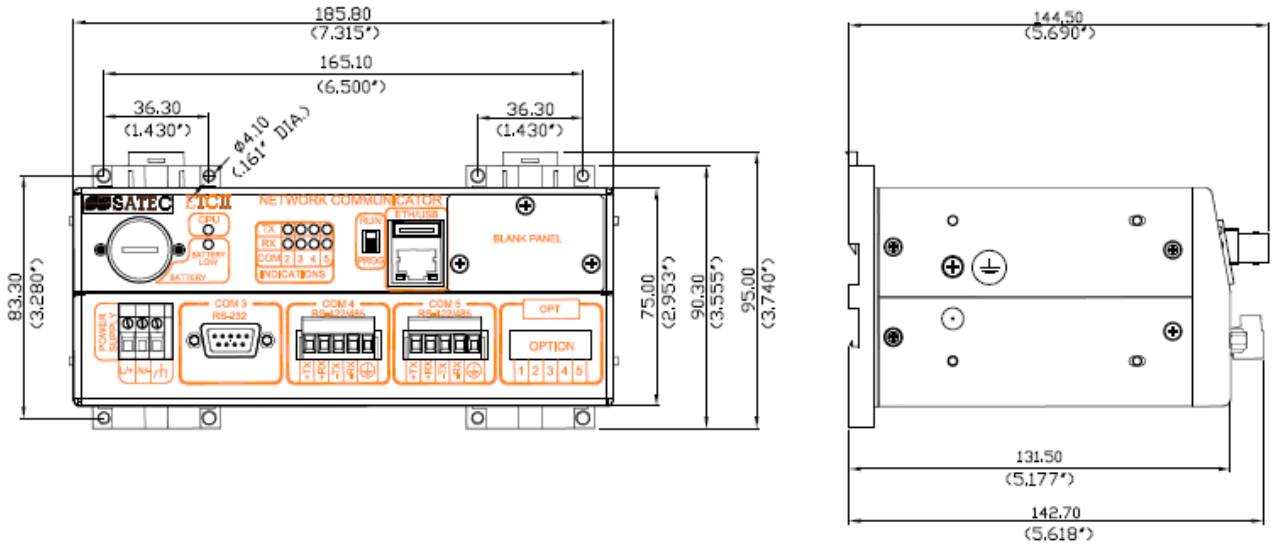
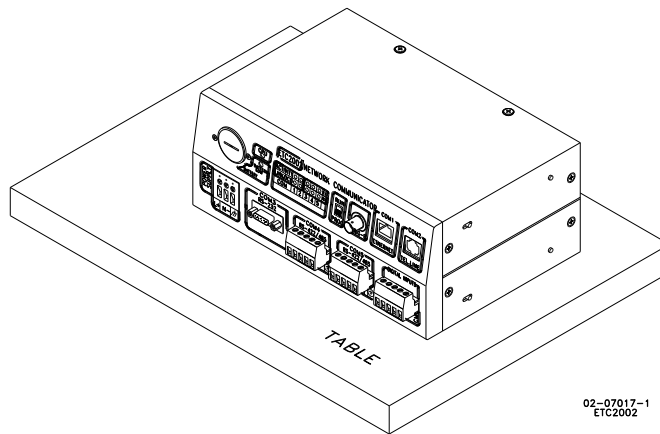

Figure 2-1 ETC II Dimensions



02-07017-1
ETC2002

Figure 2-2 Table Top Placement

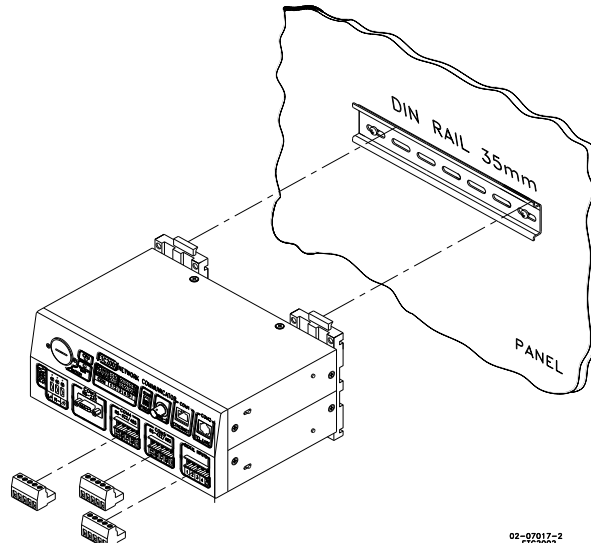

Figure 2-3 Din Rail Mounting

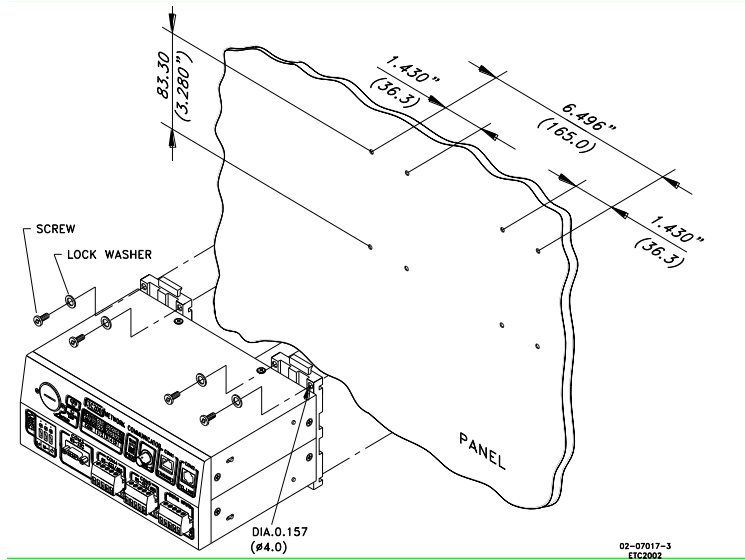

Figure 2-4 Panel Mounting

Electrical Installation

Power Source Connection

Before connecting your device to the power source, check the label on the back of the device to ensure that it is equipped with the appropriate power supply.

AC power supply: Connect the line wire to terminal L/+ and the neutral wire to terminal N/-.

DC power supply: Connect the positive wire to terminal L/+ and the negative wire to terminal N/-.

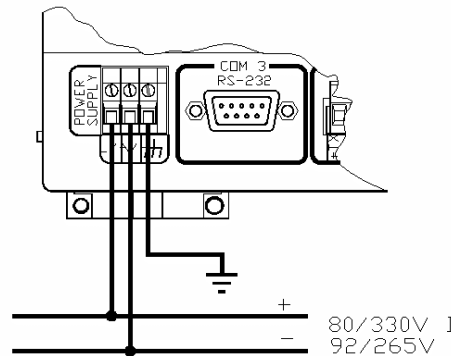

Figure 2-5 Power Source Connection

Chassis Ground Connection

Connect the chassis ground of the device to the switchgear earth ground using a dedicated wire greater than 2 mm²/14 AWG.

Serial Port Connection

The COM3 RS-232 service port is normally used for servicing and setting up the ETC II. It can also be used as a slave port for serial-to-serial communications via the ETC II gateway.

The COM4 and optional COM5 gateway ports are used for connecting the ETC II to the RS-422/RS-485 slave networks with up to 32 devices on each network. For device routing rules, see [Routing Messages over Slave Networks](#) in Chapter 3.

The COM4 port can also be used as a slave port for a connection of a master application to the ETC II via an RS-422/RS-485 serial network.

For proper serial communications, ensure that all port parameters, such as the communication protocol, baud rate, data format and parity, are correctly set in both the ETC II and in the connected serial devices. See [Serial Network Connections](#) in Chapter 3 and [Configuring Serial Ports](#) in Chapter 5 for the ETC II setup instructions. Refer to Figures 2-6 through 2-11 for the connection diagrams.

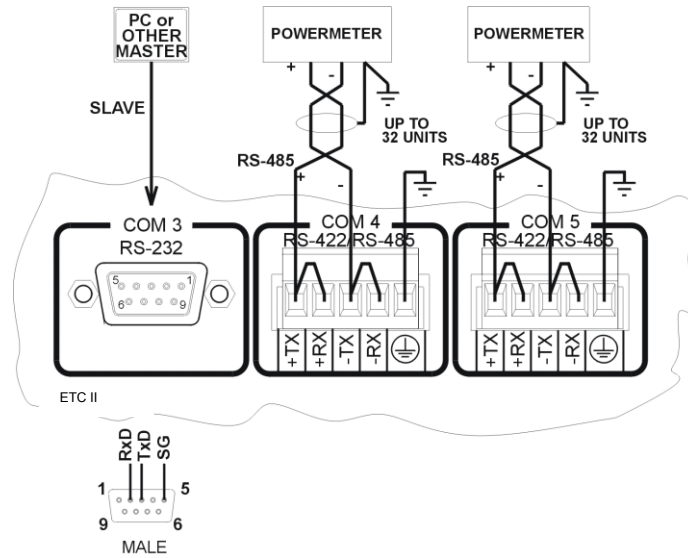

Figure 2-6 Serial Network Connection

COM3 RS-232 Connection

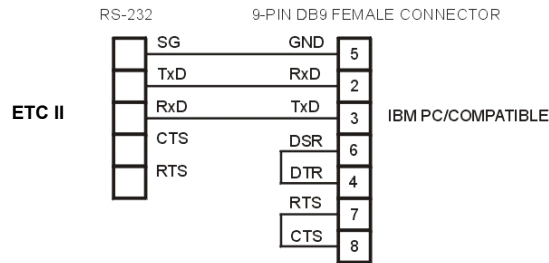

Figure 2-7 Simple RS-232 3-Wire Connection, 9-pin Female Connector

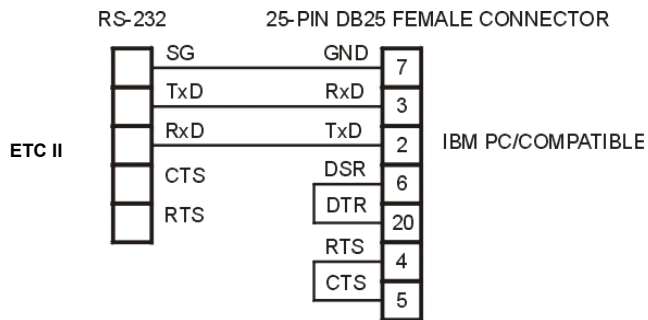

Figure 2-8 Simple RS-232 3-Wire Connection, 25-pin Connector

COM4/COM5 RS-422/RS-485 Connection

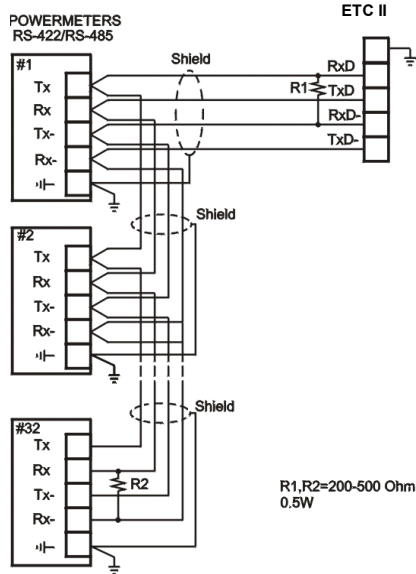

Figure 2-9 Multidrop RS-422 Connection

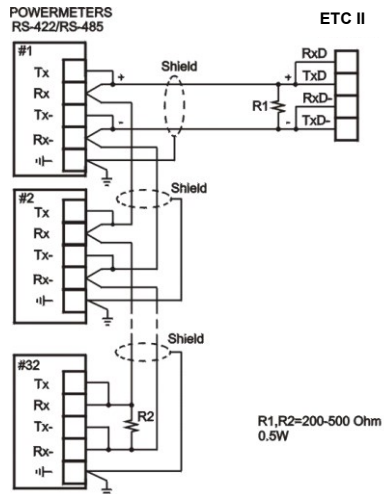

Figure 2-10 Multidrop RS-485 Connection

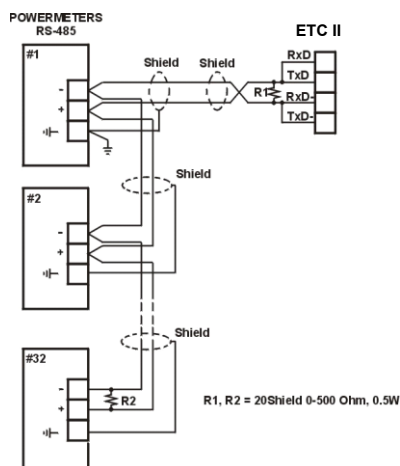

Figure 2-11 Multidrop RS-485 Connection

Internet Connections

The ETC II is connected to the Internet either via a local Ethernet network, or via public telephone lines using a Dial-Up PPP connection.

△ Connecting a device with the factory-set IP address to the Ethernet network can disrupt communications if the IP address exists on the network. Change the IP address in your ETC II as instructed in Section 4 before connecting a device to the network.

Ethernet Connection

Plug the end of the Ethernet cable that came with your device into the wall Ethernet jack or into the Ethernet hub jack, and the other end into the RJ45 jack at the front of the ETC II marked ETHERNET.

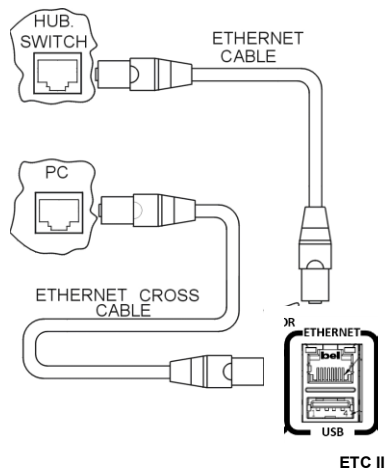

Figure 2-12 Network Connections

See [Internet Connections](#) in Chapter 3 and [configuring the Network](#) in Chapter 5 for instructions on how to program your device for networking via Ethernet.

Chapter 3 Operating the ETC II

Controls and Indicators

PROG-RUN Switch

The ETC II has a PROG-RUN switch that puts the device into program mode for local servicing and programming. The switch must be in the RUN position for normal device operation.

Put the PROG-RUN switch in the PROG position for setting up your device or upgrading device firmware via a Terminal program (see [Using HyperTerminal](#) in Chapter 4 for instructions).

LED Indicators

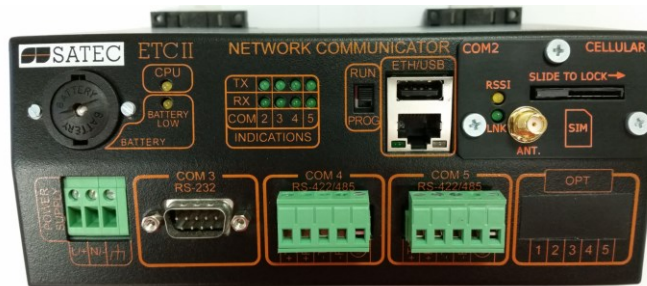

Figure 3-1 Indicator LEDs

The ETC II has two yellow device status LEDs and eight green network status LEDs that show the present device status and activity on communication ports.

The flashing yellow CPU LED indicates the device status as follows:

- The CPU LED flashing for one second with a one-second pause indicates that the device is in the operational state and is functioning normally. Depending on the position of the PROG-RUN switch, the COM3 service port is available for communications via a Terminal program or for master communications.
- The CPU LED flashing briefly 2 times with a one-second pause indicates that the device is in service mode and is not operational.
- The CPU LED flashing briefly 3 times with a one-second pause indicates that a critical error has occurred and the device is not operational. Contact your local distributor for servicing.

The yellow BATTERY LOW LED lights up when the backup battery is near the end of its operational life and should be replaced.

The network status LEDs indicate activity on communication ports as follow:

- COM2 Cellular port optional plug-in module (future): the RX and TX LEDs flash when the device communicate with the Cellular Modem port.
- COM3, COM4 and COM5 serial ports: the RX and TX LEDs flash when the device receives or transmits data via a port.

Modes of Operation

Operational Mode

In the operational mode, the device services the Internet to serial gateway connections from client applications, and the COM3 port operates in slave mode allowing serial-to-serial network connections.

To put the ETC II into operational mode, set the PROG-RUN switch in the RUN position.

Program Mode

In program mode, the COM3 port operates as a service port that allows the user to review or change settings in the device via a Terminal program (see [Using HyperTerminal](#) in Chapter 4 for more information). The device still services the Internet to serial gateway connections, but serial-to-serial master connections through the COM3 port are not available.

To put the device into program mode, set the PROG-RUN switch in the PROG position.

Service Mode

Service mode is used for local device servicing and upgrading firmware through a Terminal program. In service mode, the Internet-to-serial gateway is not operational.

The device enters service mode either from program mode upon an explicit user command sent via a Terminal program, or when the device is powered with the PROG-RUN switch set in the PROG position. See [Upgrading Device Firmware](#) in Chapter 6 for instructions.

Using the ETC II

Slave Network Connections

Serial Network Connections

The ETC II is connected to serial RS-422/485 slave networks via the COM4 and COM5 gateway ports.

The COM4 should be set to master mode to operate as a gateway port. The COM5 port is factory-set to master mode. See [Configuring Serial Ports](#) in Chapter 5 for information on programming serial ports.

The communication protocol to be used for serial networking via the ETC II is defined by the Network TCP service port setting. See [Configuring the Network](#) in Chapter 5 for information on programming the ETC II TCP service port.

Wireless RF Network Connections

The COM5 port can be configured to support a wireless RF ZigBee slave network built on a Helicomm IP-Link platform.

The IP-Link network is an expandable, low-rate wireless ZigBee platform, which allows various configurations, including mesh network topology to be programmed by the user to best match the installation conditions and applications networking needs. A network may contain up to 30 remote nodes with full mesh support and can operate at one of the seven frequencies from 907MHz to 922MHz to avoid interference with other ZigBee networks.

Slave ZigBee devices are provided with the embedded IP-Link 1000 modules. The ETC II is connected to a ZigBee network via an external IP-Link 2000 modem that operates as a master node.

A wireless network is used as a transparent media for delivering Modbus RTU messages. To identify devices on the network, each slave node is assigned a network ID that is identical to the device Modbus address. See [Configuring Wireless RF Connections](#) in Chapter 5 for information on configuring the IP-Link module parameters in the ETC II.

Internet Connections

Starting with V21.5.4, the ETC II provides connections to slave devices that are linked to the Internet via the Modbus/TCP or DNP3/TCP protocol.

The device routing table is used for assigning the IP addresses to slave devices. See [Routing Messages over Slave Networks](#) below for more information on using the device routing table in the ETC II.

To configure Internet connections for your devices:

1. In the device routing table, specify the IP addresses for Internet devices connected to the ETC II. See [Configuring Device Routing Table](#) in Chapter 5 for more information.
2. Enable the routing table in your ETC II via the ETC II Gateway Options Setup (see [Configuring Gateway Options](#) in Chapter 5).

Master Network Connections

Internet Connections

The ETC II provides a TCP server for master client connections on one of the standard TCP ports: 502 (Modbus/TCP), 20000 (DNP3/TCP) or 5002 (SATEC ASCII/TCP). The TCP server supports eight simultaneous client connections.

NOTE:

Starting with V21.5.4, the ETC II provides the permanent Modbus/TCP server on port 502. Selecting the TCP service port in the ETC II (see [Configuring the Network](#) in Chapter 5) launches an additional server either on the DNP3/TCP port 20000, or on the SATEC ASCII/TCP port 5002, allowing simultaneous connections on both ports.

The TCP server can be accessed via a local Ethernet network or via a Dial-up PPP Internet connection using an embedded 56K modem.

The ETC II Dial-up port is programmable either for dial-in connections from a remote TCP client via Windows Dial-Up Networking services, or for dial-out connections to a remote TCP server via a local Internet Service Provider (ISP).

Ethernet Connections

To setup your Ethernet connections:

1. Define the network IP parameters via the ETC II Network Setup. If you use the ETC II eXpertPower client connections via the Ethernet network, define a non-zero default gateway address, so the client connections will be directed to the Ethernet network (see Note in "Dial-Out Connections" below).
2. Define the TCP service port number for your application protocol.

See [Configuring the Network](#) in Chapter 5 for information on programming the TCP service port in your ETC II.

Dial-In Connections

To set up your dial-in connections, define the IP parameters for the modem interface: the IP address, subnet mask and default network gateway, and the number of rings before answering an incoming call.

See [Configuring Dial-Up Connections](#) in Chapter 5 for more information on configuring your modem. See [Dial-Up Networking](#) in Chapter 4 for information on using Windows Dial-Up Networking for dial-in connections.

Dial-Out Connections

Dial-out connections are normally used with eXpertPower™ applications. The ETC II eXpertPower client can initiate connections to the eXpertPower™ server on a time basis. For information on configuring eXpertPower connections, see [Configuring eXpertPower Client](#) in Chapter 5.

To configure your ETC II modem for dial-out connections:

1. Set the default Ethernet gateway address to 0.0.0.0 to direct client connections to the modem network. See [Configuring the Network](#) in Chapter 5 for information on programming the Ethernet port in your ETC II.
2. Define your service provider's phone number, the login name and the password, and select the modem dialing options: the number of redial attempts, the time between attempts, and the connection timeout. Other IP connection parameters are automatically negotiated with the remote server. See [Configuring Dial-Up Connections](#) in Chapter 5 for information on configuring the Dial-Up modem.

NOTE:

If your ETC II has both the Ethernet and modem network interfaces, the eXpertPower client uses one of these for connections to the eXpertPower™ server. The default Ethernet network gateway address defines which one of the networks is used. If the default gateway address is not defined (i.e., it is set to 0.0.0.0), the ETC II uses the dial-out modem connection via your local Internet provider. If you defined the default network gateway address, any call to the IP address, which is not included in the address space of the both networks, is redirected to the default Ethernet gateway.

Serial Master Connections

The ETC II can also be used as a serial-to-serial or a serial-to-wireless gateway. This provides connections to slave networks from serial applications using the COM3 RS-232 or the COM4 RS-422/485 slave port.

To use the COM3 port as a slave port:

1. Configure the COM3 port communication parameters for your master application. See [Configuring Serial Ports](#) in Chapter 5 for information on programming serial ports.
2. Ensure that the PROG-RUN switch is in the RUN position.

To use the COM4 port as a slave port:

1. Configure the COM4 port communication parameters for your master application. See [Configuring Serial Ports](#) in Chapter 5 for information on programming serial ports.
2. Ensure that the COM4 port direction in the port setup is set to "Slave".

Routing Messages over Slave Networks

A device address is used to route master requests to a correct network where the target device is physically located. The device address range is programmable in the range of 1 through 247. It may be restricted by specific protocol limitations.

One of the device addresses is reserved for accessing the ETC II configuration and data registers. The factory-set ETC II network address is 99. It can be moved to another address via the ETC II Gateway Options setup if you wish to use the default ETC II address for addressing your slave devices.

The ETC II has two options for routing messages over the slave networks, depending on whether the device routing table is defined in your ETC II or not.

The first option uses implicit rules that identify the device location statically upon the device address. The following table shows how the messages are routed through the COM4 and COM5 serial ports depending on the port usage. When using non-standard communication protocols, all messages are routed to the COM4 port.

Port	COM5 Unused	COM4 Master + COM5 Serial	COM4 Master + COM5 IP-Link	COM4 Slave + COM5
COM4 Master	1-247	1-32	216-247	-
COM5	-	33-247	1-215	1-247

The second option uses the device routing table. It is available starting with V21.5.4. The routing table explicitly identifies the target network for every individual device connected to the ETC II. For serial and wireless devices, it specifies a serial port to which the device network is connected. For Ethernet devices, it allows you to specify the device's IP address on the Ethernet network.

To use the device routing table:

1. Specify a routing path for every device connected to the ETC II gateway. Specify the IP address for every Internet device and the target serial port for every serial and wireless device connected to the ETC II. See [Configuring Device Routing Table](#) in Chapter 5 for information on programming the device routing table.
2. Enable the routing table in your ETC II via the ETC II Gateway Options Setup (see [Configuring Gateway Options](#) in Chapter 5).

Shared Device Access

Shared device access allows several clients to simultaneously access the slave device's registers either for reading or writing. It is enabled by the default, so different clients can poll registers in the same device without collisions that are normally resolved by the ETC II.

However, accessing a file in the device at the time when another client is reading data from that or another file in the same device could destroy file buffers such that both clients may receive corrupted data.

To avoid possible collisions, the ETC II offers you two options:

1. First, you can entirely disable shared device access so that the ETC II rejects any additional requests addressed to a device that is being accessed by another client. In this event, the ETC II returns an exception response with the error code 10 "Gateway is busy" until the first client closes the session or points to a different device. See [Configuring Gateway Options](#) in Chapter 5 on how to enable or disable shared device accesses in your ETC II.
2. The second option uses the device routing table for defining a device-sharing policy. Shared device access should be enabled in the ETC II (see [Configuring Gateway Options](#) in Chapter 5), and device-sharing rules should be selected for each individual device. In this event, only protected registers, which are defined by a selected access rule, are blocked for shared accesses while others are always available for all clients. See [Configuring Device Routing Table](#) in Chapter 5 for information on programming the device-routing table.

ETC II Network Applications

Transparent Gateway

The ETC II normally provides a means for transparent exchange of messages between master Internet and serial client applications, and slave serial or wireless devices.

The ETC II can manage up to eight concurrent sessions between master stations and slave devices. Each connection is fully transparent for the master. The ETC II forwards client requests to target devices, and then returns responses to the master application, maintaining all timing regulations required by the protocol. The serial networks are accessed in a queued manner that prevents possible collisions.

Data Server

The ETC II has an embedded Data server that allows the user to save time required for polling multiple devices, especially via slow serial interfaces. It utilizes the ETC II non-volatile memory for automatic data acquisition.

The Data server is accessible via the Modbus/TCP protocol from any remote application. The user application can read blocks of ready data directly from

the ETC II memory exchanges without the need to wait until slow devices respond to master requests.

The Data server can also perform a delayed write of data so the application does not need to wait until the device is accessible, but rather can write data to the ETC II memory exchanges, with the ETC II then taking responsibility for delivering data to the target devices.

The Data server can also periodically poll device status registers, record events to a log file and give alerts on specific events.

The following table gives a summary of the available data exchanges.

Exchange Type	Number of Exchanges	Exchange Block Size, registers
Real-time data exchange	250	1-114
Status event exchange	250	1
Data write exchange	250	1-12

NOTE:

The real-time, status event and write data exchanges with the same exchange number are internally linked in the ETC II to the same device address. If you change the device address for one of the exchanges, the same address will be taken for other configured exchanges that have the same exchange number.

See [Configuring Data Server](#) in Chapter 5 for information on configuring data exchanges. Refer to the ETC II Modbus Guide for information on accessing and retrieving data from the Data server exchanges.

Real-Time Data Exchanges

Real-time data exchanges are used for periodic retrieval of data from the connected devices. The ETC II provides up to 250 real-time data exchanges of 1 to 114 registers long. They are directly accessible from remote master applications.

When the Data server is enabled, it acquires data from the connected devices either continuously, or on a periodic basis. If continuous polling is disabled, the devices are requested periodically at predefined poll intervals. If continuous polling is enabled, the ETC II retrieves data from the devices in turn without pauses.

You can individually enable or disable polling data for a specific exchange. If the device has an onboard real-time clock, you can enable periodic RTC updates from the ETC II clock, which may be synchronized with the precise satellite GPS clock using an optional IRIG-B input.

Acquired real-time data is normally stored in the ETC II exchanges. If the user wishes, acquired data can be periodically moved to historical circular files where data is kept for a long time until it is overwritten by newer data.

Data is recorded to historical files at regular intervals. To enable logging, specify a non-zero logging interval in the Data Server Options setup (see [Configuring Data Server](#) in Chapter 5). The logging interval is always represented as a whole number of data polling intervals even if the polling itself is not synchronized with polling intervals, such as in the event of continuous polling. Since the ETC II attempts to synchronize polling devices with the beginning of an hour, it is recommended to program a logging interval in such a manner that it is a whole divisor of 60 minutes.

Historical records can be read in an arbitrary manner, or in a sequential order. See the ETC II Modbus Guide for more information on retrieving log files from your device.

Status Event Exchanges

The Data server logs binary events asserted by the connected devices and gives notification to the eXpertPower server.

A binary event mask specifies critical event bits in the device status register. Whenever the Data server detects a change in the status bits selected by the event mask, it records an event record to the circular Event log file. If the eXpertPower service is enabled in the ETC II, this event initiates a connection to the eXpertPower server.

Polling status events is performed via the status event exchanges. The Data server provides up to 250 event exchanges of 1 register long, with a separate event mask.

The Data server provides the auto re-set option that may be used to clear a latched device status register after it has been read. In most devices, critical events are latched into a status register, so that the new events are not generated until the register is explicitly cleared by a master application.

Since status registers may be implemented in the device either as coils, or as holding registers, you should specify a register type for each event exchange.

Write Data Exchanges

The Data server can provide remote writing data to serviced devices upon user request. Up to 250 write exchanges are supported with a size of 1 to 12 registers.

The following table shows the write exchange layout.

Write Exchange Block

Description	Range
Exchange number	0-249
Write flag	0 – Data has been written 1 – Data is waiting to be written
Data register 1	
...	
Data register 12	

To send data to a device via a write exchange, write data to the write exchange with the write flag being set to 1. The write flag is automatically cleared after the data has been successfully transferred to the device. Always check this flag before writing new data to the exchange to ensure it is empty, otherwise previously written data may be lost.

Monitoring Digital Inputs

The Data server provides continuous monitoring events asserted by the ET2002 digital inputs and gives notification to the eXpertPower server.

Whenever the Data server detects a change in the status of the ETC II digital inputs, it records an event record to the Event log file. If the eXpertPower service is enabled in the ETC II, this event initiates a connection to the eXpertPower server.

eXpertPower™ Client

The ETC II has an embedded eXpertPower™ client that provides communications with the eXpertPower™ server - the SATEC proprietary Internet services.

Connections to the eXpertPower™ server are normally handled on a periodic basis, but can also be initiated via the ETC II event exchanges and the ETC II digital inputs DI1-DI4 to give an alert for specific events.

See [Configuring eXpertPower Client](#) in Chapter 5 for more information on configuring the eXpertPower client in your ETC II.

ETC II Clock

GPS Clock Synchronization

The ETC II has the IRIG-B input port for receiving the IRIG-B time code signal from an external GPS satellite clock. The ETC II IRIG-B port uses unmodulated pulse-width coded time code signal (unbalanced 5V level).

To use the IRIG-B input:

1. Connect the GPS master clock to the IRIG-B BNC connector on the front of the ETC II
2. Define your time zone offset in the Local Settings setup. See [Configuring Local Time Settings](#) in Chapter 5 for information on configuring time options in your device.

When the IRIG-B signal is present on the device input, the ETC II automatically synchronizes its clock with the GPS time each second, normally with accuracy better than 1 millisecond if the time is synchronized with the GPS satellite time. If the GPS clock loses the satellite signal, the clock continues to generate the IRIG-B time code referenced to the last available satellite time, but the time quality may deteriorate. Such signal losses can last from a few minutes to several hours. During such outages, the time code generated by the GPS receiver is typically accurate to within a few milliseconds over a 24-hour period.

If the IRIG-B signal is not present on the device input, the ETC II automatically uses its internal RTC clock.

Daylight Savings Time

The ETC II clock can automatically switch the clock from standard time to daylight savings time (DTS) at preset time switch dates. The default factory-set time change points are set for the U.S.A.

When the daylight savings time is enabled, the ETC II automatically adjusts the device clock at 02.00 AM when daylight savings time begins/ends.

If the daylight savings time option is disabled, you must manually adjust the device clock for daylight savings time. The daylight savings time option is disabled in the ETC II by default.

See [Configuring Local Time Settings](#) in Chapter 5 for information on configuring local time options in your device.

Chapter 4 Connecting to the ETC II

Using HyperTerminal

Windows HyperTerminal allows you to configure the network, communications and security settings in your ETC II, and to view certain diagnostic information such as device diagnostics and network statistics. HyperTerminal is also used for servicing the ETC II and upgrading the device firmware.

Running HyperTerminal

1. Connect your PC to the ETC II COM3 RS-232 port using the standard RS-232 DTE-DTE (null-modem) cable that came with your ETC II.
2. Run HyperTerminal from the Windows Start -> Programs -> Accessories -> Communications menu.

Type a name for your new connection and click OK.

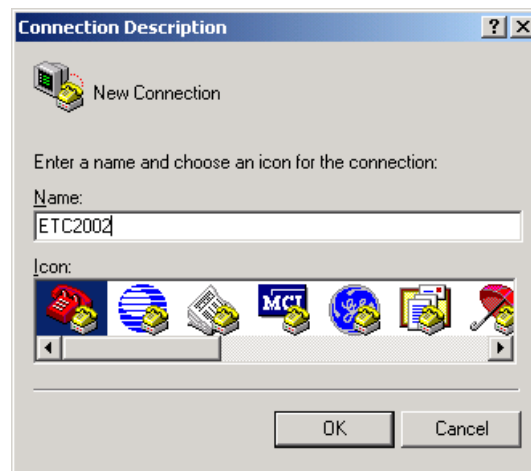

In the “Connect Using” box, select the PC COM port to which your ETC II is connected and click OK.



3. Select 19200 bps in the “Bits per second” box, select “Xon/Xoff” in the “Flow control box”, and then click OK.

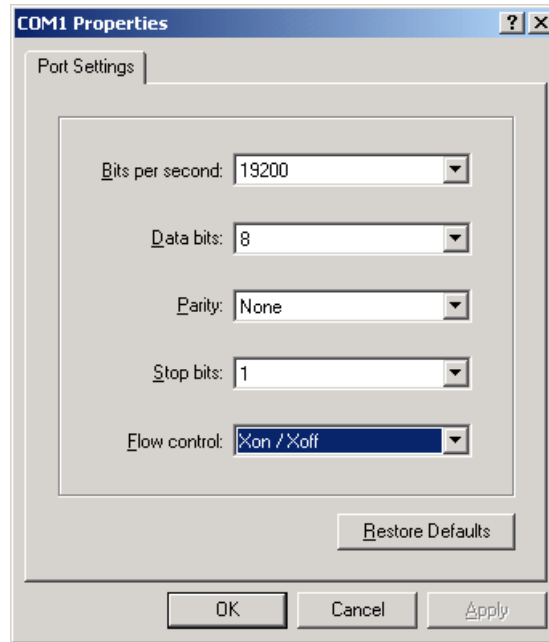

4. From the File menu, select Save to save your settings for the ETC II session. When you next open a session and the New Connection dialog appears, click Cancel, select Open from the File menu, and then double-click on your session file.

Opening a Terminal Session

Put the PROG-RUN key on the ETC II in the PROG position. The ETC II Terminal program is now launched and will print a list of the available commands as follows:

```
ETC II Ethernet Converter Ver. 21.X.X
SATEC/TCP Server, Modbus/TCP Server, DNP3.0/TCP
Server.
Copyright (C) 2002, SATEC Ltd.
```

ETC Terminal commands

```
-----
h                Displays this text
ver             About ETC version
password       Password setting
ip            TCP/IP settings
port         TCP service port number
b           Change the terminal baud
rate
COM[Port] [Baud] [Data] Serial port settings:
                        Port = 3/4/5
                        Baud = 1200/.../57600
                        Data = 7E/8N/8E
modem        Modem connection parameters
XP          eXpertPower client
parameters
time [hh:mm:ss]    Time
date [dd/mm/yy]   Date
log           Prints network log
stat         Prints network statistics
stat ip      Prints current network
IP addresses
stat xp      Prints XP client status
service     Service Menu
datasrv     Data server configuration
```

<code>run dump</code>	Starts dumping the log to
<code>console</code>	
<code>run net</code>	Starts the network
<code>run server</code>	Starts the TCP server
<code>stop dump</code>	Stops dumping the log to
<code>console</code>	
<code>stop net</code>	Shuts the network down
<code>stop server</code>	Shuts the TCP server down
<code>reset</code>	Resets the device
<code>quit</code>	Quit console

You are prompted for the password to login, as in the following example:

```
Login password: *
```

```
>
```

If your login was successful, you are not prompted for the password again until you close the terminal session. The default ETC II password is 0 unless you have changed it. A password is always required for a terminal session regardless of whether the communications security is enabled or disabled.

After receiving the Terminal prompt ">", you may enter your commands.

Closing a Terminal Session

To close your terminal session, put the PROGRAM-RUN key on the ETC II in the RUN position.

Using Telnet

Unlike HyperTerminal, Telnet allows you to access the device through a local network or from any location on the Internet where your device is visible. Just like Windows HyperTerminal, Windows Telnet allows you to configure the network, communications and security settings in your ETC II, and to view certain diagnostic information such as device diagnostics and network statistics.

You can establish a telnet connection to the device from Windows HyperTerminal or from Windows Telnet Client.

Running Telnet from HyperTerminal

1. Run HyperTerminal from the Windows Start -> Programs -> Accessories -> Communications menu.
2. Type a name for your new connection and click OK.

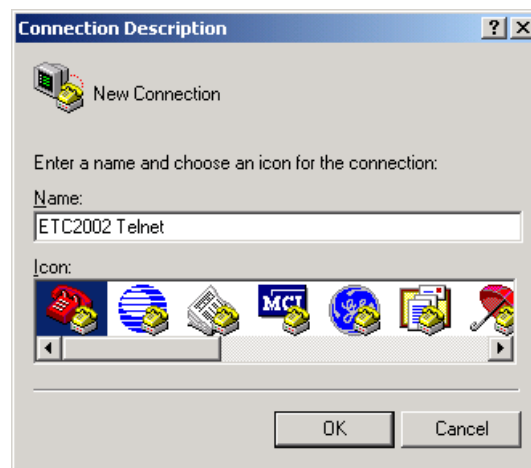

3. Select TCP/IP (Winsock) in the “Connect Using” box, type the ETC II IP address in the “Host address” box, and set the port number to 5023. Click OK.

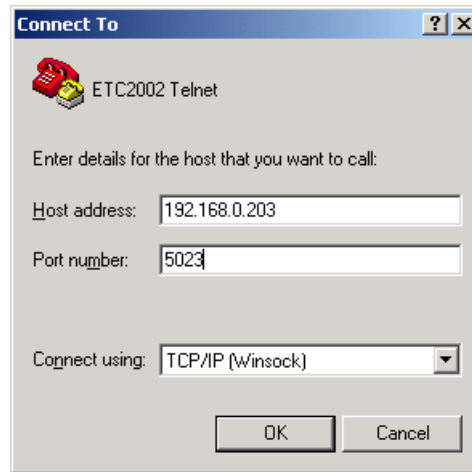

Running the Telnet Client

1. From the Start menu, select Run, type `telnet` and click OK.

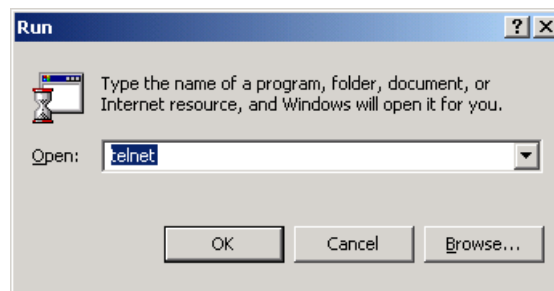

The following text appears in a window:

```
Microsoft (R) Windows 2000 (TM) Version 5.00
(Build 2195)
Welcome to Microsoft Telnet Client
Telnet Client Build 5.00.99206.1
Escape Character is 'CTRL+]'

Microsoft Telnet>
```

2. Type `open` followed by the ETC II IP address, followed by 5023 as the ETC II port number, for example:

```
Microsoft Telnet>open 192.168.0.203 5023
```

Opening a Telnet Session

When a telnet connection is established, the ETC II Telnet server prints a list of the available commands as follows:

```
ETC Telnet Commands.
```

```
-----
h                - Displays this text
ver              - About ETC version
password         - Password setting
ip               - TCP/IP settings
port             - TCP service port number
```

```

COM[Port] [Baud] [Data] - Serial port
settings:
                                Port = 3/4/5
                                Baud      =
1200/2400/.../57600/115200
                                Data = 7E/8N/8E
mbus - Set MODBUS ID range and ETC
MODBUS ID
modem - Modem connection parameters
XP - eXpertPower client parameters
time [hh:mm:ss] - Time
date [dd/mm/yy] - Date
log - Prints network log
stat - Prints network statistics
stat ip - Prints current network IP
addresses
stat xp - Prints XP client status
service - Service Menu
datasrv - Data server configuration
run dump - Starts dumping the log to
console
run server - Starts the TCP server
stop dump - Stops dumping the log to
console
stop server - Shuts the TCP server down
reset - Resets the device
rsttmr - Reset timer period
quit - Quit console

```

You are prompted for the login name and password to login, as in the following example:

```

Login Name: *****
Login password: *****
>

```

If your login was successful, you are not prompted for the password again until you close your telnet session. Consult your local representative for the default ETC II login name and password.

After receiving the Telnet prompt ">", you may enter your commands.

Closing a Telnet Session

To close your Telnet session, close your telnet client application.

Dial-Up Networking

You can use Windows Dial-Up networking to access the ETC II via public telephone lines, either for connecting to the ETC II TCP server from PAS or your remote Internet application, or for connecting to the ETC II Telnet server from the Windows Telnet client.

To use Windows Dial-Up Networking for dial-in connections, create a new Dial-Up connection for your ETC II:

1. From the Start menu, select Settings -> Network and Dial-Up Connections -> Make New Connection.
2. Select "Dial-up to the Internet" and click Next.

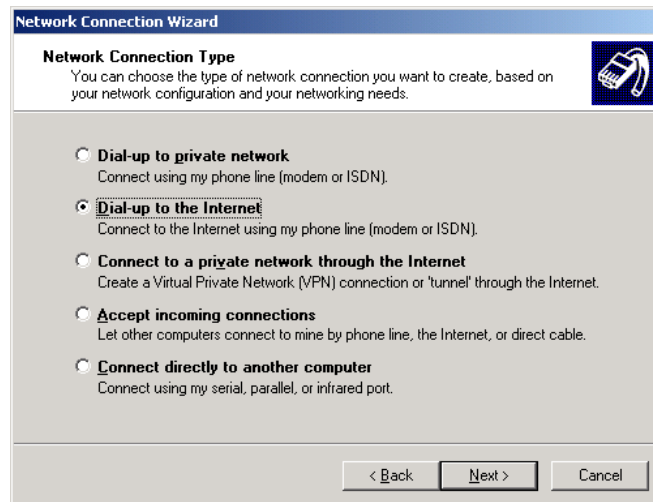

3. Select “I want to set my Internet connection manually” and click Next.

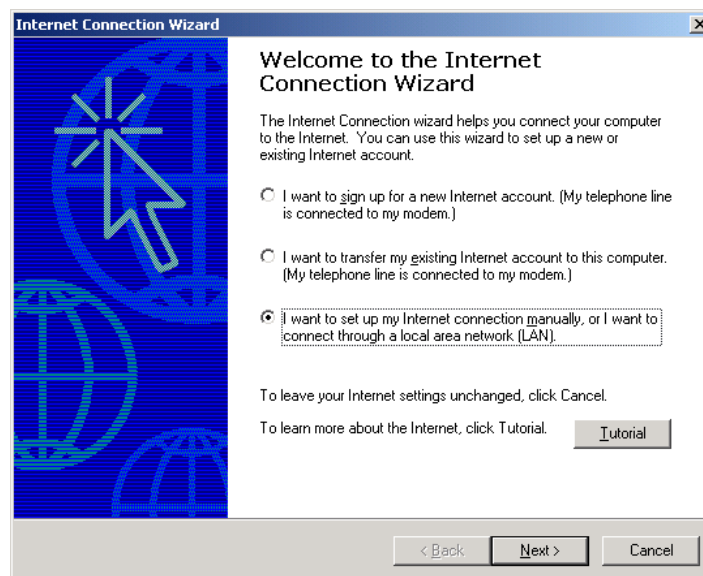

4. Select “I connect through a phone line and a modem” and click Next.

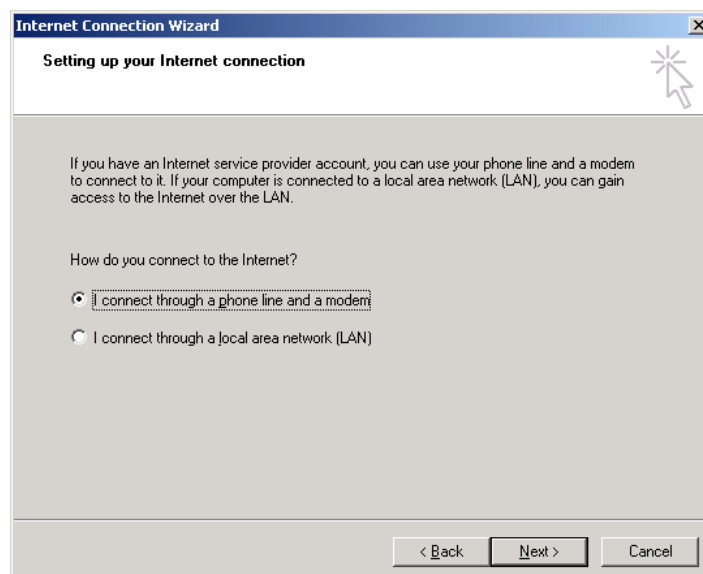

5. Select a modem you use to connect to the Internet and click Next.

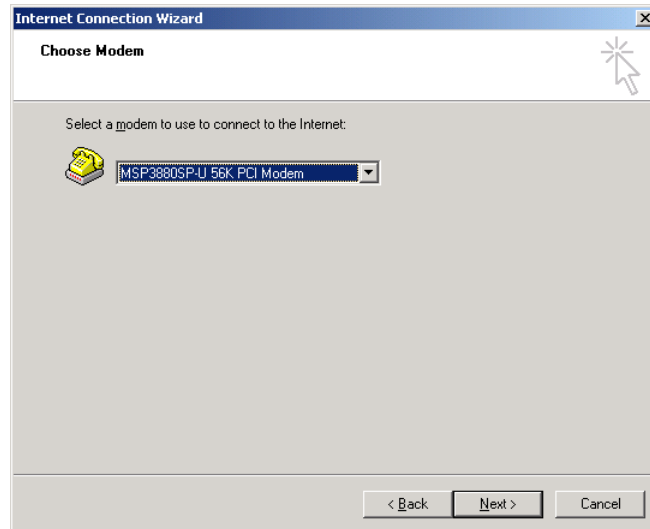

6. Type the telephone number of the ETC II modem and click Next.

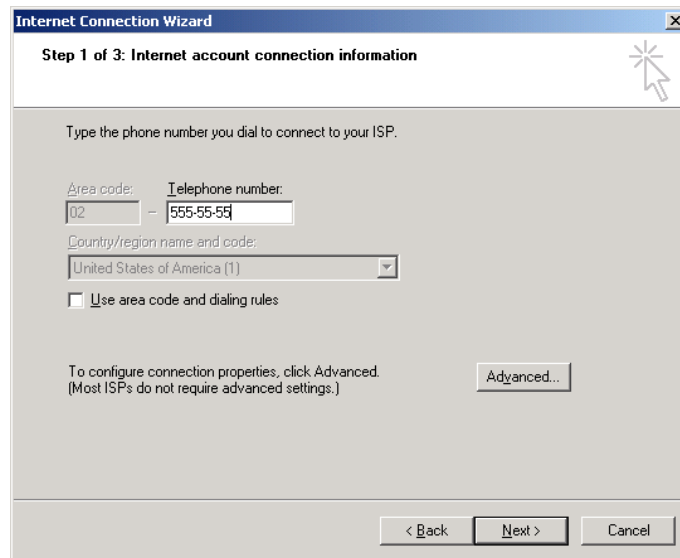

7. Leave the user name and password boxes blank and click "Next". In dial-in mode, the ETC II does not require the name and password to login.

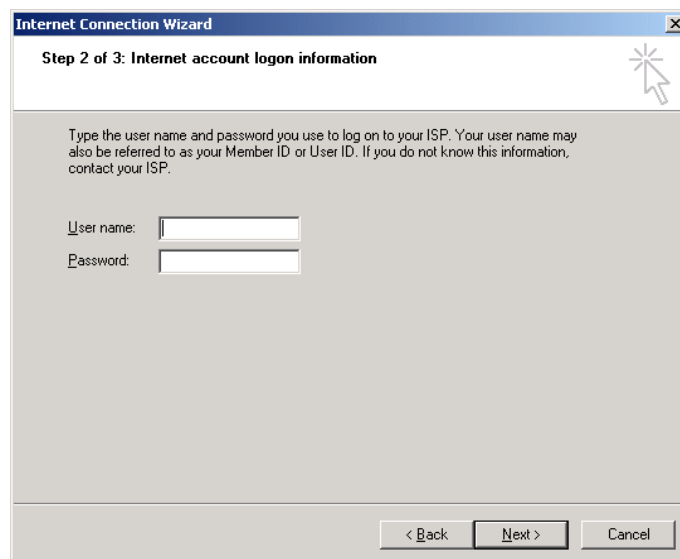

8. Type the connection name and click “Next”.

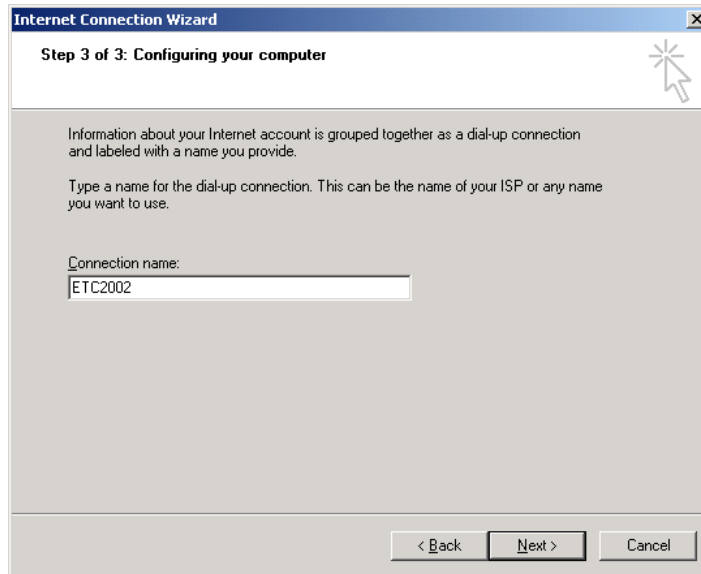

9. Check “No” and click “Next”.



Later, you can use the name of your Dial-up connection in Internet applications to dial to the ETC II. For all Dial-up Internet connections, use the IP address you have defined in your ETC II for the modem interface via the Dial-Up Networking Setup (see [Configuring Dial-Up Connections](#) in Chapter 5).

Using PAS Software

Supplemental PAS software that came with your ETC II can be used for configuring the ETC II via the Internet.

See the “PAS Getting Started Guide” supplied on the installation CD for information on how to install PAS on your PC.

Configuration Database

To communicate with the ETC II from PAS, create a site database for your device. All communication and configuration data for your device will be stored in this database. During configuration, store all setups to the site

database so that PAS recognizes device properties regardless of whether the ETC II is online or offline.

To create a new database for your ETC II:

1. Select Configuration from the Tools menu, and then click the Sites button on the right-hand side.

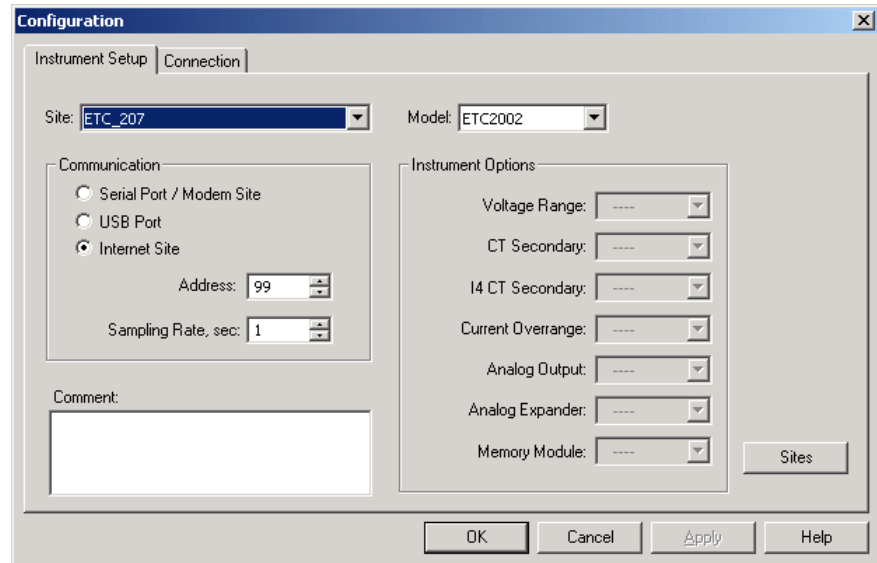

2. From the “Look in” box, select the directory where the new database will be stored. By default, it is the “Sites” directory. Type a site name for your device in the “File name” box, click New, and then click OK.
3. On the Instrument Setup tab, select “ETC II” in the “Model” box.
4. Set the device address to 99 unless you have changed the ETC II default address in your device.
5. If you wish to add any comments for your device, type them into the “Comment” box.

Setting up Communications

Communicating through the Ethernet

To communicate through the Ethernet port:

1. On the Instrument Setup tab, select Internet Site.
2. Click on the Connection tab.
3. Click on the “IP address” and type in the IP address that you defined in Network Setup in your ETC II. The factory set default IP address is 192.168.0.203.
4. In the “Protocol” box, select the communications protocol for the ETC II TCP port. The host port is set automatically as you select the protocol. Select “Modbus RTU” for Modbus/TCP, “DNP3” for DNP3/TCP, or “SATEC ASCII” for SATEC ASCII/TCP.
5. In the “Wait for answer” box, adjust the time that PAS should wait for a connection before announcing an error and the number of re-tries that PAS should use to receive a response from the device if communications fail.

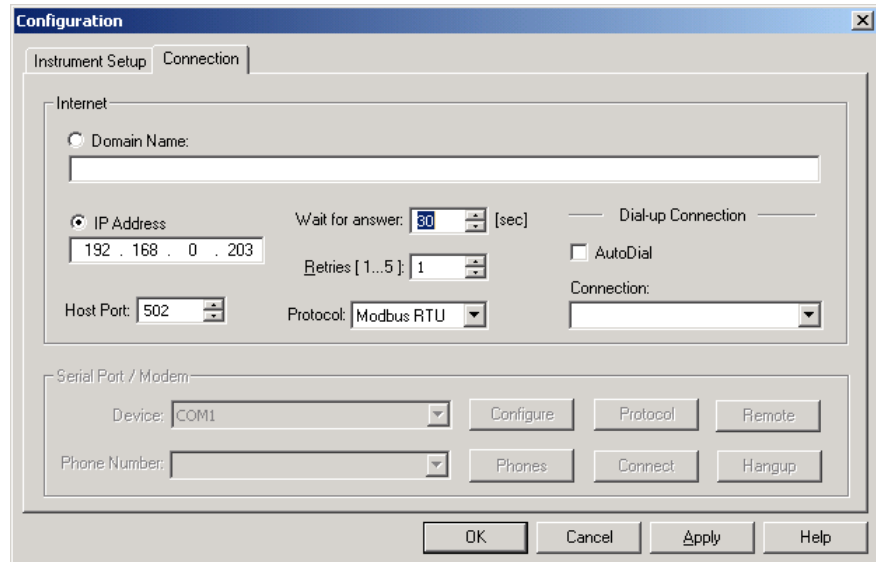

Communicating through a Dial-up Connection

Configuring a Dial-up Connection

To communicate through a Dial-up modem:

1. On the Instrument Setup tab, select Internet Site.
2. Click on the Connection tab.

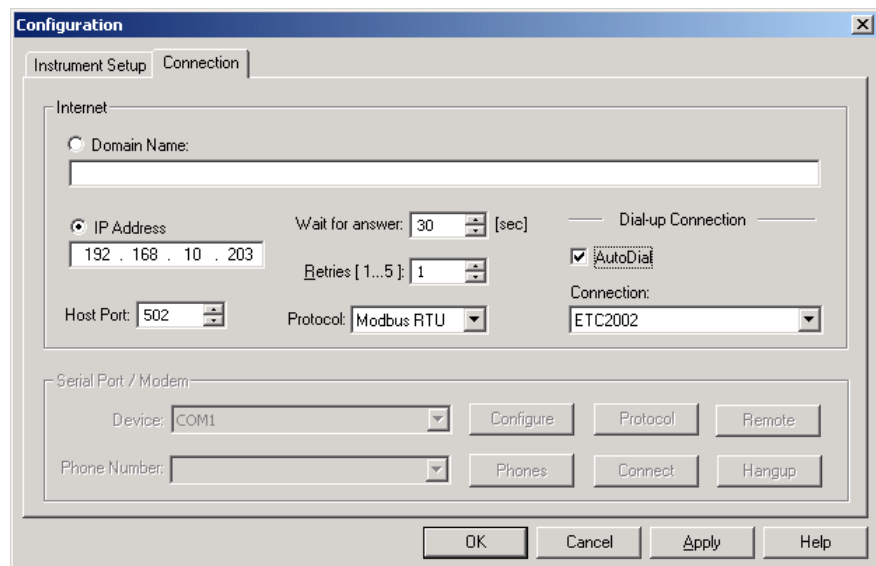

3. Click on the "IP address" and type in the IP address you defined in Dial-Up Networking Setup in your ETC II. The default IP address preset at the factory is 192.168.10.203.
4. In the "Protocol" box, select the communications protocol for the ETC II TCP port. The host port is set automatically as you select the protocol. Select "Modbus RTU" for Modbus/TCP, "DNP3" for DNP3/TCP, or "SATEC ASCII" for SATEC ASCII/TCP.
5. In the "Wait for answer" box, adjust the time that PAS should wait for a connection before announcing an error and the number of re-tries that PAS should use to receive a response from the device if communications fail.
6. In the "Connection" box, select the Dial-up connection you created for the ETC II. See [Dial-Up Networking](#) for information on how to create a Dial-up connection in Windows.

7. Check the AutoDial box, if you wish PAS to automatically connect to your ETC II every time you access it from PAS; otherwise you must manually dial your connection.

Manually Dialing your Connection

To manually dial your connection:

1. Select your connection name from the Start menu -> Settings -> Network and Dial-Up Connections.

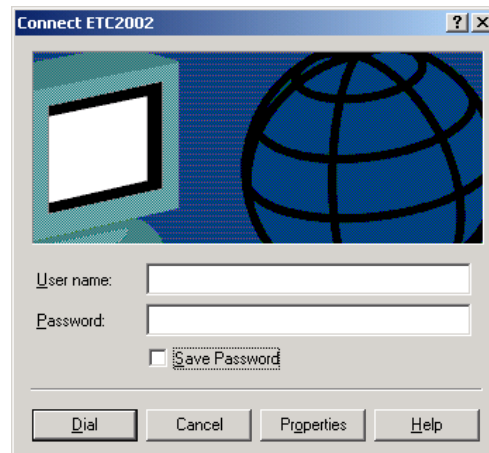

2. Click Dial.

Setting Up the ETC II

PAS allows you to prepare setup data for the ETC II offline without the need to have it connected to your PC.

Select the ETC II site from the list box on the PAS toolbar, and then select the desired setup group from the Meter Setup menu. Click on the tab with the setup you want to create or modify, and then fill in the boxes with the desired configuration data. Click the "Save as..." button to store your new data to the site database.

To save your setup to another site database, select it from the file panel, and then click OK.

To re-use setups from another site, copy them to your present site database. Click Open, select the desired site database, and then click OK. The opened setup is copied to your site database.

You can also copy all setups from one site database into another site's database. Select a device site from the list box on the toolbar from which you want to reproduce setups, and then select "Copy to..." from the Meter Setup menu. Select the site database to which to copy setups, and click OK.

Downloading Setup to the ETC II

You can update each setup in your ETC II one at a time or download all setups together from the site database.

To update a particular setup in your device, check the On-line button on the PAS toolbar, select a device site from the list box on the toolbar, and then select the desired setup group from the Meter Setup menu. Click on the tab of the setup you want to download to the device, and then click Send.

To download all setups to your device at once, check the On-line button on the PAS toolbar, select the device site from the list box on the toolbar, and then select Download Setups from the Meter Setup menu.

Uploading Setup from the ETC II

To upload the setup from the ETC II to the site database, check the On-line button on the PAS toolbar, select the device site from the list box on the toolbar, and then select Upload Setups from the Meter Setup menu.

Authorization

If communications with your ETC II is secured, you are prompted for the password when you send new setup data to the device.

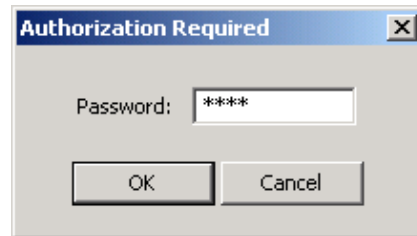

Enter the password and click OK. If your authorization was successful, you are not prompted for the password again until you close the dialog window.

Chapter 5 Setting Up the ETC II

You can configure your ETC II via the Terminal program connected to the device through the COM3 service port, via the Telnet, or via PAS. See [Connecting to the ETC II](#) for information on establishing a connection with your device using different communication options.

Changing the Password and Security

Using HyperTerminal or Telnet

To change your password or a security option:

Type `password` and press Enter. The following prompt appears:

```
> password
```

```
New Password [0-99999999] :
```

To change the password, type your new password (up to 8 digits) and press Enter, then repeat your new password when prompted and press Enter. To leave the password unchanged, just press Enter.

```
New Password [0-99999999] : *****
Repeat Password [0-99999999] : *****
```

Type `y` to enable or `n` to disable password checking, and then press Enter. To leave the current setting unchanged, just press Enter.

```
Comm/Network Protection Enabled [y/n] : N
New: Y
```

Using PAS

To change the password, check the On-line button on the PAS toolbar, select Administration from the Monitor menu, and then select Change Password.

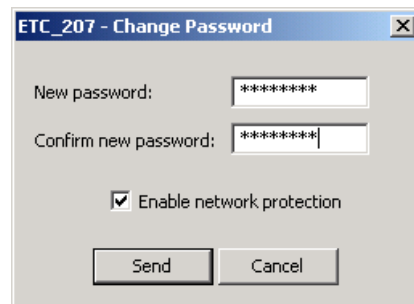

To change the password:

1. Type in a new 8-digit password.
2. Repeat the password in the Confirm box.
3. Check the “Enable network protection” box to enable password checking.
4. Click Send.

Changing Time and Date

Using HyperTerminal or Telnet

To view or change time or date in the ETC II, type `time` or `date`, and then press Enter. To change the time or date, type the new setting after the prompt and press Enter. To leave the time unchanged, just press Enter.

```
>time
```

```
Time: 15:24:49
```

```
New:
```

```
or
```

```
>date
```

```
Date (dd/mm/yy): 27/04/03
```

```
New:
```

Using PAS

Select the ETC II site from the list box on the PAS toolbar, check the On-line button, and then select RTC from the Monitor menu.

Click Set to synchronize the ETC II clock with your PC's clock.

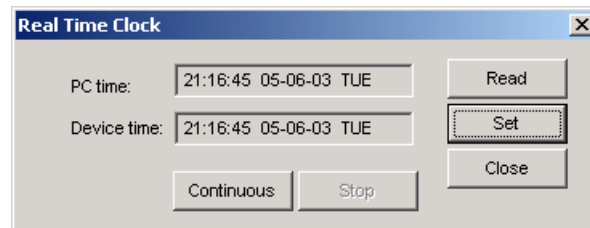

Configuring Local Time Settings

Using PAS

This setup allows you to specify your time zone and daylight savings time options in the ETC II.

Select the ETC II site from the list box on the PAS toolbar, select General Setup from the Meter Setup menu, and then click on the Local Settings tab.

The available setup options are listed in the following table:

Parameter	Options	Default	Description
Time zone offset, min	-720 to 720 min	-300 (Eastern Time)	Local offset in minutes from UTC (Universal Coordinated or Greenwich Mean Time). It is used to produce a local time from the GPS IRIG-B time code.
Daylight savings time	Disabled Enabled	Disabled	When DST is disabled, the RTC operates in standard time only. When enabled, the device automatically updates the time at 2:00 AM at the pre-defined DST switch dates.
DST start month DST start week DST start weekday	Month-week-weekday Week = 1 st , 2 nd , 3 rd , 4 th or Last (last week of the month)	First Sunday in April	The date when Daylight Savings Time begins. The DST switch point is specified by the month, week of the month and weekday. By default, DST starts at 2:00 AM on the first Sunday in April of each year.
DST end month DST end week DST end weekday	Month-week-weekday Week = 1 st , 2 nd , 3 rd , 4 th or Last (last week of the month)	Last Sunday in October	The date when Daylight Savings Time ends. The DST switch point is specified by the month, week of the month and weekday. By default, DST ends at 2:00 AM on the last Sunday in October of each year.

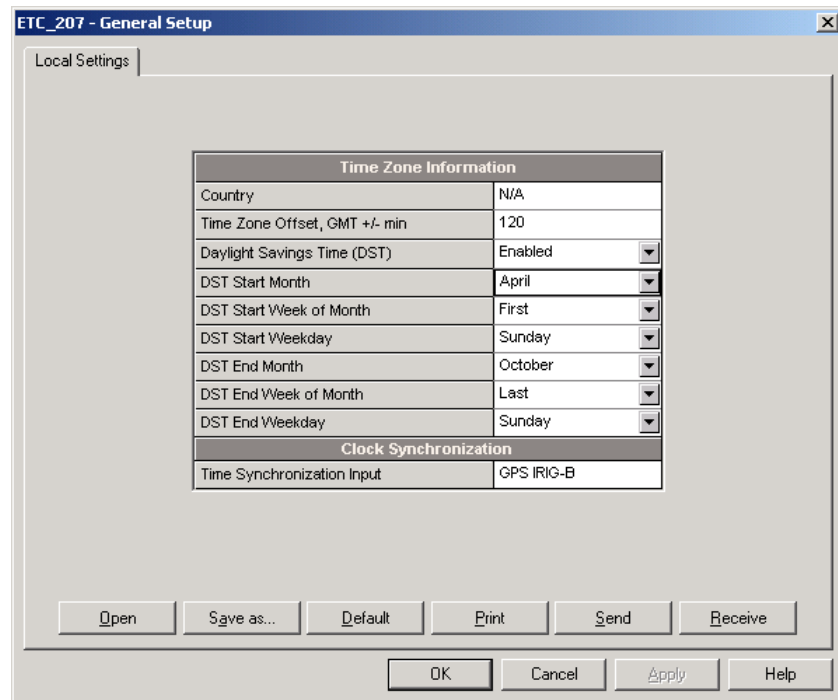

The daylight savings time option is disabled in the ETC II by default. The default daylight savings time change points are pre-set for the U.S.A.

When daylight savings time is enabled, the meter automatically adjusts the device clock at 02.00 AM when daylight savings time begins/ends. If the daylight savings time option is disabled, you must manually adjust the device clock for daylight savings time.

Configuring Serial Ports

Using HyperTerminal or Telnet

To view the present serial port settings, type `com` and press Enter.

```
>com
COM3 19200 8N
COM4 9600 8N
COM5 9600 8N
```

To change the serial port settings, type `com` followed by the port number, baud rate and data format, separated by a space, and press Enter, as in the following example:

```
>com3 19200 8N
COM3 19200 8N
COM4 9600 8N
COM5 9600 8N
```

Using PAS

To enter the setup dialog, select the ETC II site from the list box on the PAS toolbar, select Communications Setup from the Meter Setup menu, and then click on the Serial Ports Setup tab. Select the desired device port in the "Port" box.

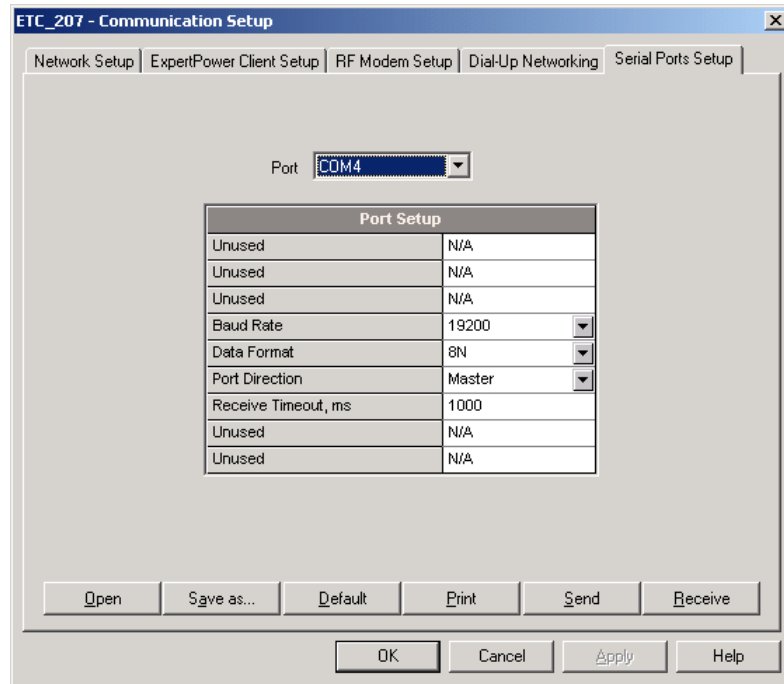

To change the port settings, select desired port parameters, and then click Send. See [Serial Port Connection](#) in Chapter 3 for information on using serial ports and available options.

Configuring the Network

Using HyperTerminal or Telnet

To view your present network settings, type **stat ip** and press Enter:

```
>stat ip
Ethernet Address Statistics (ENET)
  Name:                D-Link DE-220 Ethernet
driver
  IP address:          192.168.0.213
  Subnet mask:         255.255.255.0
  Gateway:             192.168.0.1
PPP Address Statistics (PNET)
  Name:                Modem Driver
  IP address:          192.168.10.203
  Subnet mask:         255.255.255.0
  Gateway:             192.168.10.204
```

To change the network settings, type **ip** and press Enter. If you wish to change a parameter, type your new setting after the prompt and press Enter. To leave the setting unchanged, just press Enter.

```
>ip
Use DHCP (0/1 = no/yes): 0
New:
Network IP address: 192.168.0.203
New:
Network subnet mask: 255.255.255.0
New:
Network default gateway: 192.168.0.1
```

New :

Refer to your network administrator for the available IP address and correct subnet mask and default gateway settings.

If you enable DHCP (Dynamic Host Configuration Protocol), the ETC II obtains the network settings automatically from your network server when the ETC II restarts. You must know the actual IP address assigned to your ETC II in order to specify the device network address in PAS or another application software. Use the **stat ip** command to view the actual IP address assigned to your device.

NOTES:

1. If you use the modem interface for dial-out Internet connections, set the default gateway address to 0.0.0.0. See [Dial-Out Connections](#) in Chapter 3 for more information on using dial-out networking.
2. When you change a network parameter, the ETC II restarts the network to accept your new settings. If you configure your device through telnet, your current connection will be lost and you will be required to open a new session.

To view or change the ETC II TCP server port setting, type **port** and press Enter.

```
>port
```

```
TCP service port: 502
```

New :

The TCP service port number defines the communication protocol for the ETC II gateway that is used for master-slave communications over the networks. See the table below for available port numbers.

Using PAS

To enter the Setup dialog, select the ETC II site from the list box on the PAS toolbar, select Communications Setup from the Meter Setup menu, and then click on the Network Setup tab.

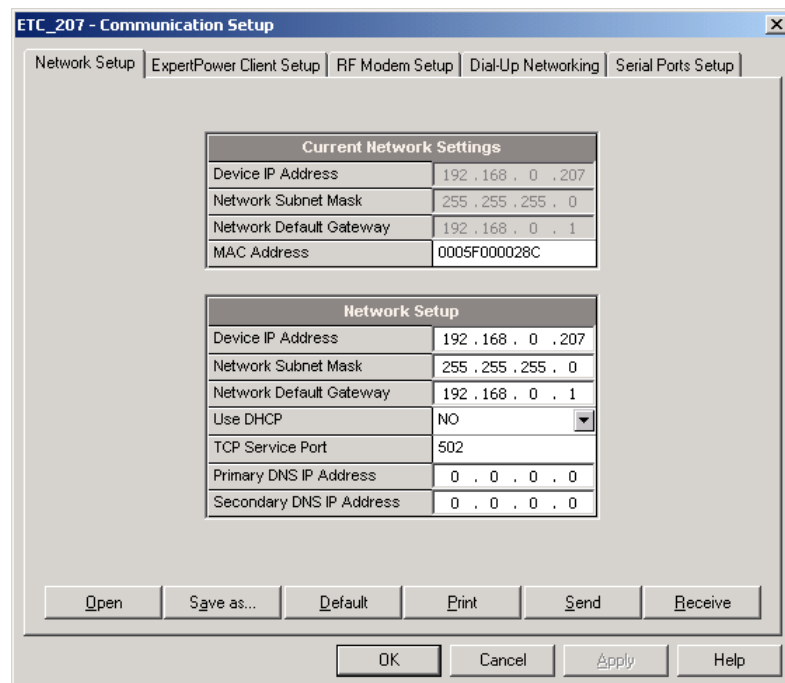

The following table lists available network options.

Parameter	Options	Default
Device IP Address		192.168.0.203

Parameter	Options	Default
Network Subnet Mask		255.255.255.0
Network Default Gateway		192.168.0.1
TCP Service Port	502 = Modbus/TCP 20000 = DNP3/TCP 5002 = SATEC ASCII/TCP	502

NOTE:

Starting with V21.5.4, the ETC II provides the permanent Modbus/TCP server on port 502. Selecting the TCP service port in the ETC II launches an additional server either on the DNP3/TCP port 20000, or on the SATEC ASCII/TCP port 5002, allowing simultaneous connections via the two ports.

Configuring Dial-Up Connections

Using HyperTerminal or Telnet

To view or change the modem settings, type `modem` and press Enter. If you want to change a parameter, type your new setting after the prompt and press Enter. To leave the setting unchanged, just press Enter. Refer to the table below for the available connection options and their description.

```
>modem
Number of dial attempts: 0
New:
Connection timeout (sec): 180
New:
Delay between redials: 1
New:
Idle connection timeout (sec): 60
New:
Rings before answer: 8
New:
Modem init AT command: ATZ0&F
New:
#1 Phone number to dial:
New:
#1 Login name:
New:
#1 Login password: *****
New:
Network IP address: 192.168.10.203
New:
Network subnet mask: 255.255.255.0
New:
Network default gateway: 192.168.10.1
New:
>
```

NOTES:

1. The factory-set modem initialization string should not be changed.
2. The phone number is allowed to contain special characters that may be used to format the dial string and to control a dialing sequence. The following characters may be used within the dial string:

, Dial pause: the modem will pause for a specified
time before dialing the following digits.

- W Wait for dial tone: the modem will wait for a dial tone before dialing the digits following "W".
- @ Wait for silence: the modem will wait for at least 5 seconds of silence before continuing with the next dial string parameter.
- () Ignored: may be used to format the dial string.
- Ignored: may be used to format the dial string.
- <space> Ignored: may be used to format the dial string.

Example: 9W02, 5411000

Using PAS

To enter the Setup dialog, select the ETC II site from the list box on the PAS toolbar, select Communications Setup from the Meter Setup menu, and then click on the Dial-Up Networking Setup tab.

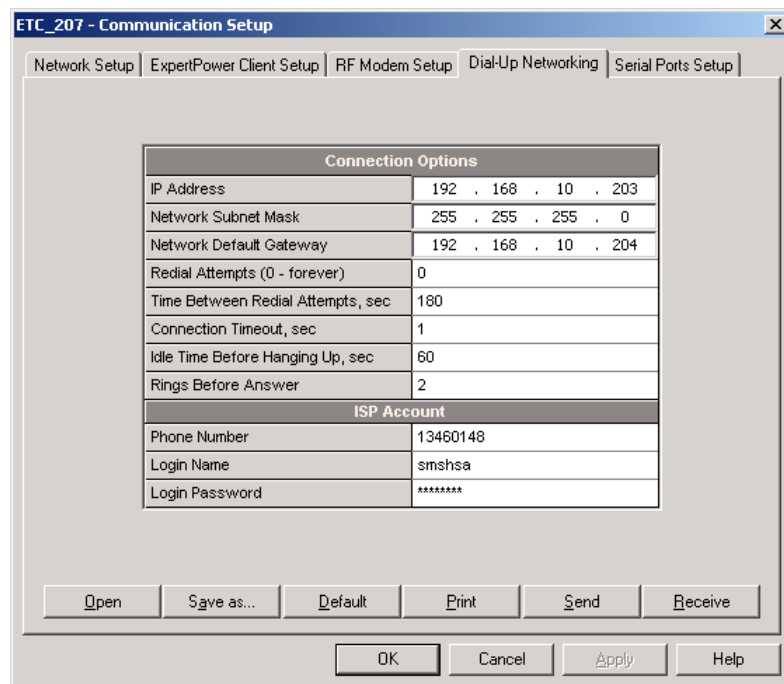

The following table lists available connection options.

Parameter	Options	Default	Description
Dial-in Connection Options			
IP Address		192.168.10.203	The ETC II IP address on the modem PPP network. Use it in your Dial-Up networking applications for connections to the ETC II TCP server.
Network Subnet Mask		255.255.255.0	The ETC II PPP network subnet mask
Network Default Gateway		192.168.10.1	The ETC II PPP network default gateway
Idle Time Before Hanging Up	1-9999 sec	60	The modem disconnects a call if idle for more than the specified idle time.
Rings before Answer	1-99	8	The number of rings before the modem answers an incoming call from a remote modem.

Parameter	Options	Default	Description
Dial-out Connection Options			
Redial Attempts	0-1000, 0 = dial forever	0	The number of dial attempts to connect to a remote modem if a connection was unsuccessful.
Time Between Redial Attempts	0-9999 sec	1	A time delay between redials.
Connection Timeout	0-9999 sec	180	The modem cancels a call if not connected within the connection timeout time.
Idle Time Before Hanging Up	1-9999 sec	60	The modem disconnects a call if idle for more than the specified idle time.
Phone Number			The telephone number of the ISP provider.
Login Name			Login name for logging onto the Internet.
Login Password			Login password for logging onto the Internet.

Configuring Gateway Options

Using HyperTerminal or Telnet

To view or change the ETC II gateway settings, type `mbus` and press Enter. To change a parameter, type your new setting after the prompt and press Enter. To leave the setting unchanged, just press Enter.

```
>mbus
ETC MODBUS ID: 99
New:
Start address: 1
New:
End address: 215
New:
Sharing control Enabled [y/n]: N
New [y/n]:
>
```

See [Routing Messages over Slave Networks](#) in Chapter 3 for information on defining the gateway address range and the ETC II service address. See [Shared Device Access](#) in Chapter 3 for information on shared device accesses.

Using PAS

To enter the Setup dialog, select the ETC II site from the list box on the PAS toolbar, and then select ETC II Setup from the Meter Setup menu.

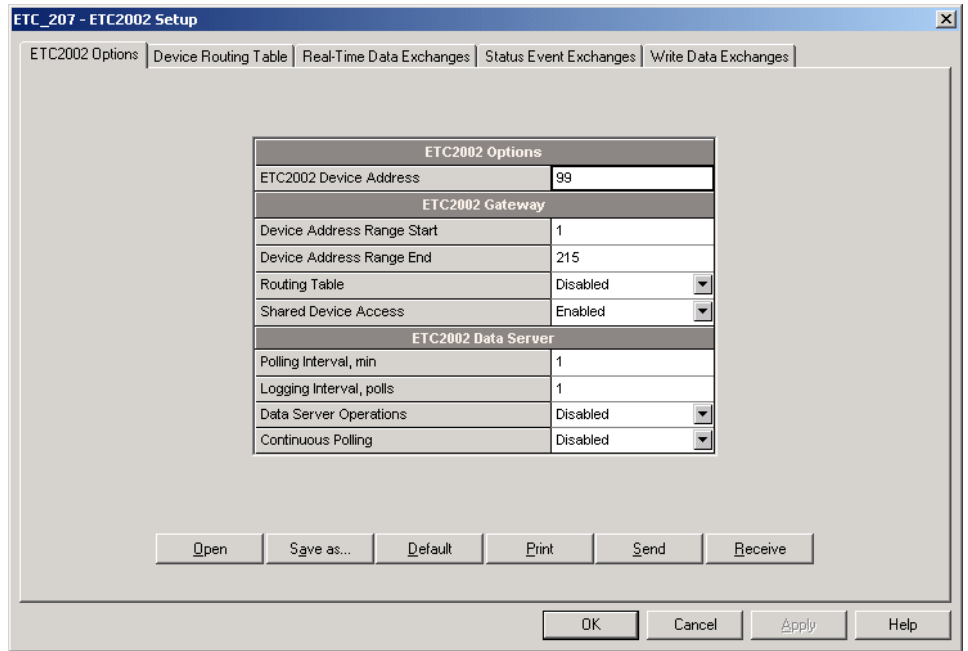

The following table lists available options.

Label	Options	Default	Description
ETC II Device Address	1-247	99	The ETC II network ID
Device Address Range Start	1-247	1	The start slave device address on the gateway
Device Address Range End	1-247	215	The end slave device address on the gateway
Routing Table	Disabled, Enabled	Disabled	Enables using the device routing table
Shared Device Access	Disabled, Enabled	Enabled	Enables multiple accesses to slave devices from a number of clients

Configuring Device Routing Table

Using PAS

To enter the Setup dialog, select the ETC II site from the list box on the PAS toolbar, select ETC II Setup from the Meter Setup menu, and then click on the Device Routing Table tab.

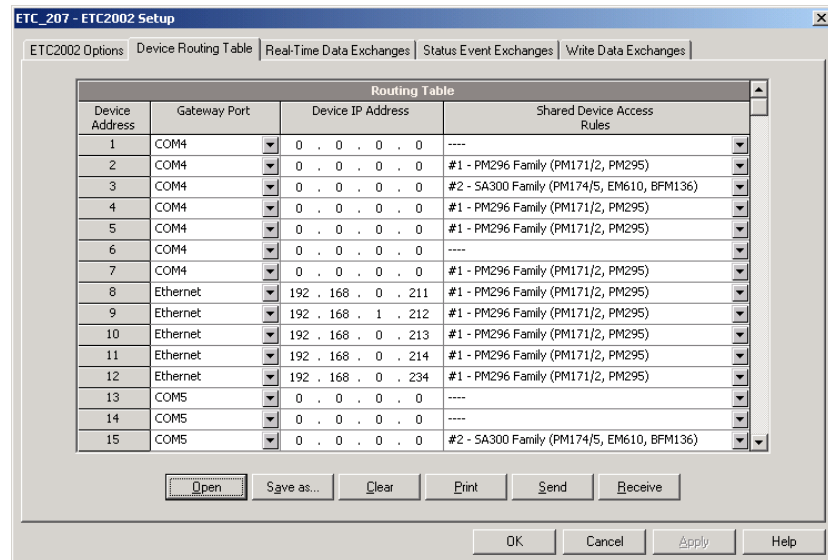

The routing table allows you to specify a routing path and the shared device access rules for every slave device connected to the ETC II. Note that the Ethernet devices can only be accessed via the routing table.

See [Routing Messages over Slave Networks](#) in Chapter 3 for information on using the routing table in the ETC II. See [Shared Device Access](#) in Chapter 3 for information on shared device accesses.

The following table lists available routing options.

Label	Options	Default	Description
Gateway Port	Ethernet, COM4, COM5	COM4	The ETC II port to which the device-addressed messages will be routed
Device IP Address		192.168.0.203	The Ethernet device IP address
Shared Device Access Rules	None – no access limitations, #1 – PM296 family (PM296, PM171, PM172) #2 – SA300 family (SA300, PM174, PM175, EM610, BFM136)	None	Specifies the device-sharing policy for simultaneous client accesses

When selecting the device-sharing policy, select the appropriate rules corresponding to the device family. In this case, the critical device registers will be protected from simultaneous accesses.

NOTE:

Enable the routing table via the ETC II Gateway Options Setup to make it effective in your ETC II (see [Configuring Gateway Options](#) above).

Configuring eXpertPower Client

Using HyperTerminal or Telnet

To view or change the eXpertPower™ settings, type **xp** and press Enter. To change a parameter, type your new setting after the prompt and press Enter. To leave the setting unchanged, just press Enter.

```
>xp
XpertPower IP address: 194.90.237.19
New:
XpertPower TCP service port: 5001
New:
XpertPower client Enabled [y/n]: N
New [y/n]:
Connection period (min): 10
New:
Time to next session: 0
```

See the table below for available options. Refer to your eXpertPower service provider for the correct eXpertPower settings. See [eXpertPower™ Client](#) in Chapter 3 for more information on the eXpertPower™ service.

NOTES

1. If you do not use the eXpertPower™ service, do not enable the eXpertPower client in your ETC II.
2. Do not change the connection period setting. The eXpertPower server updates it automatically.

Using PAS

To enter the Setup dialog, select the ETC II site from the list box on the PAS toolbar, select Communication Setup from the Meter Setup menu, and then click on the ExpertPower Client Setup tab.

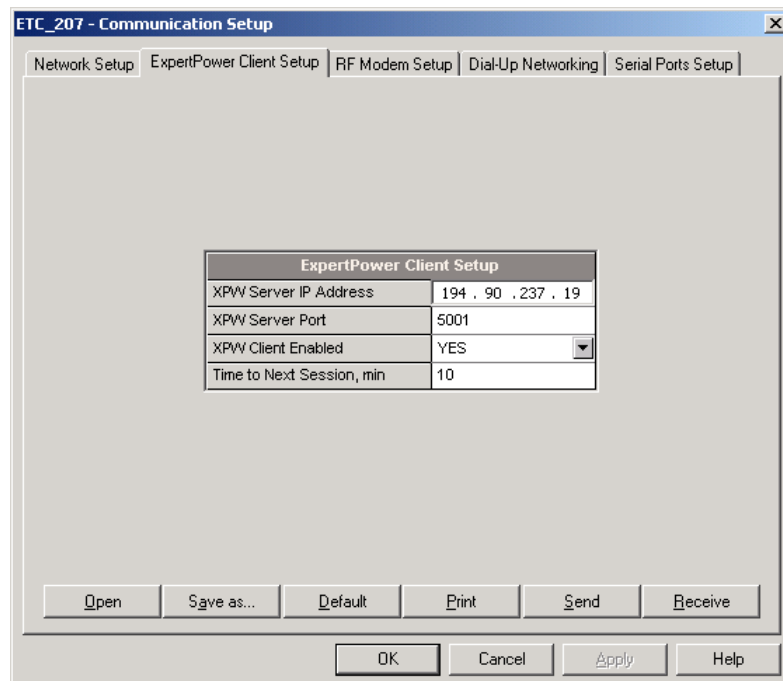

The following table lists available options.

Parameter	Options	Default	Description
XPW Server IP Address		207.232.60.18	The IP address of the eXpertPower server
XPW Server Port	0-65535	5001	The TCP service port of the eXpertPower server
XPW Client Enabled	NO, YES	NO	Enables operations of the eXpertPower client
Time to Next Session, min	1-99999		The time remaining to the next connection session

Configuring Data Server

Using HyperTerminal or Telnet

See [Data Server](#) in Chapter 3 for information on Data server operations.

To view or change the Data server settings, type `datasrv` and press Enter.

```
>datasrv
```

You will be prompted for the password. The factory-set password is 0 unless you have changed it in your ETC II.

```
Enter password:*
```

```
Data Server Configuration Commands
```

```
-----
```

```
h      - Display this text
p      - Server parameters
s [N]  - Set address range *
i [N]  - Display address range settings *
q      - Quit menu
        *(N - address range number)
```

```
Data server>
```

Data Server Options

To view the Data server options, type `i` and press Enter.

```
Data server>i
```

```
Data Server Configuration
```

```
-----
```

```
Data server          disabled
Continuous polling  disabled
Polling interval    1 min
Logging interval    1 (x1min)
```

To setup or change the Data server options, type `p` and press Enter. To change an option, type your new setting after the prompt and press Enter. To leave the setting unchanged, just press Enter. Refer to the table below for the available options and their explanation.

```
Data server>p
```

```
Data server: disabled
```

```
New [y/n]:
```

```
Continuous polling: disabled
```

```
New [y/n]:
```

```
Polling interval: 1 min
```

```
New:
```

Logging interval: 1 (in polling interval units)

New:

Data Server Exchanges

See [Data Server](#) in Chapter 3 for more information on using Data server exchanges.

To inspect the present configuration (to leave the settings unchanged, just press Enter) or configure the Data server exchanges:

1. Type `s` and press Enter. The following prompt appears:

```
Data server>s
```

```
Data Exchange No:
```

2. Type the data exchange number, and then specify the device address, the start device register and the number of registers in the real-time data exchange. Note that the real-time, status event and write data exchanges with the same exchange number are internally linked in the ETC II to the same device address.

```
Device ID: 1
```

```
New:
```

```
Start device register address: 256
```

```
New:
```

```
Number of registers: 1
```

```
New:
```

3. Enable real-time polling for the exchange if you want to start exchange operations:

```
Polling: enabled
```

```
New [y/n]:
```

4. Enable updating the real-time clock in the device if you wish to periodically synchronize its clock with the ETC II clock:

```
RTC update: disabled
```

```
New [y/n]:
```

5. Specify the start device register and the number of registers in the write data exchange:

```
Write block start register address: 200
```

```
New:
```

```
Number of registers: 10
```

```
New:
```

6. Enable polling for the write data exchange if you want to start exchange operations:

```
Polling: disabled
```

```
New [y/n]:
```

7. Specify the device status register and a register mask for a status event exchange:

```
Status register address: 400
```

```
New:
```

```
Status register mask: 0xC000 (HEX)
```

```
New:
```

8. Enable polling for the status event exchange if you want to start exchange operations:

```
Status polling: disabled
```

```
New [y/n]:
```

9. Enable the auto-reset option, if you wish the register to be automatically cleared after it has been read:

Status register auto-reset: disabled

New [y/n]:

10. Enable using Modbus Request 1 if you wish the register to be read as coils:

Register type: holding

New [coil/holding]:

Data server>

11. Type q to quit the Data server menu.

Using PAS

Data Server Options

To enter the Setup dialog, select the ETC II site from the list box on the PAS toolbar, and then select ETC II Setup from the Meter Setup menu.

ETC2002 Options	
ETC2002 Device Address	99
ETC2002 Gateway	
Device Address Range Start	1
Device Address Range End	215
Routing Table	Disabled
Shared Device Access	Enabled
ETC2002 Data Server	
Polling Interval, min	1
Logging Interval, polls	1
Data Server Operations	Enabled
Continuous Polling	Disabled

The following table lists available Data server options.

Parameter	Options	Default	Description
Polling Interval	1-1000 min	1 min	Specifies the interval for periodic polling connected devices
Logging Interval, polls	0-1000, 0=logging disabled	1	A non-zero interval enables recording the acquired data to the log file at predefined intervals
Data Server Operations	Disabled, Enabled	Disabled	Enables Data server operations
Continuous Polling	Disabled, Enabled	Disabled	If enabled, the Data server polls devices continuously without taking the polling interval into account.

See [Data Server](#) in Chapter 3 for more information on using the Data server.

Real-Time Data Exchanges

To enter the Setup dialog, select the ETC II site from the list box on the PAS toolbar, select ETC II Setup from the Meter Setup menu, and then click on the Real-Time Data Exchanges tab.

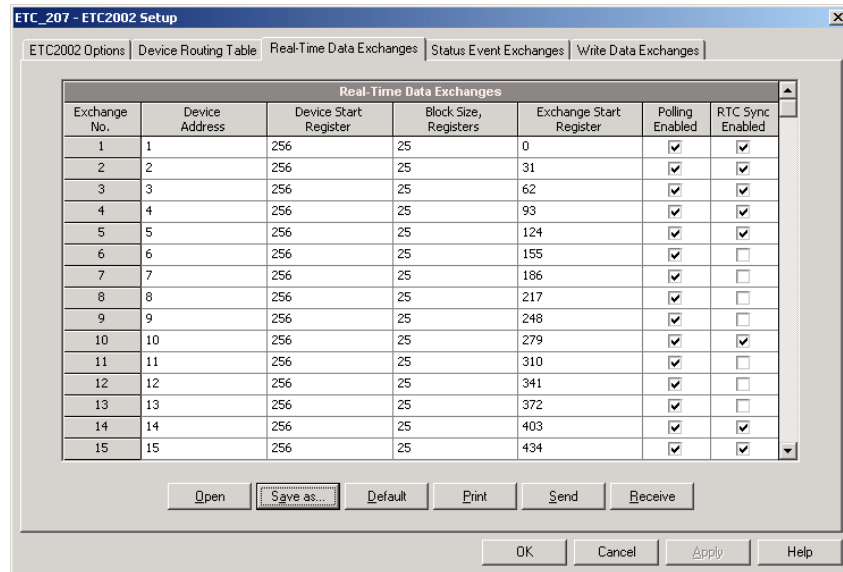

See [Data Server](#) in Chapter 3 for more information on using real-time data exchanges. Refer to the ETC II Modbus Guide for information on how to access the acquired real-time and logged data via communications.

The following table lists available options.

Parameter	Options	Default	Description
Device Address	1-247	1	Defines the device to which the exchange is linked
Device Start Register	0-65535	0	Defines the start device register for real-time polling
Block Size	1-114	0	Defines the number of contiguous registers in the exchange
Polling Enabled	Disabled, Enabled	Disabled	Enables polling the device
RTC Sync Enabled	Disabled, Enabled	Disabled	If enabled, the Data server synchronizes the device clock with the ETC II clock

To configure a real-time data exchange:

1. Define the device address for a data exchange. Note that the real-time, status event and write data exchanges with the same exchange number are internally linked in the ETC II to the same device address.
2. Specify the start register address of the area in the device Modbus map you wish to be polled via the exchange.
3. Type the number of registers in the exchange. Up to 114 registers can be specified for a single exchange. As you type the register address range, PAS immediately shows you the start register address in the ETC II exchange area for accessing the acquired data from the remote applications.
4. Check the "Polling Enabled" box to activate the exchange.

Status Event Exchanges

To enter the Setup dialog, select the ETC II site from the list box on the PAS toolbar, select ETC II Setup from the Meter Setup menu, and then click on the Status Event Exchanges tab.

Exchange No.	Status Register		Event Mask (Binary/Hex)																Hex	Polling Enabled	Auto Reset	Register Type	
	Device Address	Register Address	15	14	13	12	11	10	9	8	7	6	5	4	3	2	1	0					
1	1	3455	<input type="checkbox"/>	<input type="checkbox"/>	<input type="checkbox"/>	<input type="checkbox"/>	<input type="checkbox"/>	<input type="checkbox"/>	<input type="checkbox"/>	<input type="checkbox"/>	<input type="checkbox"/>	<input type="checkbox"/>	<input type="checkbox"/>	<input type="checkbox"/>	<input type="checkbox"/>	<input type="checkbox"/>	<input type="checkbox"/>	<input checked="" type="checkbox"/>	<input checked="" type="checkbox"/>	0x000F	<input checked="" type="checkbox"/>	<input type="checkbox"/>	Holding
2	1	3475	<input type="checkbox"/>	<input type="checkbox"/>	<input checked="" type="checkbox"/>	<input type="checkbox"/>	<input type="checkbox"/>	<input type="checkbox"/>	<input type="checkbox"/>	<input type="checkbox"/>	<input type="checkbox"/>	<input type="checkbox"/>	<input type="checkbox"/>	<input type="checkbox"/>	<input type="checkbox"/>	<input type="checkbox"/>	<input type="checkbox"/>	<input type="checkbox"/>	<input checked="" type="checkbox"/>	0x2100	<input checked="" type="checkbox"/>	<input checked="" type="checkbox"/>	Holding
3	2	3455	<input type="checkbox"/>	<input type="checkbox"/>	<input type="checkbox"/>	<input type="checkbox"/>	<input type="checkbox"/>	<input type="checkbox"/>	<input type="checkbox"/>	<input type="checkbox"/>	<input type="checkbox"/>	<input type="checkbox"/>	<input type="checkbox"/>	<input type="checkbox"/>	<input type="checkbox"/>	<input type="checkbox"/>	<input type="checkbox"/>	<input type="checkbox"/>	<input checked="" type="checkbox"/>	0x000F	<input checked="" type="checkbox"/>	<input type="checkbox"/>	Holding
4	2	3475	<input type="checkbox"/>	<input type="checkbox"/>	<input checked="" type="checkbox"/>	<input type="checkbox"/>	<input type="checkbox"/>	<input type="checkbox"/>	<input type="checkbox"/>	<input type="checkbox"/>	<input type="checkbox"/>	<input type="checkbox"/>	<input type="checkbox"/>	<input type="checkbox"/>	<input type="checkbox"/>	<input type="checkbox"/>	<input type="checkbox"/>	<input type="checkbox"/>	<input checked="" type="checkbox"/>	0x2100	<input checked="" type="checkbox"/>	<input checked="" type="checkbox"/>	Holding
5	3	3455	<input type="checkbox"/>	<input type="checkbox"/>	<input type="checkbox"/>	<input type="checkbox"/>	<input type="checkbox"/>	<input type="checkbox"/>	<input type="checkbox"/>	<input type="checkbox"/>	<input type="checkbox"/>	<input type="checkbox"/>	<input type="checkbox"/>	<input type="checkbox"/>	<input type="checkbox"/>	<input type="checkbox"/>	<input type="checkbox"/>	<input type="checkbox"/>	<input checked="" type="checkbox"/>	0x0007	<input checked="" type="checkbox"/>	<input type="checkbox"/>	Holding
6	3	3475	<input type="checkbox"/>	<input type="checkbox"/>	<input checked="" type="checkbox"/>	<input type="checkbox"/>	<input type="checkbox"/>	<input type="checkbox"/>	<input type="checkbox"/>	<input type="checkbox"/>	<input type="checkbox"/>	<input type="checkbox"/>	<input type="checkbox"/>	<input type="checkbox"/>	<input type="checkbox"/>	<input type="checkbox"/>	<input type="checkbox"/>	<input type="checkbox"/>	<input checked="" type="checkbox"/>	0x2100	<input checked="" type="checkbox"/>	<input checked="" type="checkbox"/>	Holding
7	4	3455	<input type="checkbox"/>	<input type="checkbox"/>	<input type="checkbox"/>	<input type="checkbox"/>	<input type="checkbox"/>	<input type="checkbox"/>	<input type="checkbox"/>	<input type="checkbox"/>	<input type="checkbox"/>	<input type="checkbox"/>	<input type="checkbox"/>	<input type="checkbox"/>	<input type="checkbox"/>	<input type="checkbox"/>	<input type="checkbox"/>	<input type="checkbox"/>	<input checked="" type="checkbox"/>	0x0007	<input checked="" type="checkbox"/>	<input type="checkbox"/>	Holding
8	4	3475	<input type="checkbox"/>	<input type="checkbox"/>	<input checked="" type="checkbox"/>	<input type="checkbox"/>	<input type="checkbox"/>	<input type="checkbox"/>	<input type="checkbox"/>	<input type="checkbox"/>	<input type="checkbox"/>	<input type="checkbox"/>	<input type="checkbox"/>	<input type="checkbox"/>	<input type="checkbox"/>	<input type="checkbox"/>	<input type="checkbox"/>	<input type="checkbox"/>	<input checked="" type="checkbox"/>	0x2100	<input checked="" type="checkbox"/>	<input checked="" type="checkbox"/>	Holding
9	5	3455	<input type="checkbox"/>	<input type="checkbox"/>	<input type="checkbox"/>	<input type="checkbox"/>	<input type="checkbox"/>	<input type="checkbox"/>	<input type="checkbox"/>	<input type="checkbox"/>	<input type="checkbox"/>	<input type="checkbox"/>	<input type="checkbox"/>	<input type="checkbox"/>	<input type="checkbox"/>	<input type="checkbox"/>	<input type="checkbox"/>	<input type="checkbox"/>	<input checked="" type="checkbox"/>	0x000F	<input checked="" type="checkbox"/>	<input type="checkbox"/>	Holding
10	5	3475	<input type="checkbox"/>	<input type="checkbox"/>	<input checked="" type="checkbox"/>	<input type="checkbox"/>	<input type="checkbox"/>	<input type="checkbox"/>	<input type="checkbox"/>	<input type="checkbox"/>	<input type="checkbox"/>	<input type="checkbox"/>	<input type="checkbox"/>	<input type="checkbox"/>	<input type="checkbox"/>	<input type="checkbox"/>	<input type="checkbox"/>	<input type="checkbox"/>	<input checked="" type="checkbox"/>	0x2100	<input checked="" type="checkbox"/>	<input checked="" type="checkbox"/>	Holding
11	6	3455	<input type="checkbox"/>	<input type="checkbox"/>	<input type="checkbox"/>	<input type="checkbox"/>	<input type="checkbox"/>	<input type="checkbox"/>	<input type="checkbox"/>	<input type="checkbox"/>	<input type="checkbox"/>	<input type="checkbox"/>	<input type="checkbox"/>	<input type="checkbox"/>	<input type="checkbox"/>	<input type="checkbox"/>	<input type="checkbox"/>	<input type="checkbox"/>	<input checked="" type="checkbox"/>	0x000F	<input checked="" type="checkbox"/>	<input type="checkbox"/>	Holding
12	6	3475	<input type="checkbox"/>	<input type="checkbox"/>	<input checked="" type="checkbox"/>	<input type="checkbox"/>	<input type="checkbox"/>	<input type="checkbox"/>	<input type="checkbox"/>	<input type="checkbox"/>	<input type="checkbox"/>	<input type="checkbox"/>	<input type="checkbox"/>	<input type="checkbox"/>	<input type="checkbox"/>	<input type="checkbox"/>	<input type="checkbox"/>	<input type="checkbox"/>	<input checked="" type="checkbox"/>	0x2100	<input checked="" type="checkbox"/>	<input type="checkbox"/>	Holding
13	7	3455	<input type="checkbox"/>	<input type="checkbox"/>	<input type="checkbox"/>	<input type="checkbox"/>	<input type="checkbox"/>	<input type="checkbox"/>	<input type="checkbox"/>	<input type="checkbox"/>	<input type="checkbox"/>	<input type="checkbox"/>	<input type="checkbox"/>	<input type="checkbox"/>	<input type="checkbox"/>	<input type="checkbox"/>	<input type="checkbox"/>	<input type="checkbox"/>	<input checked="" type="checkbox"/>	0x0007	<input checked="" type="checkbox"/>	<input type="checkbox"/>	Holding
14	7	3475	<input type="checkbox"/>	<input type="checkbox"/>	<input checked="" type="checkbox"/>	<input type="checkbox"/>	<input type="checkbox"/>	<input type="checkbox"/>	<input type="checkbox"/>	<input type="checkbox"/>	<input type="checkbox"/>	<input type="checkbox"/>	<input type="checkbox"/>	<input type="checkbox"/>	<input type="checkbox"/>	<input type="checkbox"/>	<input type="checkbox"/>	<input type="checkbox"/>	<input checked="" type="checkbox"/>	0x2100	<input checked="" type="checkbox"/>	<input checked="" type="checkbox"/>	Holding

See [Data Server](#) in Chapter 3 for more information on using status event exchanges. Refer to the ETC II Modbus Guide for information on how to access the event log data via communications.

The following table lists available options.

Parameter	Options	Default	Description
Device address	1-247	1	Defines the device to which the exchange is linked
Register Address	0-65535	0	Defines the device status event register address for polling
Event Mask	0-0xFFFF	0	Defines the bit mask for bits which status must be checked for events
Polling Enabled	Disabled, Enabled	Disabled	Enables polling the status register
Auto Reset	Disabled, Enabled	Disabled	If enabled, the Data server clears the device register after it has been read

To configure a status event exchange:

1. Define the device address for a status event exchange. Note that the real-time, status event and write data exchanges with the same exchange number are internally linked in the ETC II to the same device address.
2. Specify the device status register address you wish to be polled via the exchange.
3. Specify the event mask for bits you wish to be checked for events.
4. Check the "Polling Enabled" box to activate the exchange.
5. Check the "Auto Reset" box if you want the status register to be cleared after polling.

Write Data Exchanges

To enter the Setup dialog, select the ETC II site from the list box on the PAS toolbar, select ETC II Setup from the Meter Setup menu, and then click on the Write Data Exchanges tab.

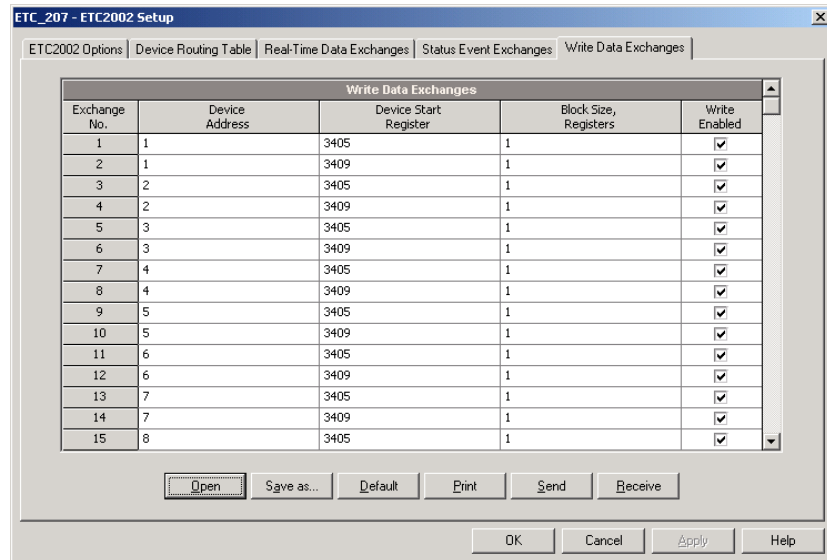

See [Data Server](#) in Chapter 3 for more information on using data exchanges. Refer to the ETC II Modbus Guide for information on how to put data into a write exchange and to trigger it via communications.

The following table lists available options.

Parameter	Options	Default	Description
Device address	1-247	1	Define the device to which the exchange is linked
Device Start Register	0-65535	0	Defines the start device register for a write
Block Size	1-12	0	Defines the number of contiguous registers in the write exchange
Write Enabled	Disabled, Enabled	Disabled	Enables writing data to the device upon a trigger

To configure a write data exchange:

1. Define the device address for a write data exchange. Note that the real-time, status event and write data exchanges with the same exchange number are internally linked in the ETC II to the same device address.
2. Specify the start register address of the area in the device Modbus map you wish to be written via the exchange.
3. Type the number of contiguous registers in the exchange.
4. Check the "Write Enabled" box to activate the exchange.

Chapter 6 Upgrading Device Firmware

This chapter describes the procedure of upgrading firmware in the ETC II through the COM3 RS-232 service port using Windows HyperTerminal.

When you put your device into program mode, its COM3 port operates at 19200 baud by default. Downloading firmware at a slow baud rate may be very time-consuming. It is recommended to use the maximum available speed of 115200 baud for downloading firmware. Prepare a HyperTerminal session file for communicating with the ETC II at 115200 baud before you start upgrading firmware in your device. See [Using HyperTerminal](#) in Chapter 4 for information on preparing a session file for HyperTerminal.

Opening a Terminal Session

1. Connect your PC to the ETC II COM3 RS-232 port using the standard RS-232 DTE-DTE (null-modem) cable that came with your ETC II.
2. Run a HyperTerminal session. See [Using HyperTerminal](#) in Chapter 4 for information on launching and configuring HyperTerminal.

Put the PROG-RUN key on the front of the ETC II in the PROG position.

Downloading Firmware to the Device

1. Print `loader` and press Enter. The following text appears:

```
>loader
```

```
Are you sure you want to run Boot Loader now?  
[y/n]: y
```

2. Enter `y` and press Enter. The following text appears:

```
The ETC II will stop operations!  
Run anyway? [y/n]: y
```

3. Enter `y` and press Enter. The Flash Loader is launched and prints a list of the available commands as follows:

```
ETC II Flash Loader Ver.1.2.1  
Copyright (C) 2003, SATEC Ltd.  
Firmware information  
-----  
Bootloader: Version 1.2.1, size 20512 bytes,  
checksum 0x227E  
Main program: Version 10.2.8, size 336260bytes,  
checksum 0x38A3  
Flash Loader commands  
-----  
h - Display this text  
i - Display boot information  
b - Display/change baud rate  
p - Download a program into Flash  
v - Verify a program  
n - NIC Configurator  
q - Quit Flash Loader and restart a program  
>
```

4. Print `b` and press Enter.

```
>b  
Baud Rate: 19200
```

New: 115200

5. Print 115200 and press Enter. Now the Flash Loader communicates at 115200 baud.
6. To accommodate HyperTerminal to the new baud rate, select Open from the File menu, click Yes in response to the HyperTerminal question, and then double-click on your "115200" session file.
7. Print **p** and press Enter. The following text appears:

p

Programming Flash

Send HEX-32 file as a text file.

NB: Use standard XON/XOFF flow control.

NB: Ensure that LF is not stripped at the end of lines.

To abort downloading, press Esc.

0 characters received...

8. From the Transfer menu, select Send Text File, and then select "All files (*.*)" in the "File of type" box. On the file pane, point to your new firmware image HEX file and click Open. HyperTerminal starts the file transfer.

When downloading is complete, the following message appears:

Downloading complete. 924836 characters received.

336260 bytes written into Flash.

>

If downloading fails, repeat steps 7 and 8 again.

Chapter 7 Device Maintenance

This chapter describes the battery replacement procedure. See Figures 7-1 to 7-4 for replacement instructions.

△ Observe the battery polarity. The battery polarity appears on the inner part of the battery cover.



Figure 7-1 Battery Housing Location of the Panel



Figure 7-2 Battery Housing Cover Removal



Figure 7-3 Battery Removal



Figure 7-4 Insertion of New Battery

Appendix Technical Specifications

Environmental Conditions

Operating temperature: -20°C to 60°C (-4°F to 140°F)

Storage temperature: -40°C to 85°C (-13°F to 176°F)

Humidity: 0 to 95% non-condensing

Construction

Dimensions: see Figure 2-1

Weight: 1.23kg (2.7 lb.)

Materials

Enclosure: Aluminum

Terminals: PBT (UL94-V0)

Connectors: plug-in type, Polyamide PA6.6 (UL94-V0)

Packaging case: Carton and Stratocell® (Polyethylene Foam) brackets

Power Supply

120/230 VAC, 50/60 Hz: Rated input: 85-265 VAC

120/220 VDC Option: Rated input 88-290VDC,

Burden: 10W

Isolation: 3200 VRMS

12 VDC Option: Rated input 9.6-19 VDC

24 VDC Option: Rated input 19-37 VDC

48 VDC Option: Rated input 37- 72 VDC

Burden: 10W

Isolation (except 12VDC): 1350 VRMS

Wire size: up to 12 AWG (up to 2.5 mm²)

Communication Ports

COM1 Ethernet Port

Transformer-isolated 10/100BaseT Ethernet port.

Connector type: RJ45 modular.

Supported protocols: Modbus/TCP (port 502), SATEC ASCII/TCP (port 5001), and DNP3/TCP (port 20000).

Number of simultaneous connections: 5.

COM2 CELLULAR Modem (future)

2G/3G Cellular Data Network

Connector type: SMA

COM3 Serial EIA RS-232 optically isolated port

Isolation: 2,000 V RMS

Connector type: DB9 female

Baud rate: up to 115.2 kbps

Supported protocols: Modbus RTU, Modbus ASCII and DNP3

COM4, COM5 RS-422/RS-485 optically isolated ports

Isolation: 2,000 V RMS

Connector type: removable, 5 pins

Wire size: up to 12 AWG (up to 2.5 mm²)

Terminals pitch: 5 mm

Baud rate: up to 115.2 kbps

Supported protocols: Modbus RTU, SATEC ASCII and DNP3

Real-time Clock

Accuracy: typical error 15 seconds per month @ 25°C

Log Memory

Onboard memory with battery backup: 4 Mbytes.