

# expertmeter™

## EM720

### POWER QUALITY AND REVENUE METER Installation Manual

---



## LIMITED WARRANTY

The manufacturer offers the customer a 24-month functional warranty on the instrument for faulty workmanship or parts from date of dispatch from the distributor. In all cases, this warranty is valid for 36 months from the date of production. This warranty is on a return to factory basis.

The manufacturer does not accept liability for any damage caused by instrument malfunction. The manufacturer accepts no responsibility for the suitability of the instrument to the application for which it was purchased.

Failure to install, set up or operate the instrument according to the instructions herein will void the warranty.

Only a duly authorized representative of the manufacturer may open your instrument. The unit should only be opened in a fully anti-static environment. Failure to do so may damage the electronic components and will void the warranty.

### NOTE

The greatest care has been taken to manufacture and calibrate your instrument. However, these instructions do not cover all possible contingencies that may arise during installation, operation or maintenance, and all details and variations of this equipment are not covered by these instructions.

For additional information regarding installation, operation or maintenance of this instrument, contact the manufacturer or your local representative or distributor.

### IMPORTANT

**Please read the instructions in this manual before performing installation, and take note of the following precautions:**

1. **Ensure that all incoming AC power and other power sources are turned OFF** before performing any work on the instrument. Failure to do so may result in serious or even fatal injury and/or equipment damage.
2. **Before connecting the instrument to the power source, check** the labels on the front of the instrument to ensure that your instrument is equipped with the appropriate power supply voltage, input voltages and currents for your application.
3. **Do not** connect the instrument to a power source if it is damaged.
4. **Do not** expose the instrument to rain or moisture.
5. **The secondary of an external current transformer must never be** allowed to be open circuit when the primary is energized. An open circuit can cause high voltages, possibly resulting in equipment damage, fire and even serious or fatal injury. Ensure that the current transformer wiring is made through shorting switches and is secured using an external strain relief to reduce mechanical strain on the screw terminals, if necessary.
6. **Only qualified personnel familiar with the instrument and its associated electrical equipment must perform setup procedures.**
7. **DO NOT** open the instrument under any circumstances.

 **Read this manual thoroughly before connecting the meter to the current carrying circuits. During operation of the meter, hazardous voltages are present on input terminals. Failure to observe precautions can result in serious or even fatal injury or damage to equipment.**

# Table of Contents

- Chapter 1 Introduction ..... 1
  - About This Manual..... 1
  - About The EM720..... 1
- Chapter 2 Installation ..... 3
  - Mechanical Installation ..... 3
  - Electrical Installation ..... 5
    - Primary electrical installation .....5
    - Voltage Inputs.....6
    - Current Inputs.....6
    - Signal Ground Input.....6
    - Connectors location .....6
    - Typical Installation .....7
    - Wiring Configurations .....8
    - Input / Output ports options.....12
    - Communications options .....14
    - Auxiliary Power Supply .....18
    - Location of Modules.....19
- Chapter 3 Communications ..... 20
- Chapter 4 Replacing the Battery..... 21
- Appendix: Technical Specifications ..... 22
  - Inputs Ratings..... 22
  - Power Supply ..... 24
  - Input/Output ports ..... 24
  - Communication ports..... 25
  - Console Display Unit ..... 26
  - Real Time Clock ..... 26
  - Log Memory..... 26
  - Environmental Conditions ..... 26
  - Construction ..... 26
  - Standards Compliance ..... 27
  - Measurement Specifications..... 28

# FIGURES

Figure 1: Dimensions.....	3
Figure 2: Wall mount dimensions.....	4
Figure 3: Memory Backup Lithium Battery and Battery Pack Installation .....	5
Figure 4: EM720 Connectors view .....	6
Figure 5: Typical Electrical Installation.....	7
Figure 6: Three Wire Using 2 CTs - Wiring Setup: 3dir2 .....	8
Figure 7: Four Wire WYE Connection Using 3(4) CTs - Wiring Setup: 4LL3 or 4Ln3 .....	9
Figure 8: Four Wire WYE Connection Using 3 PTs, 3 (4) CTs - Wiring Setup: 4LL3 or 4Ln3 .....	9
Figure 9: Three Wire Open Delta Connection Using 2 PTs, 2 CTs - Wiring Setup: 3OP2 .....	10
Figure 10: Three Wire Wye Connection Using 2 PTs, 3 CTs - Wiring Setup: 3LL3 or 3Ln3 .....	10
Figure 11: Three Wire Open Delta Connection Using 2 PTs, 3 CTs - Wiring Setup: 3OP3 .....	11
Figure 12: Four Wire Delta Connection Using 3 CTs - Wiring Setup: 4LL3 or 4Ln3 .....	11
Figure 13: Digital Input Connection.....	12
Figure 14: 2DI/2DO Connection.....	13
Figure 15: Infrared Communication port - COM1 .....	14
Figure 16: GSM/GPRS Communication port - COM2 .....	14
Figure 17: Serial Communication Network Connection - RS-485 COM3.....	15
Figure 18: Serial Communication Connection - RS-232 COM3.....	16
Figure 19: 10/100BT Ethernet RJ45 Connection.....	16
Figure 20: Mini-USB device Connection .....	17
Figure 21: Auxiliary DC Power Supply Connection .....	18
Figure 22: Modules Front panel side.....	19
Figure 23: Modules connectors side .....	19
Figure 24: RS-232 Simple 3-wire Connection , 25-pin or 9-pin PC COM Port.....	20
Figure 25: RS-485 Multidrop Connection, 25-pin or 9-pin PC COM Port.....	20
Figure 26: Front covers removing .....	21
Figure 27: Battery Housing cover removing .....	21
Figure 28: Replacing the 3.6V Lithium Battery.....	21

# TABLES

Table 1: Wiring Configuration .....	8
Table 2: Auxiliary Terminal Block.....	12

# Chapter 1 Introduction

## About This Manual

This manual is intended to assist the user in the installation of the *eXpertmeter™ EM720 POWER QUALITY REVENUE METER Unit*. The term 'EM720' is used herein to refer to all models in the series.

This chapter gives an overview of this manual and an introduction to the EM720.

Chapter 2, *Installation*, provides instructions for mechanical and electrical installation.

Chapter 3, *Communications*, provides drawings for communications connections and instructions for printing electrical parameter readings.

Technical Specifications for the EM720 are found in the *Appendix*.

## About The EM720

The EM720 series is a group of state-of-art multi-microprocessor-based digital instruments that incorporate the capabilities of a power quality analyzer, energy meter, fault and data recorder and programmable controller, oriented for substation, industrial and commercial areas. These instruments provide three-phase measurements of electrical quantities in power distribution systems, monitoring external events, operating external equipment via relay contacts, fast and long-term on-board recording of measured quantities, transient voltages measurements up to 2KV, fault recording of currents up to 50A, harmonic analysis and disturbance recording.

The unit is available in three models:

- EM720 - Basic model - offers energy meter class 0.2S, IEC Power Quality Analyzer according to EN50160 Standard, all the basic metering, control, and fault and event recording capabilities
- EM720T - Transient Recorder model - adds transient recording capabilities
- EM720U - IEEE Power Quality model - based on IEEE 1159 Standard instead of EN50160 Standard

## Features

The EM720 combines in a single enclosure:

- Precise Class 0.2S Active Energy and Power Demand Meter, Multiple Tariffs & Time-Of-Use (TOU, 16 Summary energy and demand registers for substation energy management, accumulation of energy pulses from external watt-meters, block and sliding demands), transformer and line losses, unique anti-tampering and self-test functions
- State of the art Power Quality Recorder (onboard PQ analyzer according to EN50160; programmable thresholds and hysteresis; ready-for-use reports; sags/swells, interruptions, frequency variations; flicker, temporary overvoltages, transient overvoltages, voltage unbalance, harmonic and interharmonics voltages)
- Digital Fault Recorder (onboard fault detector - programmable fault thresholds and hysteresis, up to 50 Amps fault currents, zero-sequence currents and volts, current and volt unbalance; under-voltage, neutral current; ready-for-use fault reports - fault currents magnitude and duration, coincident volts magnitude, fault waveforms and RMS trace)
- Event Recorder for logging internal diagnostics events, control events and I/O operations
- Four fast Waveform Recorders; selectable AC sampling rate of 32 - 1024 samples per cycle; 20 pre-fault cycles, 1-ms resolution for digital inputs; up to 3 min of continuous recording with an 8 M-byte onboard memory at a rate of 32 samples per cycle, expandable up to 16 M-byte at meter shop
- Sixteen fast Data Recorders (from ½ cycle RMS to 2-hour RMS envelopes; up to 20 pre-fault cycles; programmable data logs on a periodic basis and on any internal and external trigger)
- Programmable Controller (32 control setpoints, OR/AND logic, extensive triggers, programmable thresholds and delays, relay control, event-driven data recording)
- High-Class 3-phase Power meter (true RMS of volts and amps, powers, power factors, neutral current)
- Demand Meter (amps, volts, harmonic demands)
- Harmonic Analyzer (to 128<sup>th</sup> harmonic volts and amps, directional power harmonics and power factor, phasors, symmetrical components)
- 16 programmable timers from ½ cycle to 24 hours for periodic recording and triggering operations on a time basis
- Low and High range isolated Three-Phase Power Supply unit from the measured voltage inputs, according to the voltage measurement input range:
  - Low Range measurement input nominal rating: 57.7V AC to 120V AC (L-N)
  - High Range measurement input nominal rating: 230V AC to 277V AC (L-N)
- NiMH rechargeable backup power supply unit.
- Optional Low DC Auxiliary power supply unit
- Three slots for hot swap field installable option modules
- Graphic LCD display

### ***AC/DC Inputs***

- Three AC voltage inputs - up to 480VAC direct line-to-line input voltage, for feeding and measurement
- Three isolated AC voltage inputs - up to 2KV peak direct line-to-ground and neutral-to-ground input voltage
- Four standard isolated AC current inputs - 5A nominal input currents and up to 50 A fault overload current
- Optional isolated low DC power supply input - up to 4KV AC insulation withstanding

### ***Input/Outputs Options***

The *EM720* is equipped with four fast digital inputs (DI), in the basic instrument, two digital inputs (DI) and two digital outputs in optional plug-in module (2DI/2DO module)

- DI (basic) - 4 Digital inputs - optically isolated input; dry contact, programmable de-bounce time from 1 ms to 1 sec; free linkage to Sequence-of-Events Recorder, Fault Recorder, control setpoints, pulse counters and Energy/TOU subsystem)
- DI (module) - 2 Digital inputs - optically isolated input; dry contact, programmable sampling rate from ½ cycle to 1 sec; control setpoints, pulse counters and Energy/TOU subsystem)
- DO - 2 Relay outputs - mechanic or solid-state relay, unlatched, latched and pulse operations, failsafe operation for alarm notifications; programmable pulse width; direct remote relay control through communications

### ***Communications Options***

The *EM720* has extensive communications capabilities:

- Infrared port (Modbus RTU/ASCII and DNP3.0 protocols)
- Versatile RS-232/485 universal serial communications port (up to 115,200 bps, Modbus RTU/ASCII and DNP3.0 protocols)
- Ethernet 10/100 Base-T port (Modbus/TCP or DNP3.0/TCP protocols, up to five non-intrusive simultaneous connections, Telnet service port)
- USB 1.1 full speed device port (Modbus RTU protocol, 12 Mbps) for fast local communications and data retrieving
- Cellular GPRS modem (Modbus/TCP or DNP3.0/TCP protocols)
- 1-ms satellite-synchronized clock - IRIG-B format time-code input

### ***Upgradeable Firmware***

The *EM720* uses flash memory for storing device firmware that allows future upgrading of the device without replacing any hardware component. The new features can be easily added to your device by simply replacing the firmware through a local RS-232/RS-485, USB port or Ethernet port.

# Chapter 2 Installation

## Mechanical Installation

Refer to the figures provided in this section to properly perform the mechanical installation.

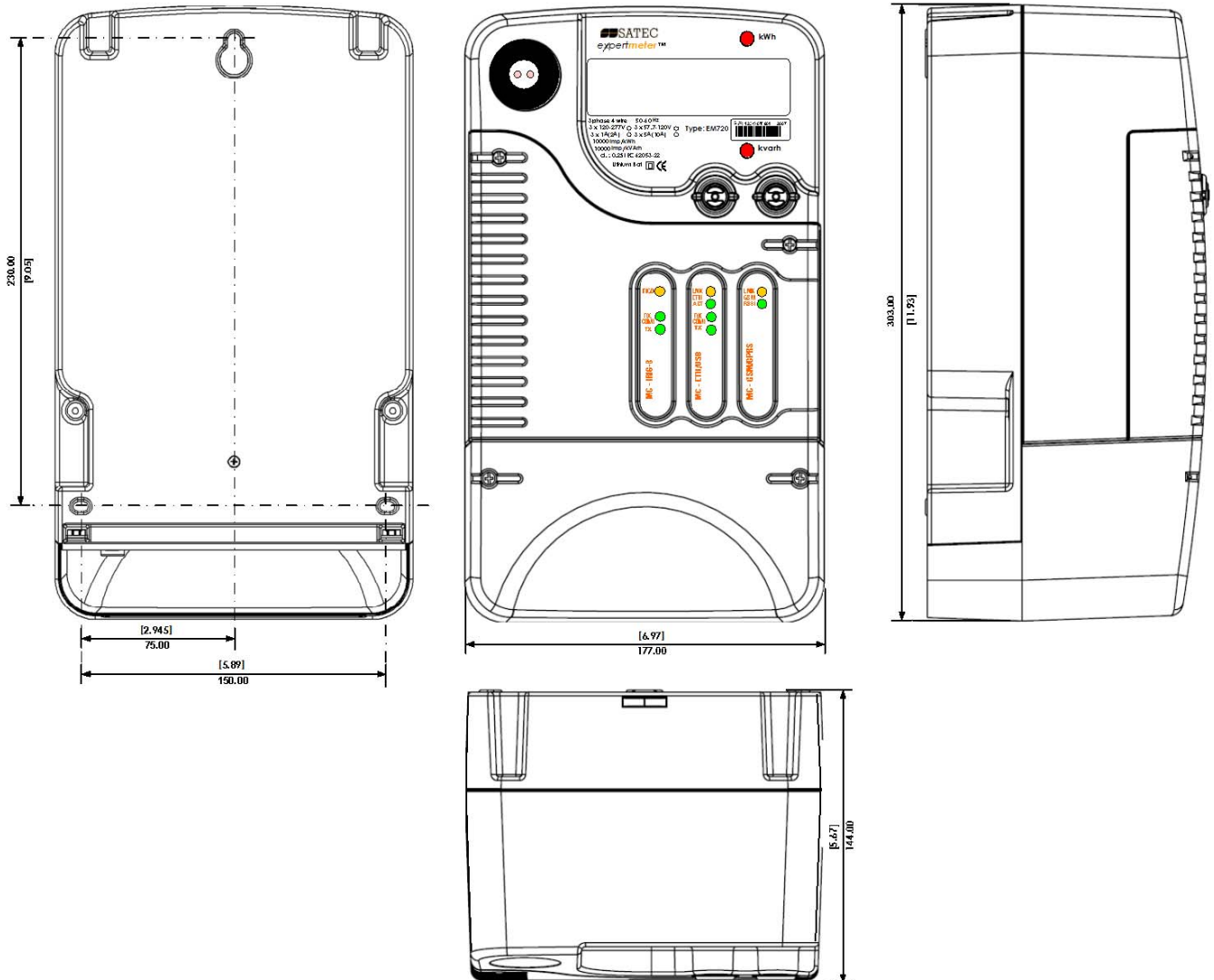
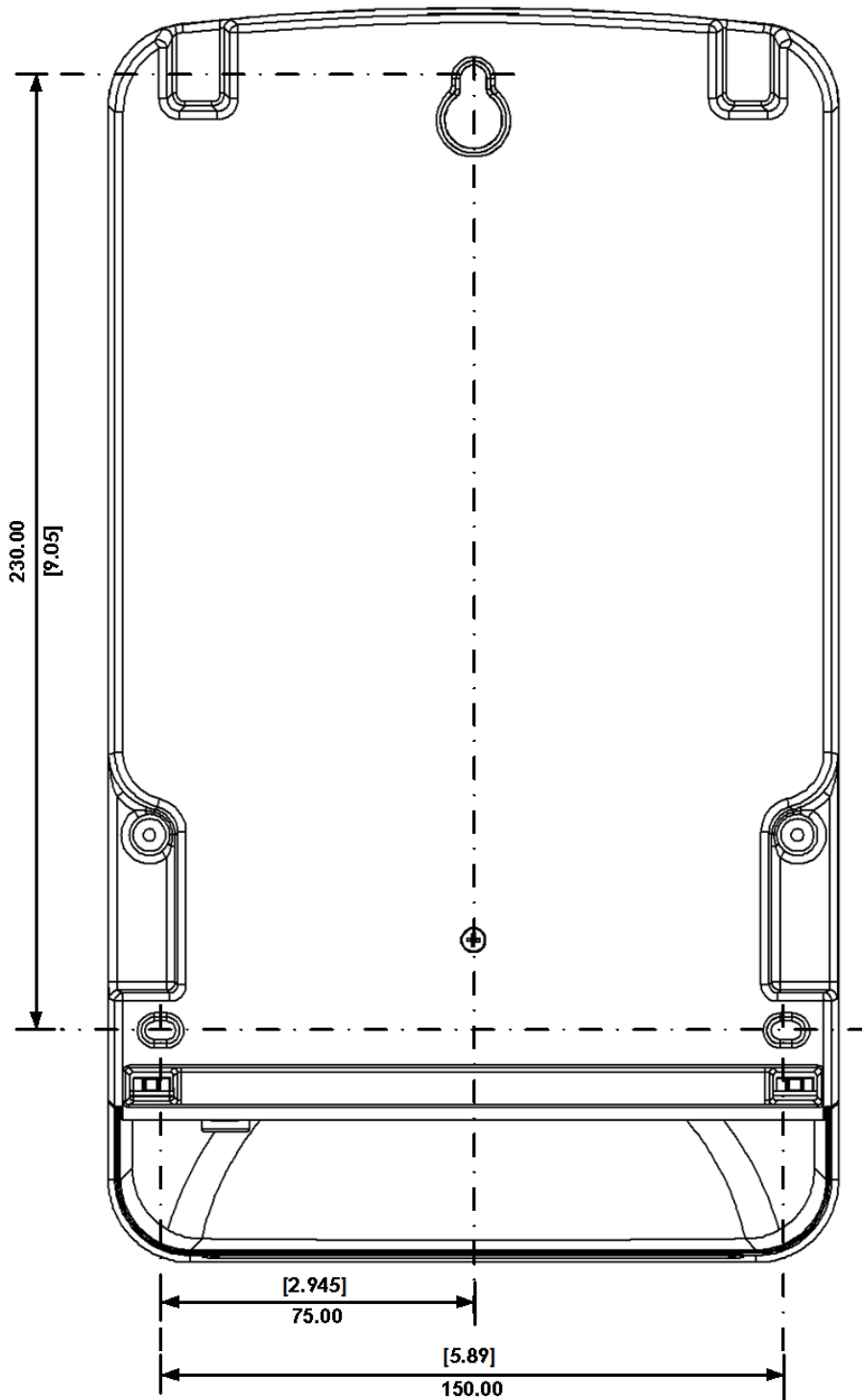

Figure 1: Dimensions



*Figure 2: Wall mount dimensions*



# Electrical Installation



Before installing, ensure that all incoming power sources are shut OFF. Failure to observe this practice can result in serious or even fatal injury and damage to equipment.

## Primary electrical installation

Before connecting the EM720 to the power measurement terminals, remove the EM720 front cover, then install the memory backup Lithium Battery backup (MBB) and Battery Pack Backup Power Supply (BPS)

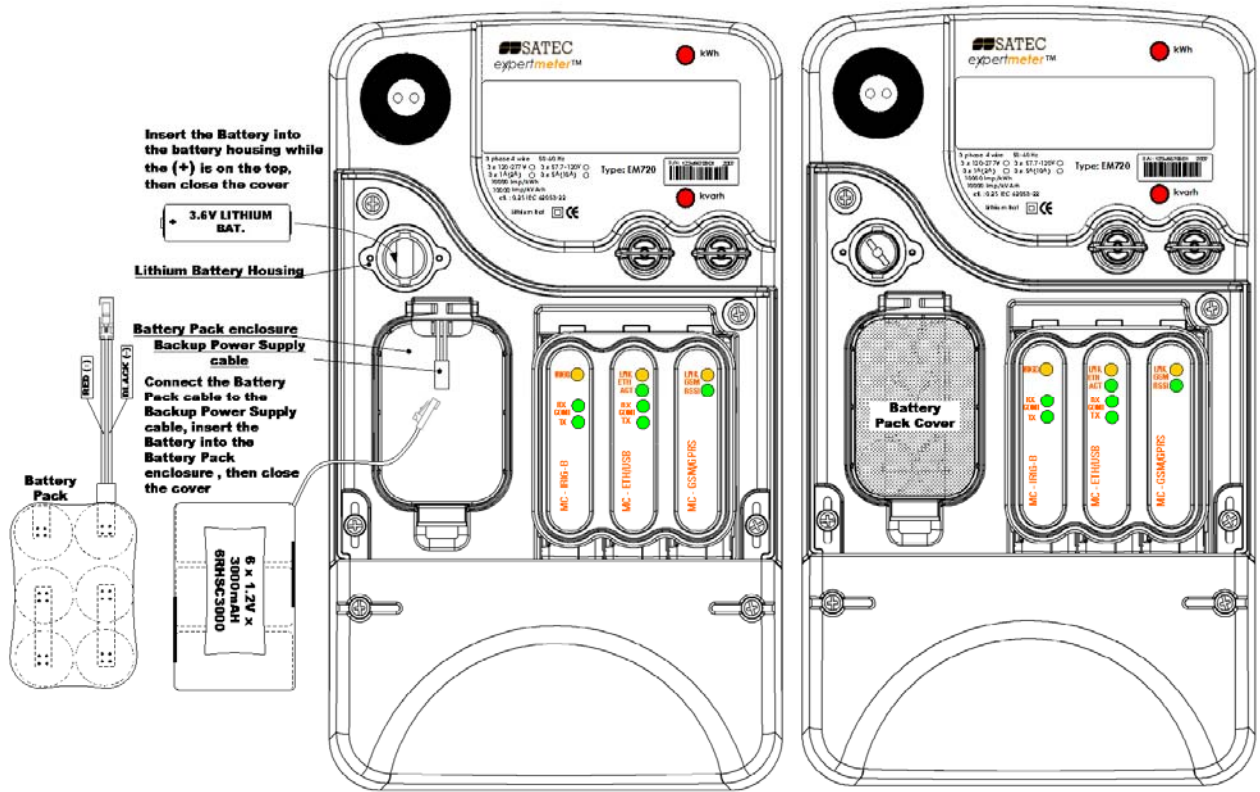

**Figure 3: Memory Backup Lithium Battery and Battery Pack Installation**



Before installing the instrument, ensure that the Battery Pack Backup Power Supply (BPS) is connected.

The BPS must be charged for a period of 16 consecutive hours before the installation.

Charging the BPS, connect the instrument to a three phase Power source, according to the instrument inputs rating, to the Voltage Inputs: make sure there are no plug-in modules.

## Voltage Inputs

There are 3 AC Y-connected voltage inputs of 480V (phase-to-phase) and neutral, via Main Terminal Block.

Copper wiring 2.5 - 6 mm<sup>2</sup> (10 AWG) should be used.

The EM720 Power Supply Inputs are the same as the Voltages Inputs

## Current Inputs

There are 4 current inputs up to 50A, connected to external CT's via Main Terminal Block.

Copper wiring 2.5 - 6 mm<sup>2</sup> (10 AWG) should be used.

## Signal Ground Input

For Transient measurements, connect Signal Ground (SG) Input to Ground via Main Terminal Block, if voltage neutral is isolated.

Copper wiring 2.5 - 6 mm<sup>2</sup> (10 AWG) should be used.

If voltage neutral is grounded, the Signal Ground Input should be connected to Voltage neutral Input

## Connectors location

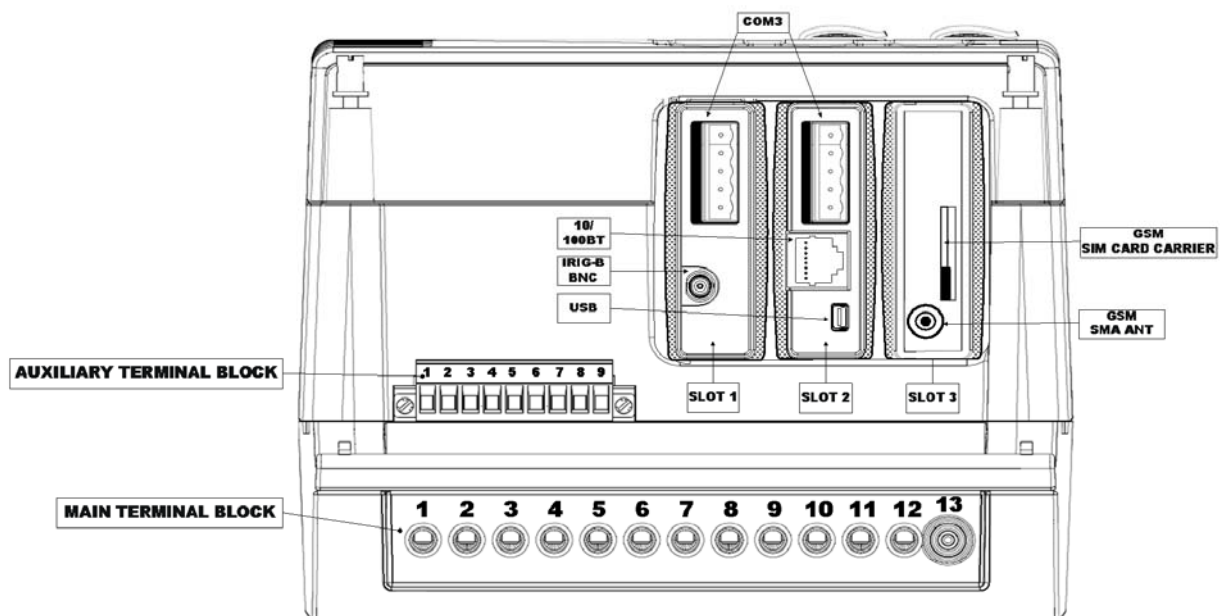

Figure 4: EM720 Connectors view

# Typical Installation

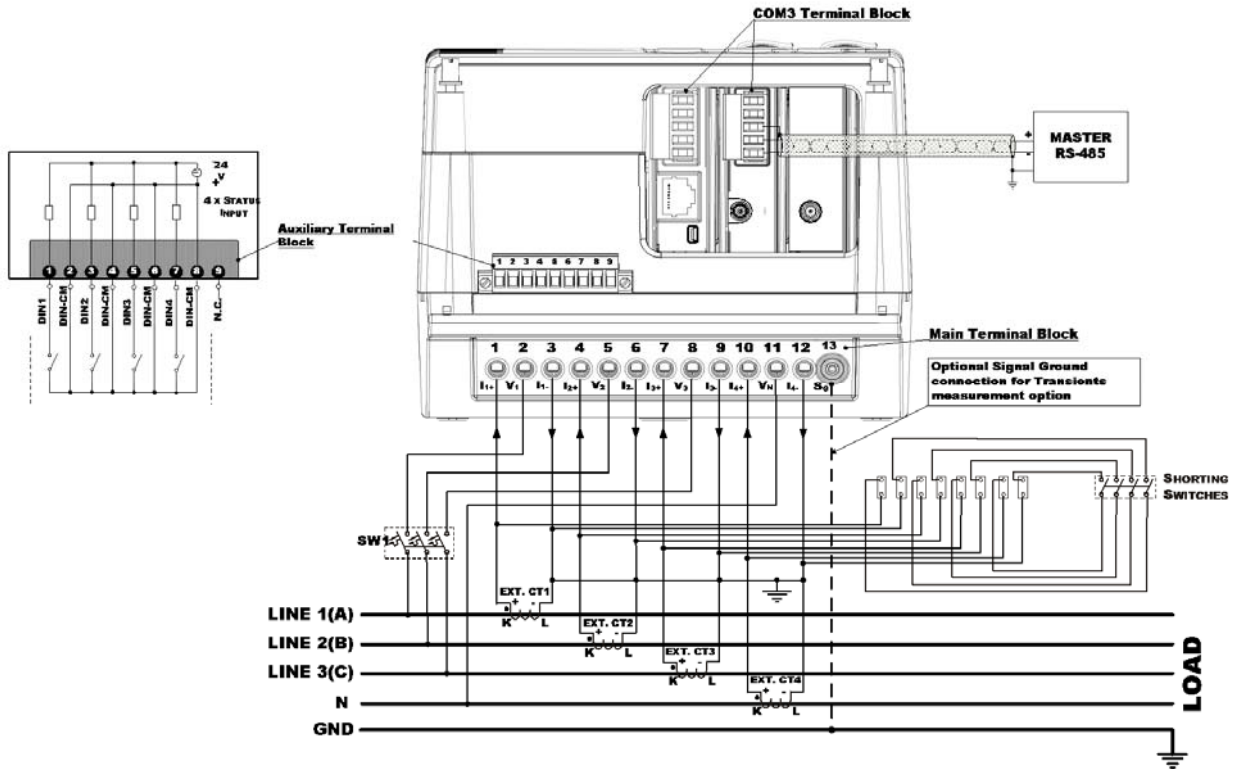

Figure 5: Typical Electrical Installation

## Wiring Configurations

There are seven wiring configurations shown in Figures 6, 7, 8, 9, 10, 11, 12 or 13;

Wiring Configuration	Wiring Setup	See Figure:
3-wire 2-element direct connection using 2 CTs	3dir2	<a href="#">6</a>
4-wire WYE 3-element using 3 (4) CTs	4Ln3 or 4LL3	<a href="#">7</a>
4-wire WYE 3-element connection using 3 PTs, 3 CTs	4Ln3 or 4LL3	<a href="#">8</a>
3-wire 2-element open delta connection using 2 PTs, 2 CTs	3OP2	<a href="#">9</a>
4-wire WYE 2½-element connection using 2 PTs, 3 CTs	3Ln3 or 3LL3	<a href="#">10</a>
3-wire 2½-element open delta connection using 2 PTs, 3 CTs	3OP3	<a href="#">11</a>
4-wire 3-element delta using 3 CTs	4Ln3 or 4LL3	<a href="#">12</a>

**Table 1: Wiring Configuration**

See parameter setup instructions in the Operation Manual

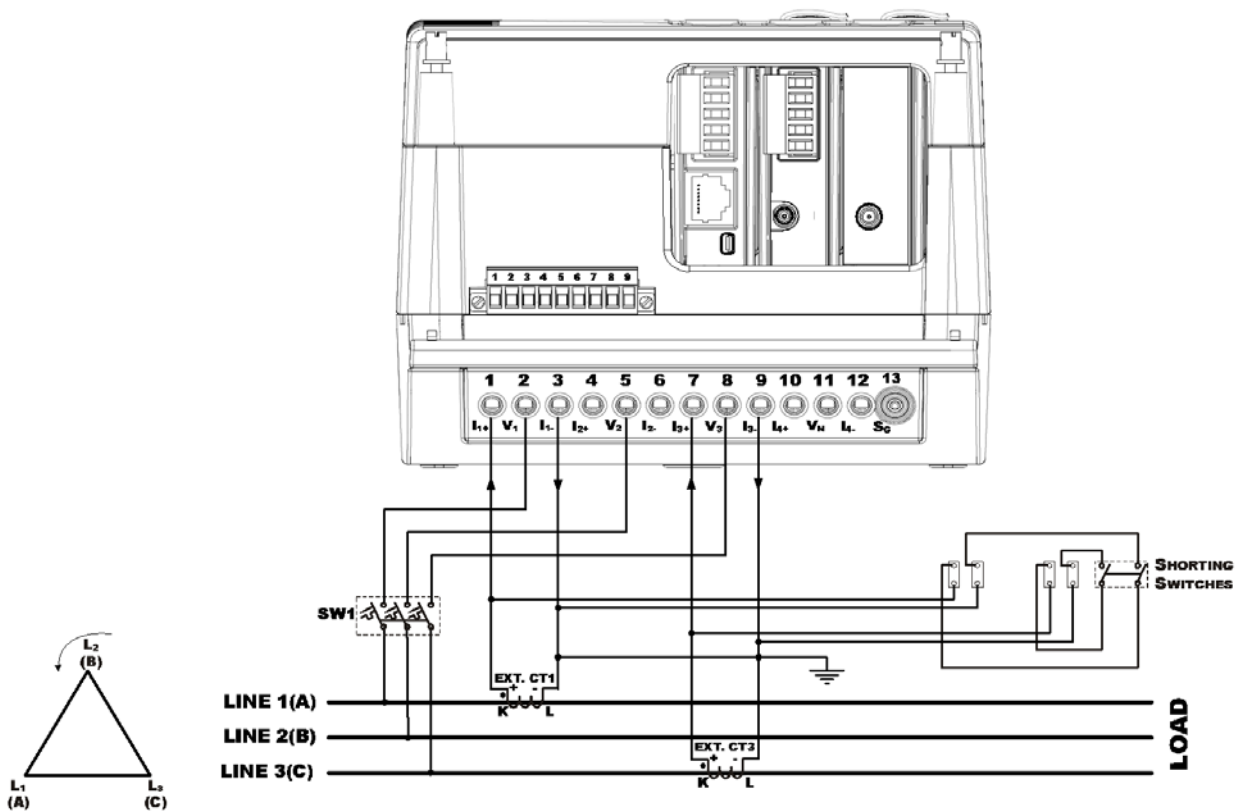

**Figure 6: Three Wire Using 2 CTs - Wiring Setup: 3dir2**

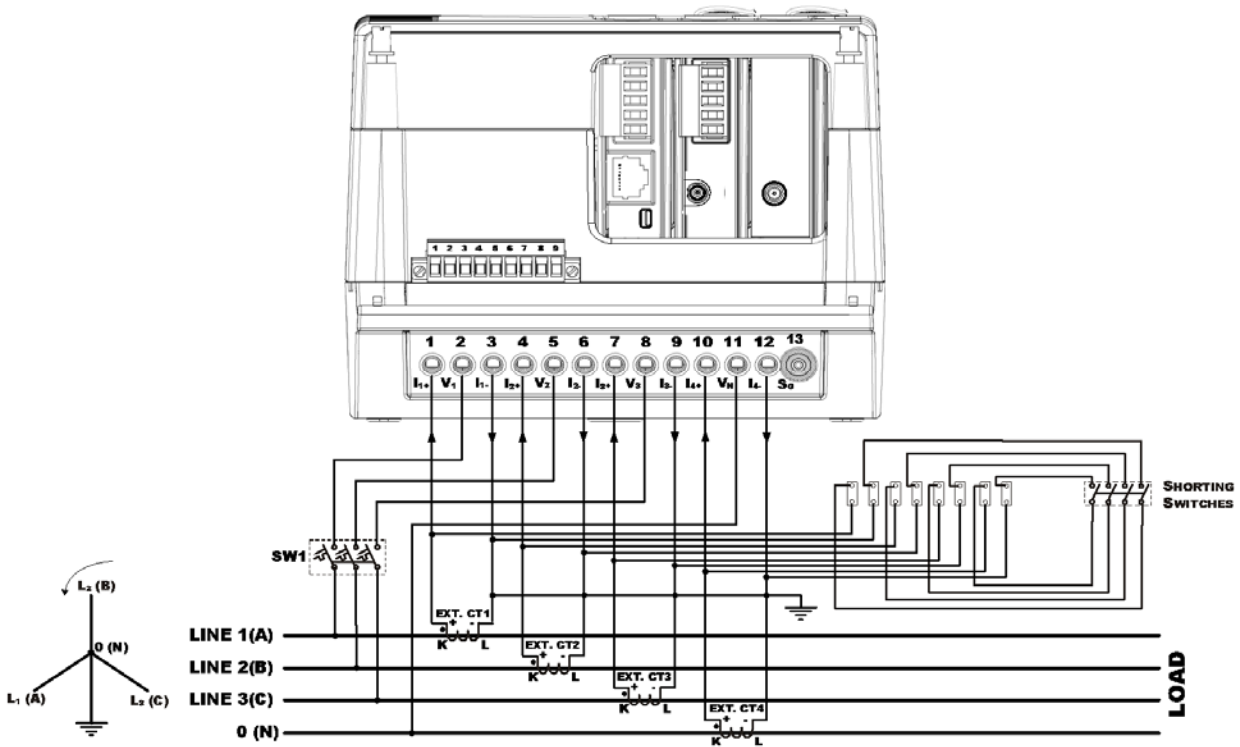

Figure 7: Four Wire WYE Connection Using 3(4) CTs - Wiring Setup: 4LL3 or 4Ln3

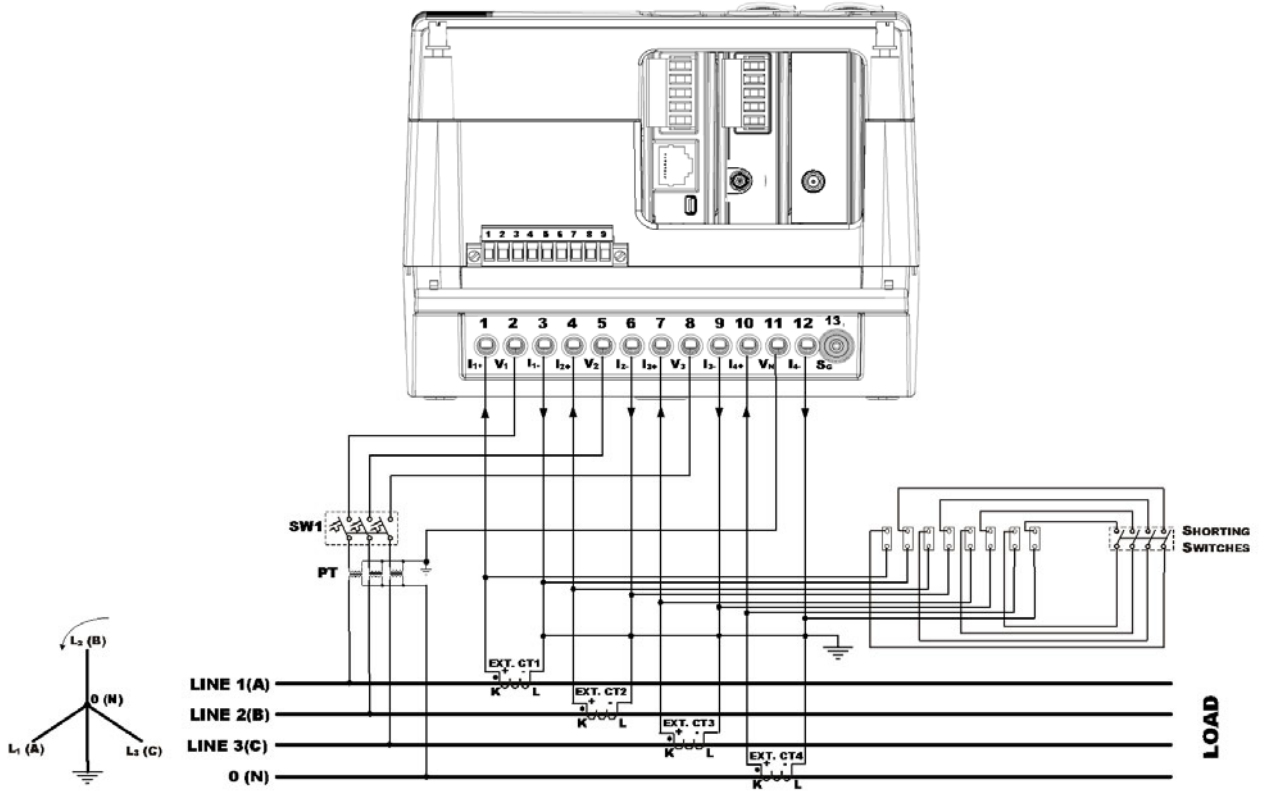

Figure 8: Four Wire WYE Connection Using 3 PTs, 3 (4) CTs - Wiring Setup: 4LL3 or 4Ln3

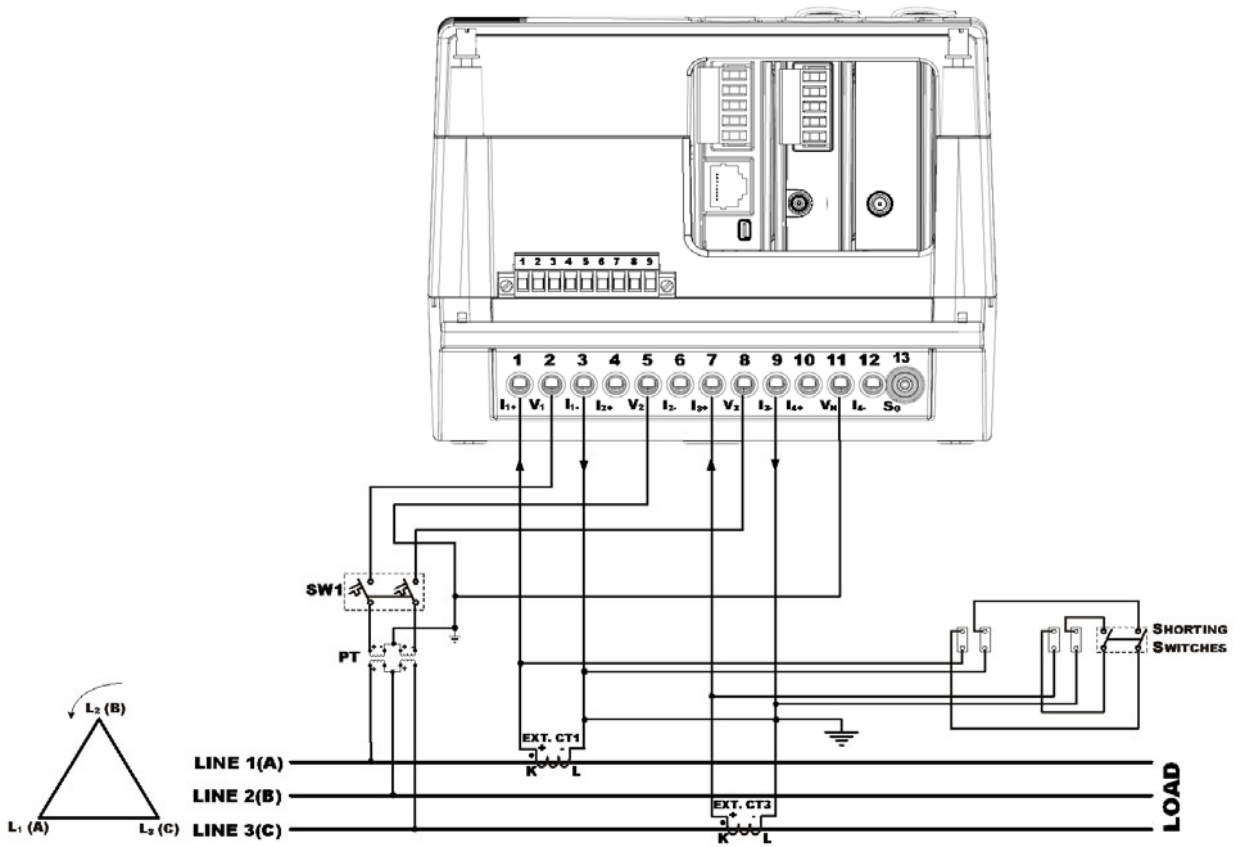

Figure 9: Three Wire Open Delta Connection Using 2 PTs, 2 CTs - Wiring Setup: 3OP2

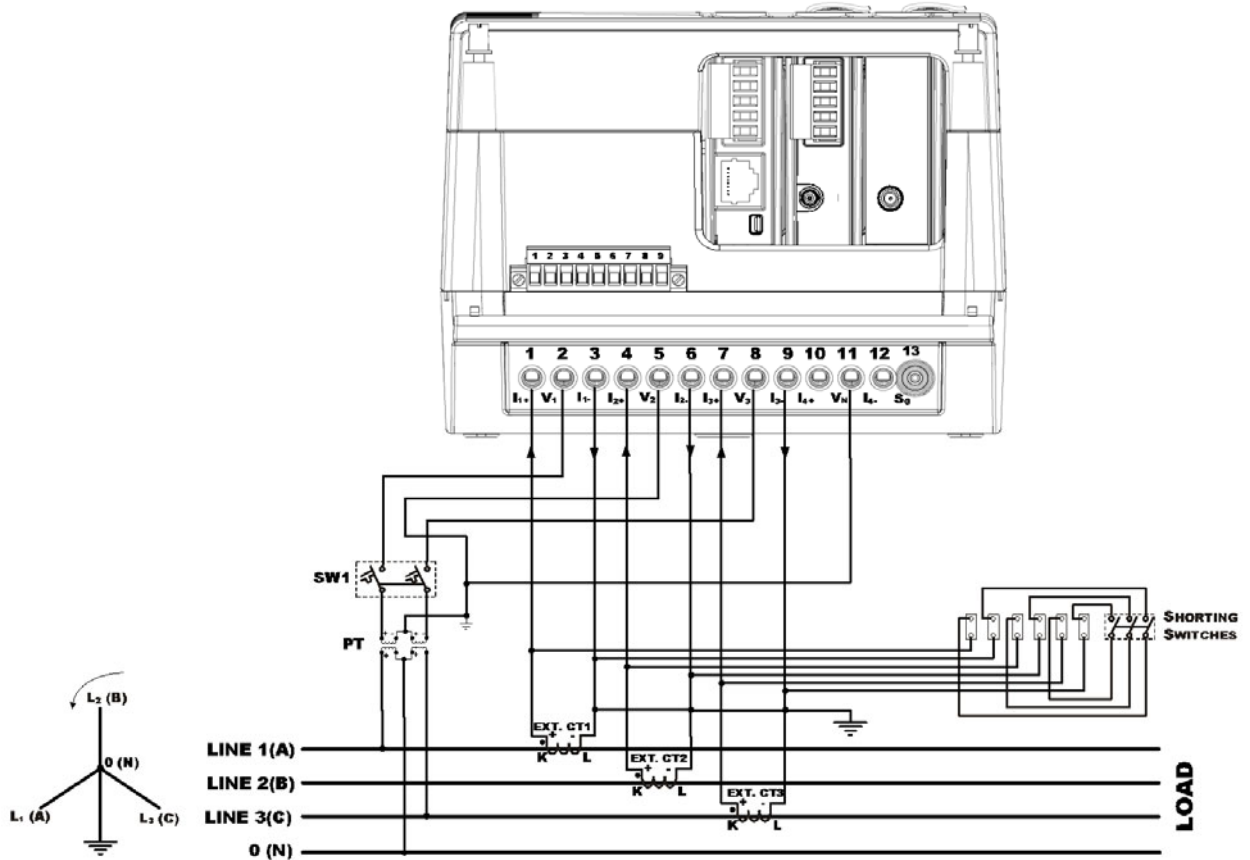

Figure 10: Three Wire Wye Connection Using 2 PTs, 3 CTs - Wiring Setup: 3LL3 or 3Ln3

Energy is measured with 2 CTs only - Phases 1(A) and 3(C)

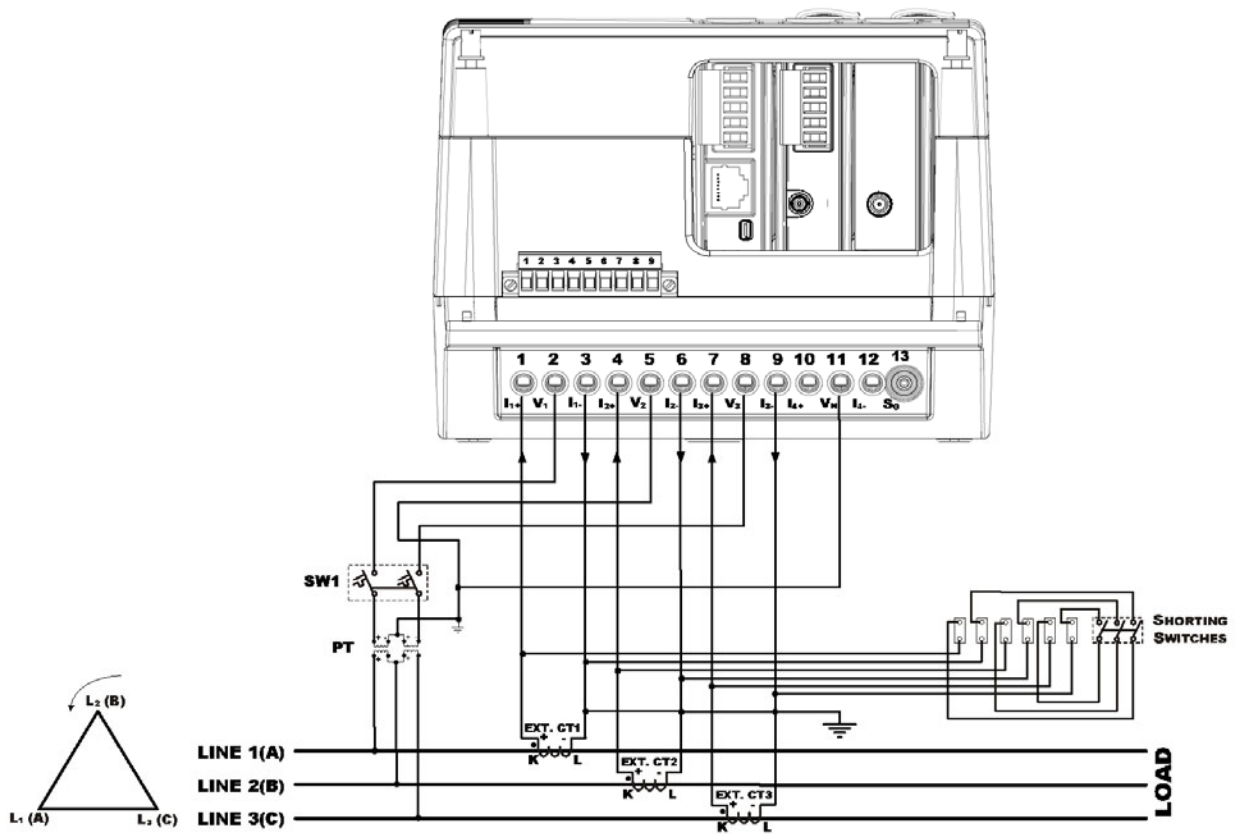

Figure 11: Three Wire Open Delta Connection Using 2 PTs, 3 CTs - Wiring Setup: 3OP3

Energy is measured with 2 CTs only - Phases 1(A) and 3(C)

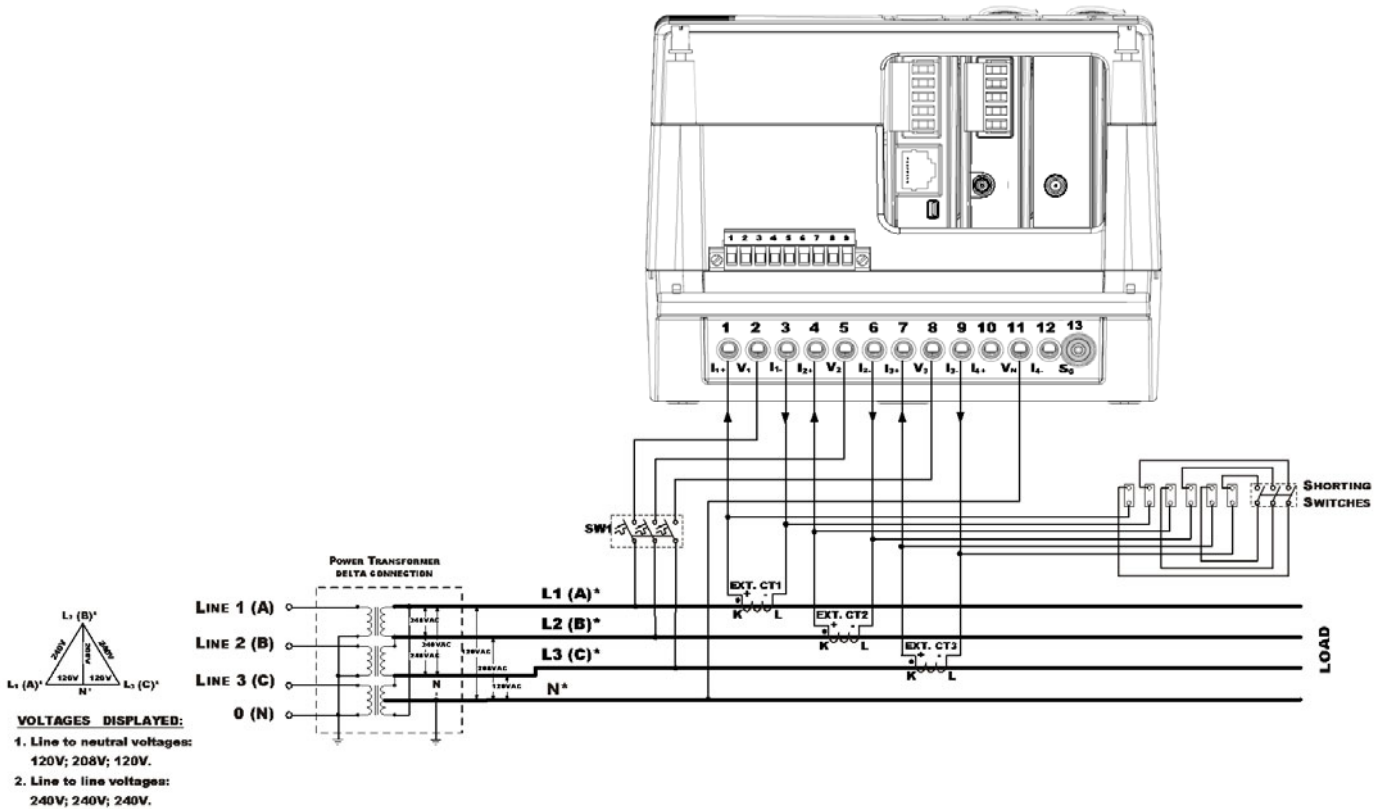

Figure 12: Four Wire Delta Connection Using 3 CTs - Wiring Setup: 4LL3 or 4Ln3

## Input / Output ports options

### On board Digital Inputs

The *EM720* is equipped with four fast Dry contact detector - Digital Inputs *4DI* unit.

The *4DI* unit is terminated with a nine-pin width pluggable terminal block which connects eight terminals only - Auxiliary Terminal Block as described below

TB PIN NUMBER	SIGNAL
1	DIN 1
2	COMMON
3	DIN 2
4	COMMON
5	DIN 3
6	COMMON
7	DIN 4
8	COMMON
9	NOT CONNECTED

**Table 2: Auxiliary Terminal Block**

Four optically isolated digital inputs are provided for status monitoring and external synchronization of power demand period and time. Dry contacts may be connected to these inputs, as shown in *Figures 14*. For ratings, see *Appendix: Technical Specifications*.

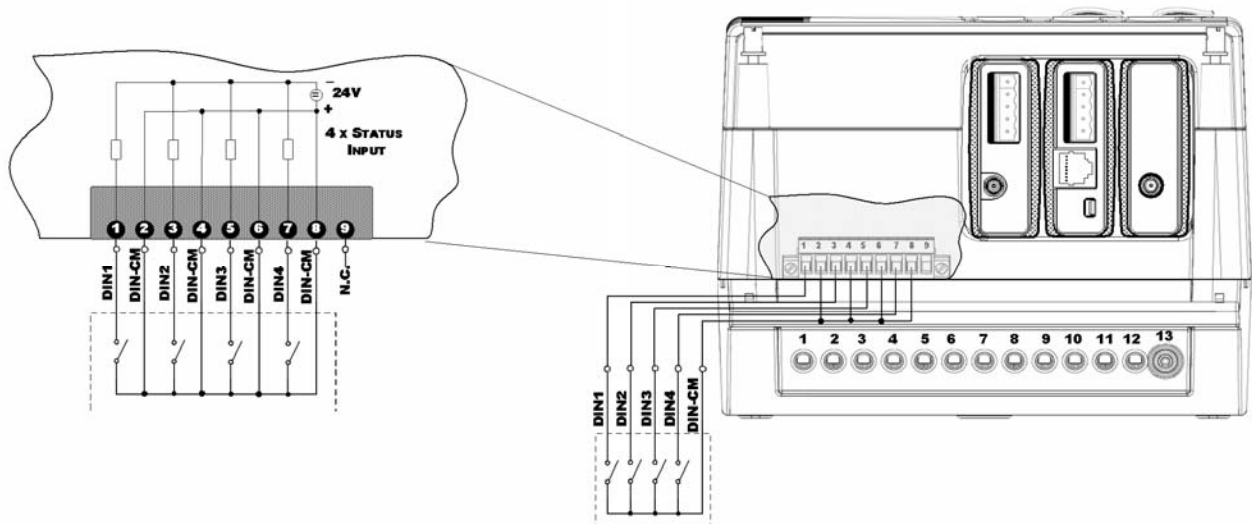

**Figure 13: Digital Input Connection**



### Digital Inputs/Digital Outputs (2DI/2DO - optional module)

The 2DI/2DO module consists of two status inputs and two FORM C relays outputs.

The 2DI/2DO module can be plugged-in any EM720 module slots

Two optically isolated digital inputs are provided for status monitoring dry contacts that may be connected to these inputs by a four pin detachable terminal block and two Change Over Relay Contacts are provided to a separate six pin detachable terminal block, as shown in *Figures 14*.

For ratings, see *Appendix: Technical Specifications*

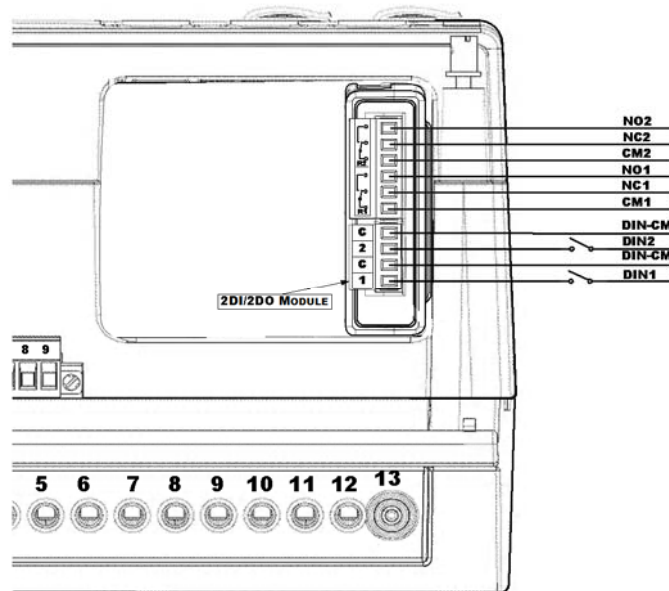

*Figure 14: 2DI/2DO Connection*

### Analog Inputs/Analog Outputs (4AI/4AO - optional module)

*Future*

## Communications options

The *EM720* has numerous communication possibilities depending on your ordering preferences. All communications ports, of different type, can be used simultaneously.

The *EM720* is equipped with one standard optical communication (COM) port. Other COM ports are available as optional module.

### Infrared Communication port (COM1)

Mount an optical probe cable (not included), at the instrument front panel, to communicate between the meter optical port and a PC serial port

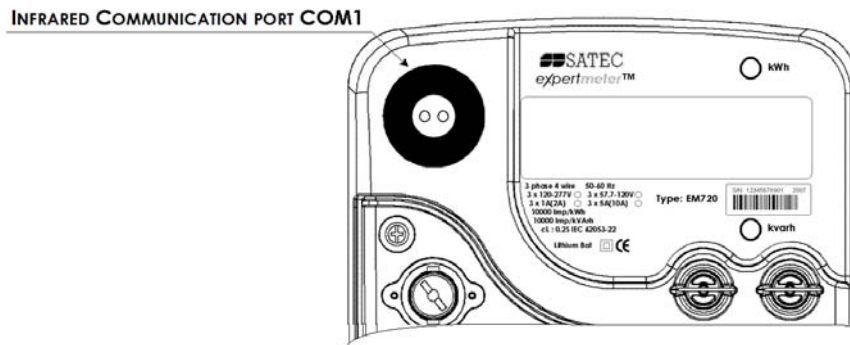

*Figure 15: Infrared Communication port - COM1*

### Wireless Communication port - GSM/GPRS module (COM2 - optional module)

The Wireless Communication port - COM2 is provided by optional module: GSM/GPRS module.

The *GSM/GPRS* module can only be plugged-in the *EM720* module slot 3.

The Before plugging-in the GSM/GPRS module to the instrument, insert the SIM card into the SIM card carrier, then pull the slide to lock the SIM card as shown in figure 16.

1. Push down the SIM carrier slide
2. Insert the SIM card into SIM carrier
3. Push up the SIM carrier slide to lock the SIM card
4. Plug-in the GSM/GPRS module into the instrument at slot 3

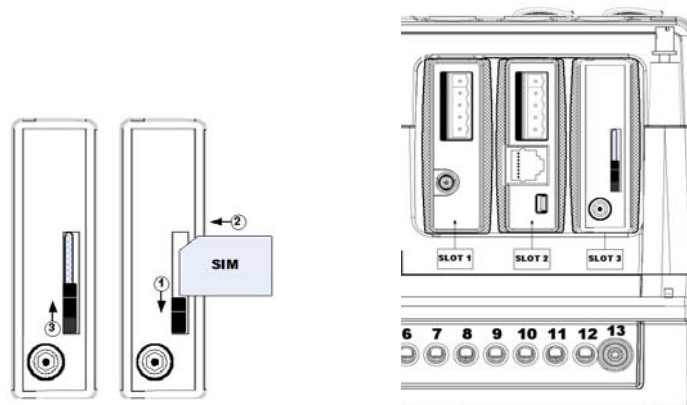

*Figure 16: GSM/GPRS Communication port - COM2*

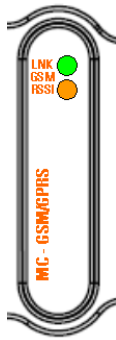

5. After one minute the "LNK" GREEN LED is flashing until it lights "ON" continuously
6. The "RSSI" ORANGE LED will light "ON" or blinks, the flashing rate is proportional to the RF receive level (RSSI), if RF receive level is high then the led is "ON" continuously, if RF receive level is poor then the led is blinking

### RS-485/232 Communication port (COM3 - optional module)

The RS-485/232 Communication port - COM3 is provided by optional modules: IRIG-B and ETH/USB modules.

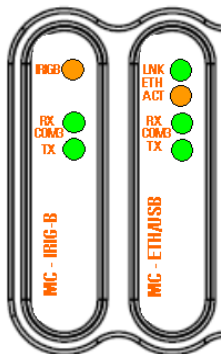

Each module with Communication port - COM3, provides two indication GREEN LEDES:  
 "RX" GREEN LED, blinking led shows receiving data at COM3  
 "TX" GREEN LED, blinking led shows sending data at COM3

While mounting IRIG-B and ETH/USB modules in the same instrument, only one RS-485/232 Communication port can be active (COM3).

### RS-485 mode

In the RS-485 mode, the 485/232 terminal of the 5 pin plug-in terminal block should be remain open as shown in figure 16

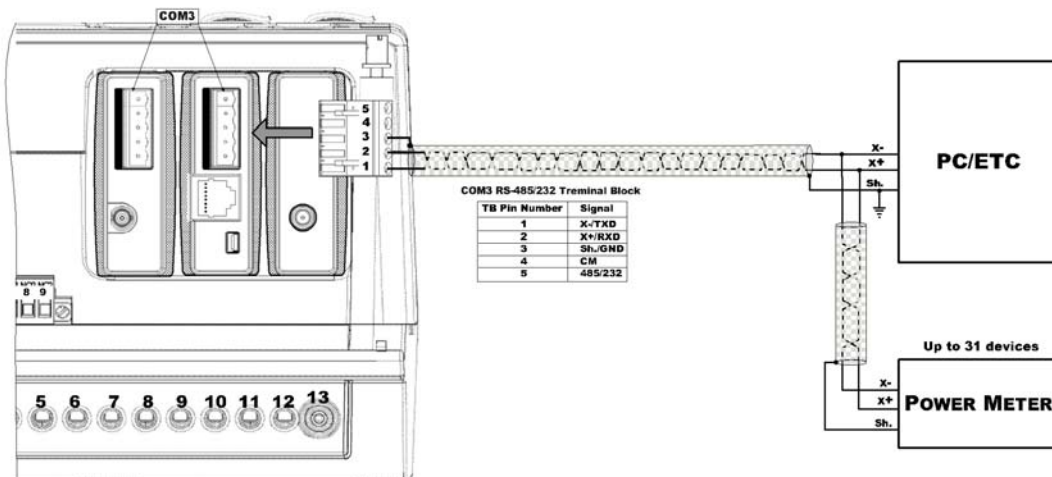

Figure 17: Serial Communication Network Connection - RS-485 COM3

### RS-232 mode

In the RS-232 mode, the 485/232 terminal of the 5 pin plug-in terminal block should be connected to CM as shown in figure 17

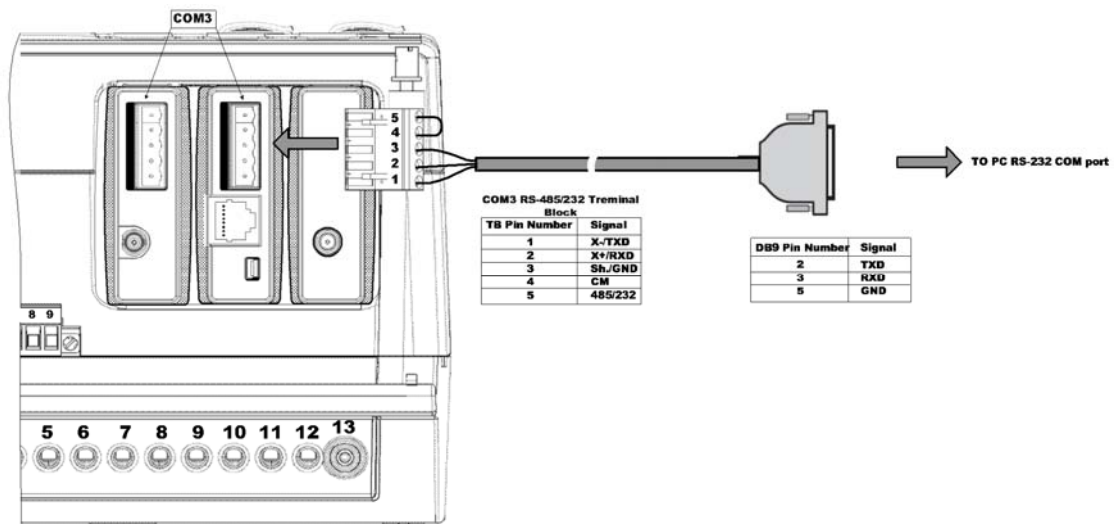
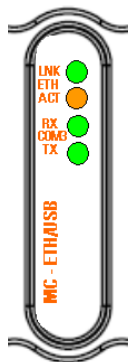

Figure 18: Serial Communication Connection - RS-232 COM3

### ETHERNET/USB Communication port (ETH/USB - optional module)

The *ETH/USB* module provides a standard 10/100 BT Ethernet and full speed mini-USB device ports, terminated with RJ45 connector for ETHERNET and mini-USB type B connector for Laptop USB port, as shown in figure 18 and figure 19, respectively.

The *ETH/USB* module can only be plugged-in the *EM720* module slots 1 and 2.



The *ETH/USB* module provides additionally to COM3 indication GREEN LEDs, ETHERNET indication leds :  
 "LNK" GREEN LED/ "ACT" ORANGE LED, when "LNK" is "ON" continuously and "ACT" is blinking, it shows that the ETHERNET is active



Figure 19: 10/100BT Ethernet RJ45 Connection

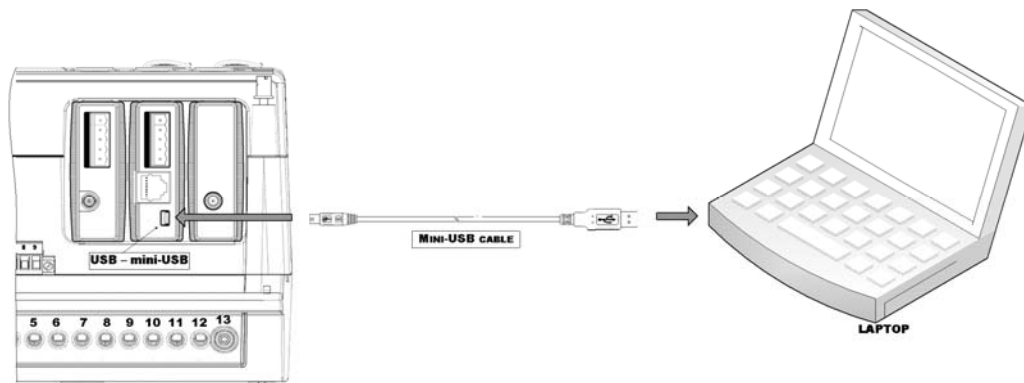

*Figure 20: Mini-USB device Connection*



To prevent potential differences between the Personal Computer (PC) USB port and the EM720 USB device port, it is recommended to use a galvanic isolated USB adaptor before connecting the EM720 USB port to a Personal Computer (PC), or to use battery powered PC.

## Auxiliary Power Supply

### Low DC Auxiliary Power Supply

The *EM720* can be equipped with additional power supply to redundant the built-in power supply (Auxiliary Power Supply - *APS*), without need of Battery backup Power Supply (*BPS*).

The DC *APS* can be plugged-in any *EM720* module slots.

The *APS* module is connected to an external DC Voltage source with a three-pin width pluggable terminal block, as shown in figure 20, see [Technical Specification](#) for DC Voltage Inputs requirements

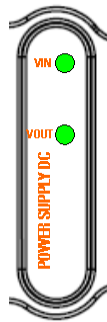

The DC *APS* module provide two indication GREEN LEDS:

"VIN" GREEN LED: is "ON" continuously when DC voltage is applied to the terminals

"VOUT" GREEN LED: is "OFF" if Measurement AC Voltages inputs are applied to the *EM720*  
is "ON" if Measurement AC Voltages inputs are missing

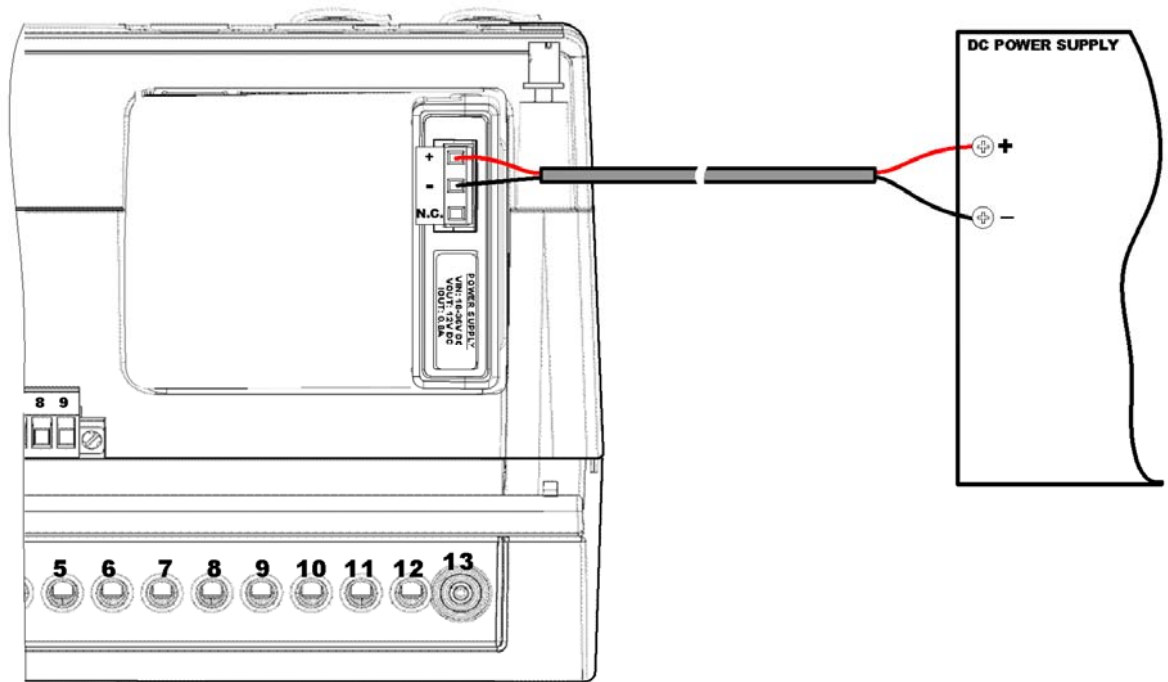

Figure 21: Auxiliary DC Power Supply Connection

## Location of Modules

The 3 slots expand the *EM720* with additional input/output ports (future module), communication modules and Auxiliary DC Power Supply module.

The following functions are available in the following slots:

- IRIG-B - any slot
- COM2 (Dial up or Cellular modem port) - slot 3 only
- COM3 - any slot
- Ethernet - any slots
- USB - slots 1 and 2
- I/O (future) - any slot
- AUX. POWER SUPPLY - any slot

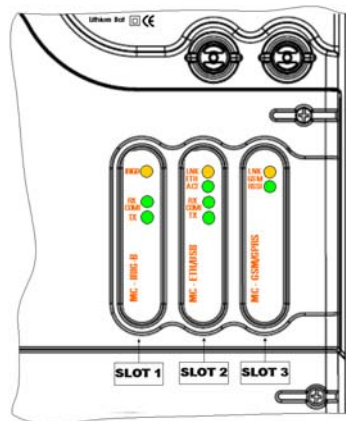

*Figure 22: Modules Front panel side*

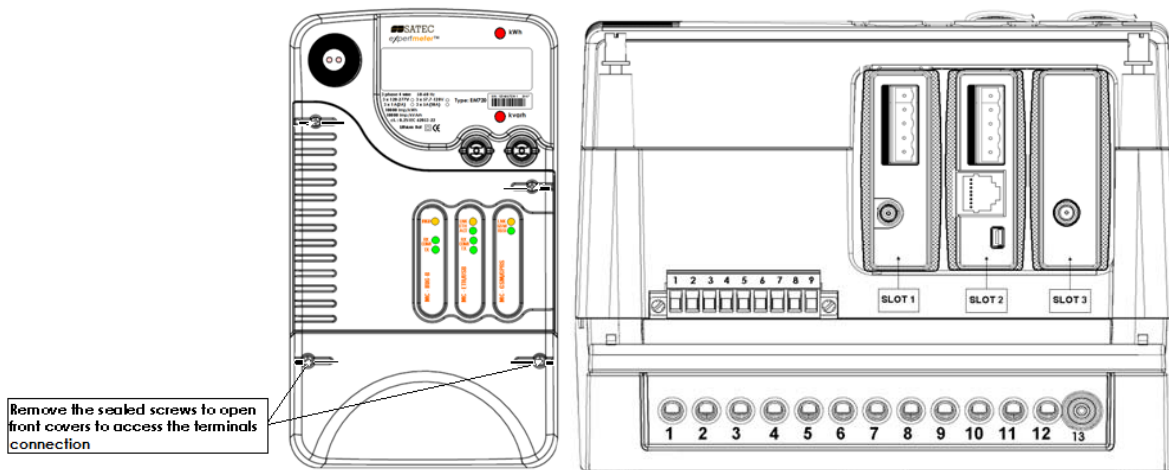

*Figure 23: Modules connectors side*

# Chapter 3 Communications

## Computer Connections - RS-232

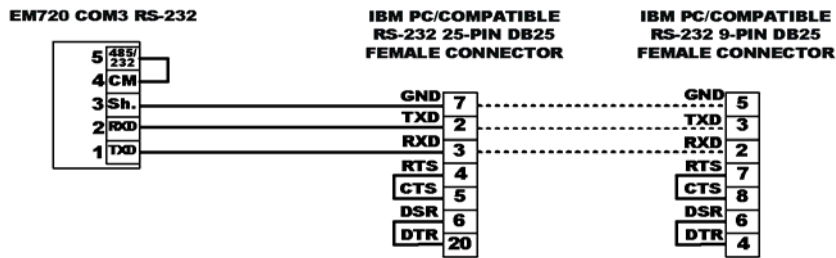

Figure 24: RS-232 Simple 3-wire Connection , 25-pin or 9-pin PC COM Port

## Computer Connections - RS-485

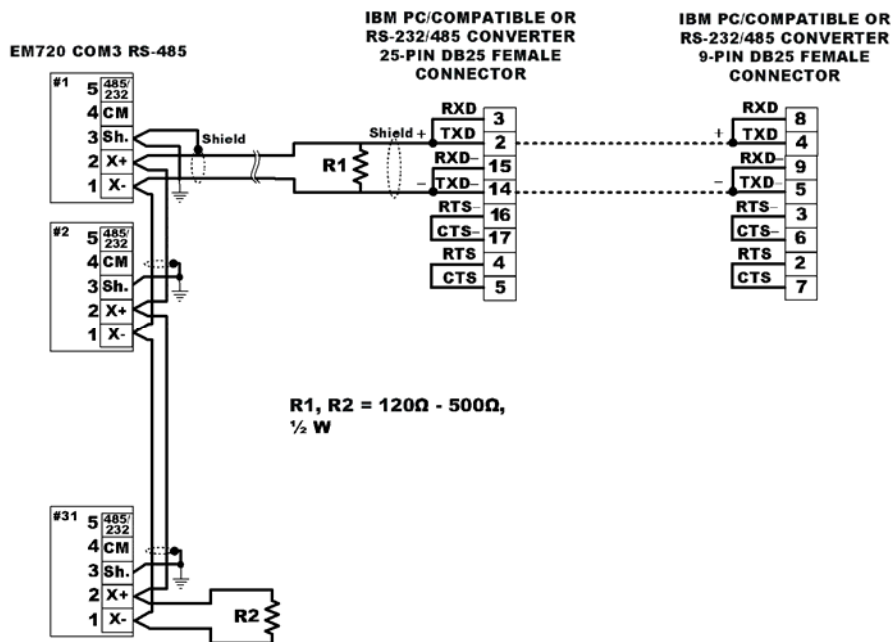



Figure 25: RS-485 Multidrop Connection, 25-pin or 9-pin PC COM Port



# Chapter 4 Replacing the Battery

When the battery level drops below the minimum allowed threshold, the LCD graphic display, on the front of the device, shows: , indicating that the battery should be replaced. Use the following procedure:

1. Remove the sealed screws to open the front covers, as in figure 24

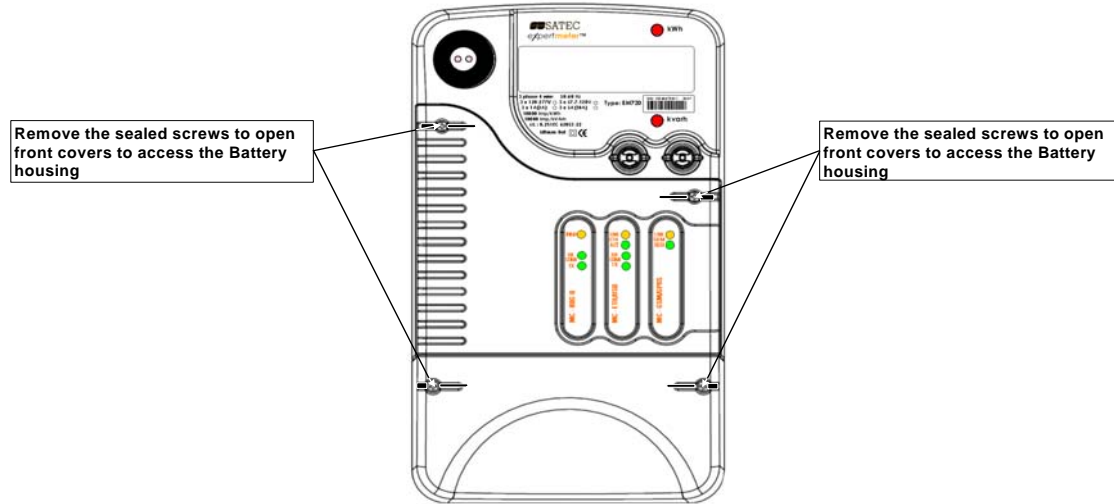

**Figure 26: Front covers removing**

2. Use a flat screwdriver to open the battery housing cover, as in figure 25, turning counter-clockwise and remove the battery,

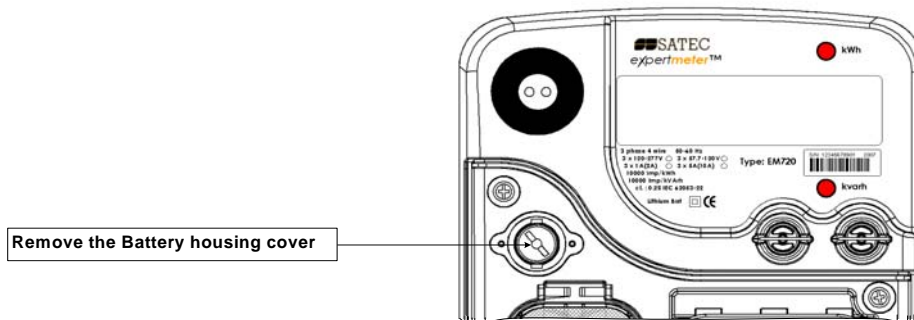

**Figure 27: Battery Housing cover removing**

3. Replace the battery - with the plus towards the outside, as in figure 26, and close the battery housing

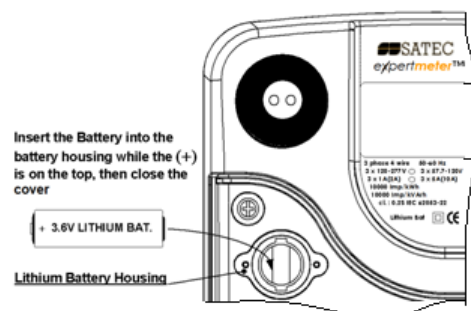

**Figure 28: Replacing the 3.6V Lithium Battery**

## IMPORTANT

- Use an AA lithium 3.6 volts battery.
- In order not to lose data stored in the memory, use PAS to upload data (see EM720 Operation Manual, Chapter 12) to a PC BEFORE changing the battery; OR, make sure you replace the battery while the power is ON. If you replace the battery while power is off, you will lose all data currently stored in the memory.

# Appendix: Technical Specifications

## Inputs Ratings

<b>AC Voltage inputs</b>	V1, V2, V3, VN and VG	50/60 Hz
Reference voltage $U_n$ 57.73V up to 120V L-N (via PT)	Voltage rating: 3 x 57.73/100 V 3 x 63/110 V 3 x 69/120 V 3 x 57.73 V 3 x 63 V 3 x 69 V	
	Voltage range,	0 up to 144 V
	Crest factor	$\geq 2$ (voltage peak up to 300V)
	Temporary over voltage between live conductors and earth	240 V r.m.s
	Transient over voltage between live conductors and earth (from 15 $\mu$ s up to milliseconds)	2 kV peak
	Starting voltage	0.5% $U_n$
	Burden per phase	< 0.2 VA
	Overload withstand for 1 minute phase-to-ground (IEC 62053-22, protective class II)	4000V r.m.s
	Rated impulse voltage (IEC 62052-11, protective class II)	6000V
	Terminals for wires size	2.5 up to 6 mm <sup>2</sup>
Reference voltage $U_n$ 120V up to 277V L-N	Voltage rating: 3 x 120/207 V 3 x 220/380 V 3 x 230/400 V 3 x 277/480 V 3 x 220 V 3 x 230 V 3 x 277 V	
	Line to Neutral voltage range	0 up to 320 V r.m.s,
	Crest factor	$\geq 2$ (voltage peak up to 700 V)
	Temporary over voltage between live conductors and earth	1.0 kV r.m.s
	Transient over voltage between live conductors and earth (from 15 microseconds up to milliseconds)	2kV
	Starting voltage	0.5% $U_n$
	Burden per phase	< 0.5 VA
	Overload withstand for 1 minute phase-to-ground (IEC 62053-22, protective class II)	4000V r.m.s
	Rated impulse voltage (IEC 62052-11, protective class II)	6000V peak
	Terminals for wires size	2.5 to 6 mm <sup>2</sup>

**AC Current inputs****4 Galvanic isolated Inputs**

Reference Current	Overload current (continuously) $I_{max}$	$2 \times I_n$
Basic model $I_n = 5A$	Maximum measurable short circuit current ( $I_{sc}$ )	$10 \times I_n$
Option model $I_n = 1A$	Burden per phase ( $I_n = 5 A$ )	$< 0.2 VA$
	Burden per phase ( $I_n = 1 A$ )	$< 0.05 VA$
	Starting current (I1, I2, I3)	$0.1\% I_n$
	Starting current (I4)	$0.5\% I_n$
	Over current withstand for 1 second non-recurring	$50 \times I_n$
	Voltage galvanic isolation rating	4000V r.m.s
	Terminals for wires size	2.5 to 6 mm <sup>2</sup>

# Power Supply

## 3P power supply (MPS)

207-480V AC 50/60 Hz  
100-120 V AC 50/60 Hz

## Power Supply Inputs from measured AC Voltage inputs

High range power supply (480V option) 96- 575V AC  
Low range power supply (120V option) 45 - 250 V AC

Burden as per IEC 62053-61 multi-function meter requirements 3 W and <15VA/phase

## Battery backup Power Supply (BPS)

Build-in rechargeable NiMh battery, Redundant MPS 2.5 hours backup

## AUX. Power Supply (APS)

Low DC Power Supply, Redundant MPS

DC PS module -  
Optional

DC input 24V DC  $\pm$  15%

Power Consumption 6W maximum  
Dielectric insulation withstand 4 KVAC @ 1mn  
Terminals for wires size 2 x 4 mm<sup>2</sup>

## Real Time Clock Battery backup

According to IEC 61038 > 3 consecutive years  
Field replaceable Lithium battery More than 10 years service battery life

# Input/Output ports

## Digital Input Basic

Dry contact - Optically isolated  
Wetting (internally) input contact

4 inputs  
24 VDC internal power supply  
(5mA wetting current per contact)  
> 1M $\Omega$   
< 100 $\Omega$   
1ms  
4 KVAC @ 1mn  
8 x 2.5 mm<sup>2</sup>

## Digital Input 2DI/2DO module - Optional

Dry contact - Optically isolated  
Wetting (internally) input contact

2 inputs  
24 VDC internal power supply  
(5mA wetting current per contact)  
> 1M $\Omega$   
< 100 $\Omega$   
1/2 cycle (50/60 Hz)  
4 KVAC @ 1mn  
4 x 2.5 mm<sup>2</sup>

## Solid State outputs 2DI/2DO module - Optional

SSR FORM C  
Maximum switching voltage  
Make and carry capacity  
Maximum operate time  
Maximum release time  
Dielectric insulation withstand  
Terminals for wires size

2 relays  
250VAC/VDC  
0.12A max  
1 ms  
1 ms  
4 KVAC @ 1mn  
6 x 2.5 mm<sup>2</sup>

## Relay outputs 2DI/2DO module - Optional

Electromechanic FORM C  
Maximum switching voltage  
Make and carry capacity  
Maximum operate time  
Maximum release time  
Dielectric insulation withstand  
Terminals for wires size

2 relays  
250VAC/110VDC  
10A max  
7 ms  
5 ms  
4 KVAC @ 1mn  
6 x 2.5 mm<sup>2</sup>

# Communication ports

<p><b>COM1</b> IR - Basic</p>	<p>Front panel Optical Communication port Max. Baud rate Protocols</p>	<p>IEC 62056-21 19.200 kb/s Modbus RTU/ASCII and DNP3.0</p>
<p><b>COM2</b> GSM/GPRS module - Optional</p>	<p>Plug-in modules isolated communication port GSM/GPRS module Max. Baud rate Protocols  Isolation GSM/GPRS module antenna connector</p>	<p>Field installable Quad Band GPRS class10 115.2 kb/s Modbus RTU/TCP and DNP3.0/TCP 4 KVAC @ 1mn SMA</p>
<p><b>COM3</b> IRIG-B module - Optional ETHERNET/USB module -</p>	<p>Plug-in modules isolated communication port Versatile RS232/RS485 Max. Baud rate Isolation Protocols  Terminals for wires size</p>	<p>Field installable  115.2 kb/s 4 KVAC @ 1mn Modbus RTU/ASCII and DNP3.0 5 x 2.5 mm<sup>2</sup></p>
<p><b>IRIG-B</b> IRIG-B module - Optional</p>	<p>Isolation Time code signal  Signal Level Connector Type Recommended cable  Recommended GPS time code generator</p>	<p>4 KVAC @ 1mn Unmodulated (pulse-width coded) Unbalanced 5V BNC 51Ohm low loss - RG58A/U (Belden 8219 or equivalent), TNC connector Masterclock GPS-200A</p>
<p><b>10/100 Base T</b> ETHERNET/USB module - Optional</p>	<p>Plug-in modules network communication port Wired LAN communication port Ethernet port Baud rate  Protocols  ETH port Isolation ETH connector</p>	<p>Field installable IEEE 802.3 10/100 Mb/s, auto-negotiation Modbus/TCP or DNP3.0/TCP protocols, up to five non-intrusive simultaneous connections, Telnet service port 3 KVAC @ 1mn Standard RJ-45</p>
<p><b>USB</b> ETHERNET/USB module - Optional</p>	<p>Plug-in modules network communication port USB communication port USB port Baud rate USB port Isolation Protocols  USB connector</p>	<p>Field installable Full speed Device 12 Mb/s 1.5 KVAC @ 1mn Modbus RTU/ASCII and DNP3.0 Mini-USB type B</p>

## Console Display Unit

<b>Display</b>	LCD graphic bright display	Multiple screens display
	Resolution	128 x 32 dots
	Viewing area	99.0 x 24.0 mm
	Operational temperature	-20°C to + 70°C
	Backlit LCD display screen	Timeout operation
<b>LEDs</b>	Active and reactive energy led pulses	2
<b>SCROLL</b>	Monitoring and configuring Sealed buttons	2
<b>SELECT/ENTER buttons</b>		
<b>IR port</b>	Infra red communication port	COM1

## Real Time Clock

5 ppm Accuracy @ 25°C	2.7 minute / year
RTC backup data retention	5 years

## Log Memory

Non Volatile Memory	Standard Log Memory	8MBytes
(20years Data retention)	Expanded Log Memory	16MBytes

## Environmental Conditions

Full Accuracy Operational temperature	-25°C to + 60°C
Operational temperature	-40°C to + 70°C
Storage temperature	-45°C to + 85°C
Humidity	0 to 95% non-condensing

## Construction

<b>Enclosure</b>	Reinforced Plastic material and corrosion resistant	Flammability UL94V0
With sealing cover	Size: 303mm(L) x 177mm (H) x 144mm (D)	
	Weight (including NiMH battery)	3.95 kg
	Mounting	DIN43857

# Standards Compliance

<b>EMC</b>	IEC standards	IEC 61000-2
Immunity	ESD - IEC61000-4-2/IEC 62052-11	15KV/- air/contact
	Electromagnetic RF Fields - IEC61000-4-3/IEC 62052-11	30V/m @ 80Mhz - 1000MHz
	FTB - IEC61000-4-4/IEC 62052-11	4KV on current and voltage circuits and 2 KV for auxiliary circuits
	SURGE - IEC61000-4-5/IEC 62052-11	4KV on current and voltage circuits and 1 KV for auxiliary circuits
	Conducted Radio-frequency - IEC61000-4-6/IEC 62052-11	10V @ 0.15Mhz - 80MHz
	Power Frequency Magnetic Fields - IEC61000-4-8	
	Damped oscillatory waves - IEC61000-4-12/IEC 62052-11	CMM 2.5KV and DFM 1KV @ 100KHz and 1MHz
Emission	Radiated / Conducted	
	CISPER 22	Class A
<b>Safety</b>	IEC 61010	
<b>Insulation</b>	Impulse, protective class II - IEC 62052-11	6KV/500Ω @ 1.2/50 μs
	Dielectric withstand, protective class II - IEC 62053-22	4 KV r.m.s. @ 1mn
<b>Measurements and Accuracy</b>	IEC 62052-11	
	IEC 62053-22 - Active Energy measurement	Class 0.2S
	IEC 62053-23 - Reactive Energy measurement	Class 0.5S
<b>Power Quality</b>	PQ methods - IEC 61000-4-30	Class A
	Harmonics & Interharmonics measurements - IEC 61000-4-7	Class I
	Flicker measurements - IEC 61000-4-15	Class I
	Report - EN50160	



## Measurement Specifications

Parameter	Full Scale @ Input Range	Accuracy			Range
		% Reading	% FS	Conditions	
Voltage V1-V3 (L-n)	230 x PT ratio @ 230V	0.05	±0.05	1% up to 140%	0 up to 999,000 V
Voltage V4 (calculated)	230 x PT ratio @ 230V		±0.5	5% up to 140%	
Voltage V1-V3 (L-n)	69 x PT ratio	0.1	±0.05	1% up to 140%	0 up to 999,000 V
Voltage V4 (calculated)	69 x PT ratio		±0.5	5% up to 140%	
Line current I1- I4	CT primary current	±0.06	±0.06	1% up to 120% In	0 up to 20,000 A
Fault current I1- I4	CT primary current	±0.5	-	120%- 1000% In	0 up to 100,000 A
Active power	3xV FS×CT/1000	0.2	0.02	PF  ≥ 0.5 *	-10,000,000 kW to +10,000,000 kW
Reactive power	3xV FS×CT/1000	0.3	0.04	PF  ≤ 0.9 *	-10,000,000 kvar to +10,000,000 kvar
Apparent power	3xV FS×CT/1000	0.2	0.02	PF  ≥ 0.5 *	0 to 10,000,000 kVA
Power factor	1.000		0.2	PF  ≥ 0.5, I ≥ 2% FSI	-0.999 to +1.000
Frequency	50 Hz	-	±0.02	40-65 Hz	40.00 up to 64.99 Hz
	60 Hz	-	±0.02	45- 70 Hz	45.00 up to 69.99 Hz
Total Harmonic Distortion, THD V (I), %V <sub>f</sub> (%I <sub>f</sub> )	999.9	1.5	0.1	THD ≥ 1%, V (I) ≥ 10% FSV (FSI)	0 to 999.9
Total Demand Distortion, TDD, %	100		1.5	TDD ≥ 1%, I ≥ 10% FSI	0 to 100
Active energy Import & Export		IEC 62053-22 Class 0.2S			0 to 999,999.999 MWh
Reactive energy Import & Export		Class 0.5S under conditions as per IEC 62053-22:2003 @ 0 ≤  PF  ≤ 0.9			0 to 999,999.999 Mvarh
Apparent energy		Class 0.2S under conditions as per IEC 62053-22:2003			0 to 999,999.999 MVAh
Symmetrical components	Voltage FS	1.0		10% - 120% FS	
	Current FS	1.0		10% - 200% FS	
	Current FS	3.0		200% - 3000%FS	
Phasor angles		1 degree			

\* @ 80% to 120% of voltage FS, 2% to 200% of current FS, and frequency 50/60 Hz  
PT - external potential transformer ratio  
CT - primary current rating of external current transformer  
FSV - voltage full scale  
FSI - current full scale  
V<sub>f</sub> - fundamental voltage  
I<sub>f</sub> - fundamental current

### NOTES

- Accuracy is expressed as ± (percentage of reading + percentage of full scale) ± 1 digit. This does not include inaccuracies introduced by the user's potential and current transformers. Accuracy calculated at 1second average.
- Specifications assume: voltage and current waveforms with THD ≤ 5% for kvar, kVA and PF, and reference operating temperature 20°C - 26°C.
- Measurement error is typically less than the maximum error indicated