

Series PM172 Powermeters

PM172P/PM172E/PM172EH

Installation and Operation Manual



LIMITED WARRANTY

The manufacturer offers the customer a 24-month functional warranty on the instrument for faulty workmanship or parts from date of dispatch from the distributor. In all cases, this warranty is valid for 36 months from the date of production. This warranty is on a return to factory basis.

The manufacturer does not accept liability for any damage caused by instrument malfunction. The manufacturer accepts no responsibility for the suitability of the instrument to the application for which it was purchased.

Failure to install, set up or operate the instrument according to the instructions herein will void the warranty.

Only a duly authorized representative of the manufacturer may open your instrument. The unit should only be opened in a fully anti-static environment. Failure to do so may damage the electronic components and will void the warranty.

The greatest care has been taken to manufacture and calibrate your instrument. However, these instructions do not cover all possible contingencies that may arise during installation, operation or maintenance, and all details and variations of this equipment are not covered by these instructions.

For additional information regarding installation, operation or maintenance of this instrument, contact the manufacturer or your local representative or distributor.

WARNING

Read the instructions in this manual before performing installation, and take note of the following precautions:

- ⇒ Ensure that all incoming AC power and other power sources are turned OFF before performing any work on the instrument. Failure to do so may result in serious or even fatal injury and/or equipment damage.
- ⇒ Before connecting the instrument to the power source, check the labels on the back of the instrument to ensure that your instrument is equipped with the appropriate power supply voltage, input voltages and currents.
- ⇒ Under no circumstances should the instrument be connected to a power source if it is damaged.
- ⇒ To prevent potential fire or shock hazard, do not expose the instrument to rain or moisture.
- ⇒ The secondary of an external current transformer must never be allowed to be open circuit when the primary is energized. An open circuit can cause high voltages, possibly resulting in equipment damage, fire and even serious or fatal injury. Ensure that the current transformer wiring is secured using an external strain relief to reduce mechanical strain on the screw terminals, if necessary.
- ⇒ Only qualified personnel familiar with the instrument and its associated electrical equipment must perform setup procedures.
- ⇒ Do not open the instrument under any circumstances when it is connected to a power source.
- ⇒ Do not use the instrument for primary protection functions where failure of the device can cause fire, injury or death. The instrument can only be used for secondary protection if needed.

Read this manual thoroughly before connecting the device to the current carrying circuits. During operation of the device, hazardous voltages are present on input terminals. Failure to observe precautions can result in serious or even fatal injury or damage to equipment.

All trademarks are property of their respective owners.

Copyright © 2005-2008

Table of Contents

| | | |
|------------------|------------------------------------|-----------|
| Chapter 1 | General Information | 6 |
| Chapter 2 | Installation | 10 |
| | Mechanical Installation | 10 |
| | Panel Mounting | 10 |
| | DIN Rail Mounting | 13 |
| | Remote Display Installation | 14 |
| | Mechanical Installation | 14 |
| | Electrical Connection | 16 |
| | Electrical Installation | 17 |
| | Typical Installation | 17 |
| | Terminals | 18 |
| | Power Source Connection | 18 |
| | Chassis Ground Connection | 19 |
| | Wiring Diagrams | 19 |
| | I/O Connections | 24 |
| | Relay Outputs | 24 |
| | Digital Inputs | 24 |
| | Analog Outputs | 25 |
| | Analog Inputs | 25 |
| | Communications Connections | 26 |
| | COM1 RS-232 Connection | 26 |
| | COM1 RS-422/485 Connection | 27 |
| | COM1 Dial Up Modem Connection | 28 |
| | COM1 Ethernet Connection | 28 |
| | COM1 Profibus Connection | 29 |
| | COM2 RS-422/485 Connection | 30 |
| Chapter 3 | Display Operations | 32 |
| | Indicators and Controls | 32 |
| | Display Diagnostics | 32 |
| | Numeric LED Display | 32 |
| | Load Bar Graph | 33 |
| | Energy Pulse LED | 33 |
| | Port Activity LEDs | 33 |
| | Navigation Buttons | 33 |
| | Data Display | 33 |
| | Display Features | 33 |
| | Navigation Buttons | 34 |
| | Simple Reset of Accumulated Data | 35 |
| | Common Measurements Display | 35 |
| | Min/Max and Max. Demands Display | 36 |
| | Harmonics Display | 37 |
| | Energy Display | 38 |
| | Status Display | 39 |
| | Using the Menu | 40 |
| | Navigation Buttons | 40 |
| | Selecting Menus | 40 |
| | Entering the Password | 41 |
| | Selecting a Menu Entry | 41 |
| | Viewing and Changing Setup Items | 41 |
| | Menu Operations | 42 |
| | Basic Device Settings | 42 |

| | |
|---|------------|
| Device Options..... | 43 |
| Transformer Correction..... | 44 |
| Communication Ports | 45 |
| Network Address..... | 46 |
| Counters Setup | 47 |
| Relay Output Setup..... | 47 |
| Control Setpoints Setup..... | 48 |
| Analog Inputs Setup..... | 49 |
| Analog Outputs Setup..... | 50 |
| Analog Expander Setup | 51 |
| Timers Setup | 52 |
| Display Setup..... | 52 |
| Meter Security..... | 53 |
| Setting the Device Clock..... | 54 |
| Resetting Accumulators and Maximum Demands..... | 55 |
| Chapter 4 PAS Application Software..... | 56 |
| Configuration Database | 56 |
| Setting up Communications..... | 56 |
| Communicating through a Serial Port | 57 |
| Communicating through a Dial-up Modem | 58 |
| Communicating through the Internet..... | 58 |
| Setting Up the Meter..... | 59 |
| Downloading Setup to the Meter | 59 |
| Uploading Setup from the Meter | 59 |
| Authorization..... | 59 |
| Configuring Communications in your Meter | 60 |
| Setting Up Communication Ports | 60 |
| Setting Up the Ethernet | 61 |
| Configuring GE EGD Production Exchanges | 62 |
| General Meter Setup..... | 64 |
| Basic Meter Setup | 64 |
| Device Options..... | 65 |
| Transformer Correction..... | 67 |
| Local Settings | 68 |
| Using Digital Inputs..... | 69 |
| Using Relay Outputs..... | 70 |
| Programming Analog Inputs | 72 |
| Programming Analog Outputs | 74 |
| Programming the Analog Expander | 75 |
| Using Counters | 76 |
| Using Periodic Timers | 77 |
| Using Control Setpoints | 78 |
| Configuring Summary Energy and TOU Registers | 83 |
| Setting up Total and Tariff Registers | 83 |
| Configuring the Daily Tariff Schedule..... | 84 |
| Configuring the Season Tariff Schedule | 85 |
| Configuring Recorders..... | 87 |
| Configuring Device Memory | 87 |
| Configuring the Event Recorder..... | 88 |
| Configuring the Data Recorder | 89 |
| Configuring the Waveform Recorder..... | 91 |
| Configuring Communication Protocols | 94 |
| Configuring Modbus | 94 |
| Configuring DNP3..... | 95 |
| Remote Device Control | 100 |
| Remote Relay Control..... | 100 |
| Event Flags..... | 100 |
| Device Diagnostics | 101 |

| | |
|---|------------|
| Updating the Clock | 102 |
| Resetting Accumulators and Clearing Log Files | 102 |
| Administration | 103 |
| Changing a Password | 103 |
| Upgrading Device Firmware | 103 |
| Monitoring Devices..... | 106 |
| Viewing Real-time Data | 106 |
| Viewing Min/Max Log | 106 |
| Viewing Real-time Waveforms..... | 106 |
| Viewing Harmonic Spectrum and Synthesized Waveforms..... | 107 |
| Viewing Recorded Files | 107 |
| Retrieving Logs Files..... | 107 |
| Viewing Options | 107 |
| Viewing the Device Event Log | 108 |
| Viewing the Data Log | 109 |
| Viewing Waveforms..... | 109 |
| Viewing Synchronized Waveforms | 114 |
| COMTRADE and PQDIF Converters | 116 |
| Manual Converting | 116 |
| Automatic Converting | 117 |
| Appendix A Technical Specifications..... | 118 |
| Appendix B Analog Output Parameters | 124 |
| Appendix C Setpoint Triggers and Actions | 125 |
| Appendix D Parameters for Data Log and Monitoring..... | 128 |
| Appendix E Data Scales | 136 |
| Appendix F Device Diagnostic Codes | 137 |

Chapter 1 General Information



The PM172 is a compact, multi-function, three-phase AC powermeter specially designed to meet the requirements of users ranging from electrical panel builders to substation operators.

Bright 3-row LED display provides easy local meter readings. The display module is freely detachable and can be located at a distance of up to 1000 meters from the device.

Two communication ports allow local and remote automatic meter readings and setup through the supplemental communication or user data acquisition software. Different communication options are available for remote communications with the meter including public telephone lines, LAN and the Internet.

The PM172 Series product line includes three models of devices:

- PM172P - basic model - offers all standard metering and control capabilities of the PM172 Series
- PM172E - adds to above an energy meter, an event recorder and a multi-channel data recorder.
- PM172EH - adds to above extended harmonic analysis and incorporates a fast waveform recorder with the voltage disturbance monitor.

Features:

- 3 voltage and 3 current transformer-isolated AC inputs for direct connection to power line or via potential and current transformers
- Multi-function 3-phase meter (true RMS, volts, amps, power, power factor, neutral current, voltage and current unbalance, frequency)
- Embedded harmonic analyzer, voltage and current THD, current TDD and K-Factor, up to 40th order harmonic
- Voltage and current harmonic spectrum and angles, harmonics power and energy (PM172EH)
- Ampere/Volt/THD/TDD demand meter
- Class 0.2 four-quadrant energy meter
- Time-of-Use, 8 totalization and tariff energy/demand registers x 8 tariffs, 4 seasons x 4 types of days, 8

tariff changes per day, easy programmable tariff schedule

- Automatic daily profile for energy and maximum demand readings (total and tariff registers)
- Embedded programmable controller; 16 control setpoints; programmable thresholds and delays; relay output control; 1-cycle response time
- Event recorder for logging internal diagnostics events, control events and I/O operations (PM172E, PM172EH)
- Eight data recorders; programmable data logs on a periodic basis and on any internal and external trigger (PM172E, PM172EH)
- Two waveform recorders; simultaneous 6-channel AC recording in a single plot; sampling rate of 32 and 128 samples per cycle; 20 pre-fault cycles; up to 30 seconds of continuous recording at a rate of 32 samples per cycle (PM172EH)
- Real-time waveform capture and monitoring; simultaneous 6-channel 4-cycle capture at 128 samples per cycle (PM172EH)
- Easy to read 3-row (2x4 characters + 1x6 characters) bright LED display, adjustable update time, auto-scroll option with adjustable page exposition time, auto-return to a default page
- LED bar graph showing percent load with respect to user-definable nominal load current
- Detachable display module with a 3-wire RS-485 interface; up to 1000 meters operation
- 2 digital inputs for monitoring external contacts, and receiving pulses from energy, water and gas meters
- 2 relay outputs for alarms and controls, and for output energy pulses
- 2 optional optically isolated analog outputs with an internal power supply; options for 0-20mA, 4-20mA, 0-1mA, and ± 1 mA output
- 2 optional optically isolated analog inputs with an internal power supply; options for 0-20mA, 4-20mA, 0-1mA, and ± 1 mA input
- Optional analog expander providing additional 2 x 8 analog outputs; options for 0-20mA, 4-20mA, 0-1mA, and ± 1 mA
- 25/50/60/400 Hz operation
- Precise internal clock with battery backup
- 1 Mbyte RAM with battery backup for long-term data and waveform recording
- Two communication ports; communications options available:
 - COM1:
 - RS-232/RS-422/RS-485
 - 56K Dial-up modem
 - Ethernet 10/100BaseT, eXpertPower™ enabled
 - Profibus DP

COM2:

RS-422/RS-485

- Modbus RTU, Modbus/TCP, DNP3, DNP3/TCP, GE EGD producer, Profibus DP and proprietary ASCII communication protocols
- Easy field upgrading device firmware through any communication port

Measured Parameters

| Parameter | Display | Comm. | Analog | Pulse | Alarm |
|---|---------|-------|--------|-------|-------|
| 1-cycle Real-time Measurements | | | | | |
| RMS Voltage per phase | | ✓ | ✓ | | ✓ |
| RMS Current per phase | | ✓ | ✓ | | ✓ |
| kW per phase | | ✓ | | | ✓ |
| kvar per phase | | ✓ | | | ✓ |
| kVA per phase | | ✓ | | | ✓ |
| Power Factor per phase | | ✓ | | | ✓ |
| Total kW | | ✓ | ✓ | | ✓ |
| Total kvar | | ✓ | ✓ | | ✓ |
| Total kVA | | ✓ | ✓ | | ✓ |
| Frequency | | ✓ | ✓ | | ✓ |
| Neutral Current | | ✓ | ✓ | | ✓ |
| Total Power Factor | | ✓ | ✓ | | ✓ |
| Voltage & Current unbalance | | ✓ | | | ✓ |
| 1-sec Average Measurements | | | | | |
| RMS Voltage per phase | ✓ | ✓ | ✓ | | ✓ |
| RMS Current per phase | ✓ | ✓ | ✓ | | ✓ |
| kW per phase | ✓ | ✓ | | | ✓ |
| kvar per phase | ✓ | ✓ | | | ✓ |
| kVA per phase | ✓ | ✓ | | | ✓ |
| Power Factor per phase | ✓ | ✓ | | | ✓ |
| Total kW | ✓ | ✓ | ✓ | | ✓ |
| Total kvar | ✓ | ✓ | ✓ | | ✓ |
| Total kVA | ✓ | ✓ | ✓ | | ✓ |
| Total Power Factor | ✓ | ✓ | ✓ | | ✓ |
| Frequency | ✓ | ✓ | ✓ | | ✓ |
| Neutral Current | ✓ | ✓ | ✓ | | ✓ |
| Voltage & Current unbalance | ✓ | ✓ | | | ✓ |
| Amps & Volt Demands | | | | | |
| Ampere & Volt Demand per phase | | ✓ | | | ✓ |
| Ampere Maximum Demand per phase | ✓ | ✓ | | | ✓ |
| Voltage Maximum Demand per phase | ✓ | ✓ | | | ✓ |
| Power Demands^{E, EH} | | | | | |
| kW Accumulated Demand Import & Export | | ✓ | ✓ | | ✓ |
| kvar Accumulated Demand Import & Export | | ✓ | ✓ | | ✓ |
| kVA Accumulated Demand | | ✓ | ✓ | | ✓ |
| kW Demand Import & Export | | ✓ | | | ✓ |
| kvar Demand Import & Export | | ✓ | | | ✓ |
| kVA Demand | | ✓ | | | ✓ |
| kW Sliding Demand Import & Export | | ✓ | | | ✓ |
| kvar Sliding Demand Import & Export | | ✓ | | | ✓ |
| kVA Sliding Demand | | ✓ | | | ✓ |
| kW Predicted Demand Import & Export | | ✓ | | | ✓ |
| kvar Predicted Demand Import & Export | | ✓ | | | ✓ |
| kVA Predicted Demand | | ✓ | | | ✓ |
| kW Maximum Demand Import | ✓ | ✓ | | | |
| kW Maximum Demand Export | | ✓ | | | |
| kvar Maximum Demand Import | ✓ | ✓ | | | |
| kvar Maximum Demand Export | | ✓ | | | |
| kVA Maximum Demand | ✓ | ✓ | | | |
| Total Energy^{E, EH} | | | | | |
| Total kWh Import & Export | ✓ | ✓ | | ✓ | |
| Total kvarh Import & Export | ✓ | ✓ | | ✓ | |
| Total kvarh Net | | ✓ | | | |

| Parameter | Display | Comm. | Analog | Pulse | Alarm |
|---|---------|-------|--------|-------|-------|
| Total kVAh | ✓ | ✓ | | ✓ | |
| Energy per Phase E, EH | | | | | |
| kWh Import per phase | ✓ | ✓ | | | |
| kvarh Import per phase | | ✓ | | | |
| kVAh per phase | ✓ | ✓ | | | |
| TOU Registers E, EH | | | | | |
| 8 TOU energy registers (kWh and kvarh import & export, kVAh, 2 pulse sources) | ✓ | ✓ | | | |
| 8 TOU maximum demand registers | | ✓ | | | |
| 8 tariffs, 4 seasons x 4 types of day | | ✓ | | | ✓ |
| Harmonic Measurements | | | | | |
| Voltage THD per phase | ✓ | ✓ | ✓ | | ✓ |
| Current THD per phase | ✓ | ✓ | ✓ | | ✓ |
| Current TDD per phase | ✓ | ✓ | ✓ | | ✓ |
| K-factor per phase | ✓ | ✓ | ✓ | | ✓ |
| Voltage harmonics per phase up to order 40 | ✓ EH | ✓ EH | | | |
| Current harmonics per phase up to order 40 | ✓ EH | ✓ EH | | | |
| Voltage harmonic angles up to order 40 | | ✓ EH | | | |
| Current harmonic angles up to order 40 | | ✓ EH | | | |
| Total Harmonic Powers EH | | | | | |
| Total Harmonic kW | ✓ | ✓ | | | ✓ |
| Total Harmonic kVA | ✓ | ✓ | | | ✓ |
| Total Harmonic Energy EH | | | | | |
| Total Harmonic kWh Import & Export | ✓ | ✓ | | | |
| Total Harmonic kVAh | ✓ | ✓ | | | |
| Fundamental Component | | | | | |
| Voltage and Current per phase | | ✓ | | | |
| kW, PF per phase | ✓ | ✓ | | | |
| kvar, KVA per phase | | ✓ | | | |
| Total kW, PF | ✓ | ✓ | | | |
| Total kvar, KVA | | ✓ | | | |
| Min/Max Logging | | | | | |
| Min/Max A, V, total kW, kvar, kVA, PF | ✓ | ✓ | | | |
| Min/Max Frequency, Neutral current | ✓ | ✓ | | | |
| Min/Max THD, TDD, K-Factor per phase | | ✓ | | | |
| Voltage Disturbance EH | | | | | ✓ |
| Phase Rotation | ✓ | | | | ✓ |
| Voltage and Current Phase Angles | ✓ | ✓ | | | |
| Day and Time | ✓ | ✓ | | | ✓ |
| Pulse Counters | ✓ | ✓ | | | ✓ |
| Analog Inputs (optional) | ✓ | ✓ | | | ✓ |
| Digital Inputs | ✓ | ✓ | | | ✓ |
| Relay Outputs | ✓ | ✓ | | | ✓ |
| Remote Relay Control | | ✓ | | | |
| Alarm Triggers/Setpoints | | ✓ | | | ✓ |
| Self-diagnostics | | ✓ | | | |

Designations used in the manual:

E - available in the PM172E and PM172EH

EH - available in the PM172EH

Chapter 2 Installation

Mechanical Installation

Panel Mounting

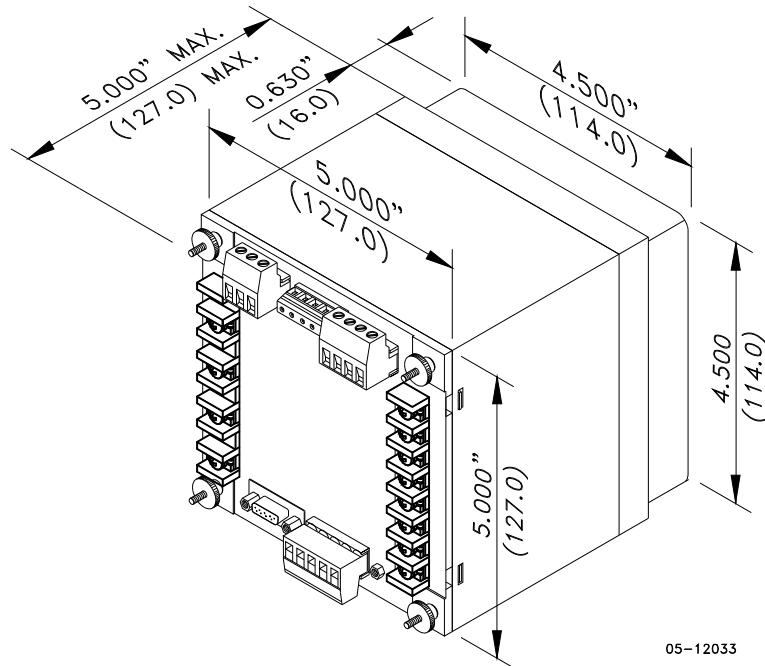

05-12033

Figure 2-1 Dimensions

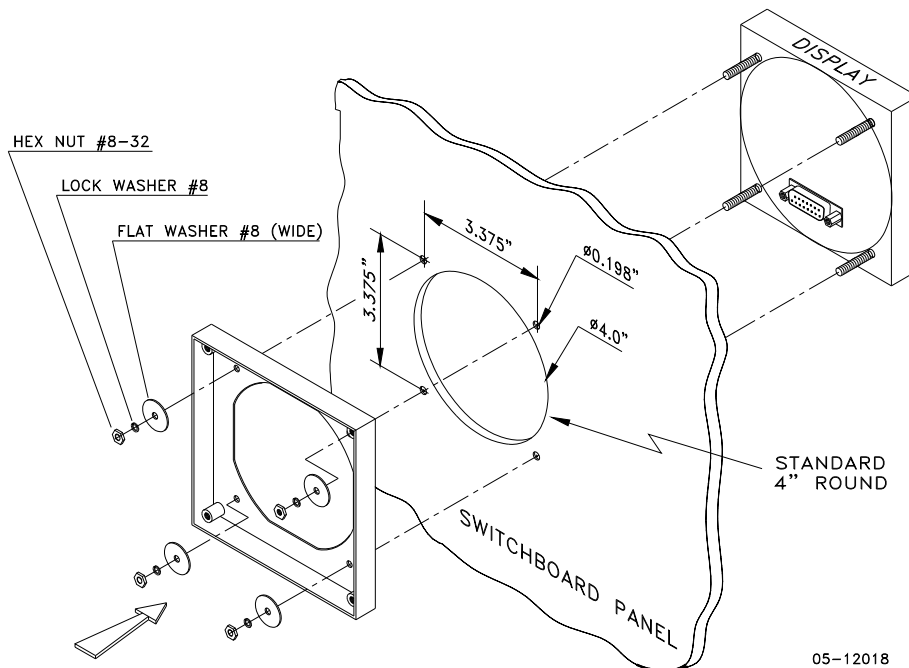

05-12018

Figure 2-2 STEP 1 (ANSI 4" round cutout): Mount the display module in cutout

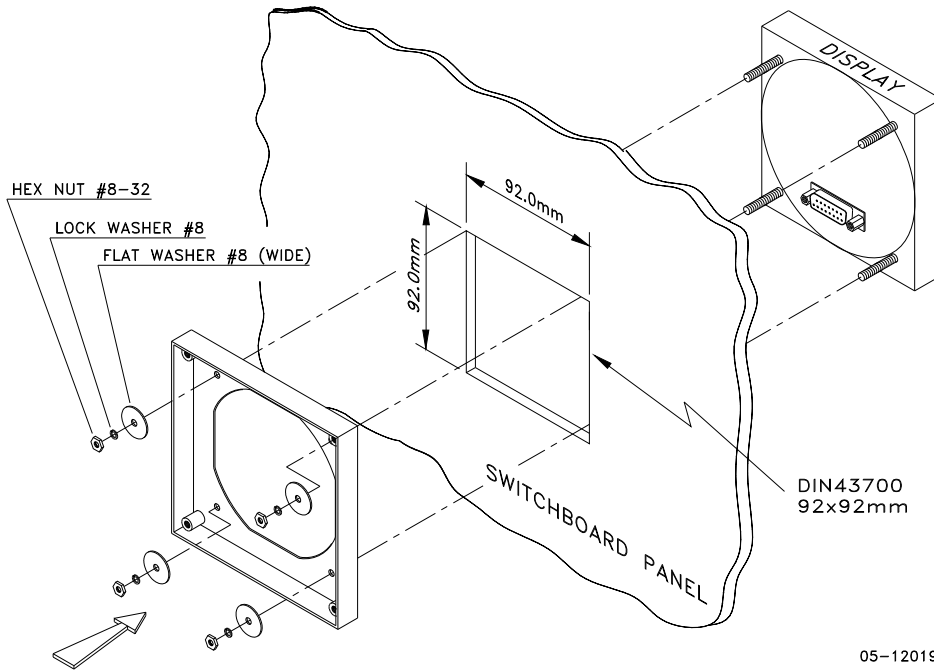

Figure 2-3 STEP 1 (DIN 92x92mm square cutout): Mount the display module in cutout

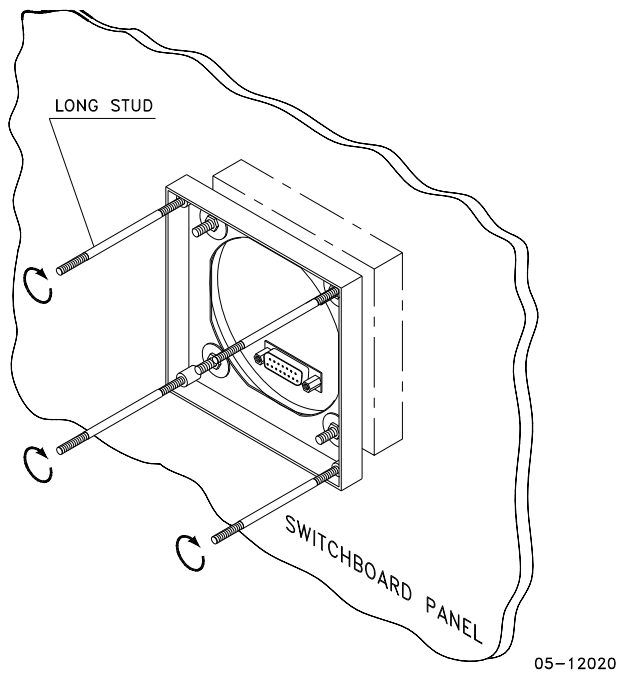

Figure 2-4 STEP 2: Assemble the four locating studs

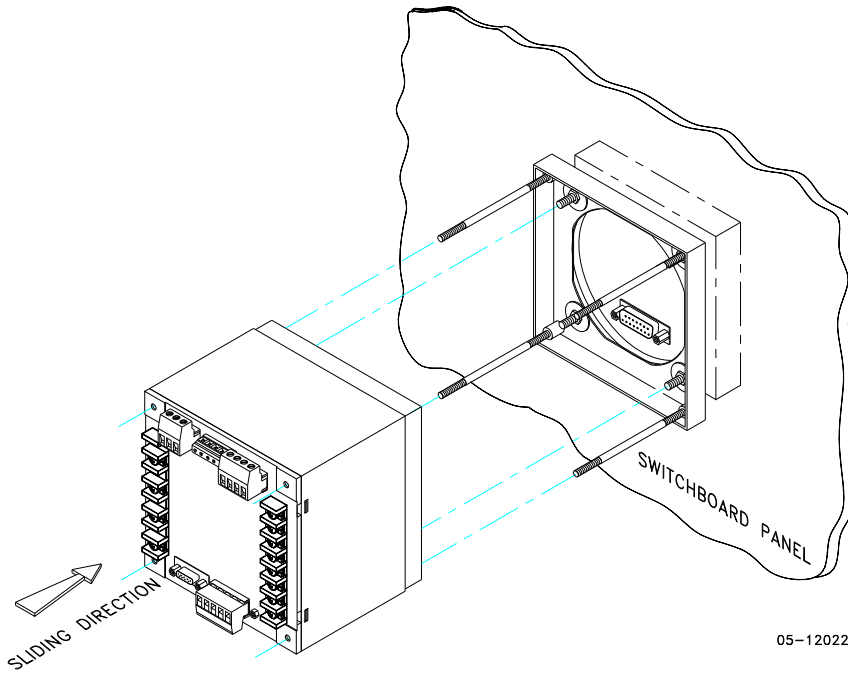

Figure 2-5 STEP 3: Slide and position the meter on locating studs

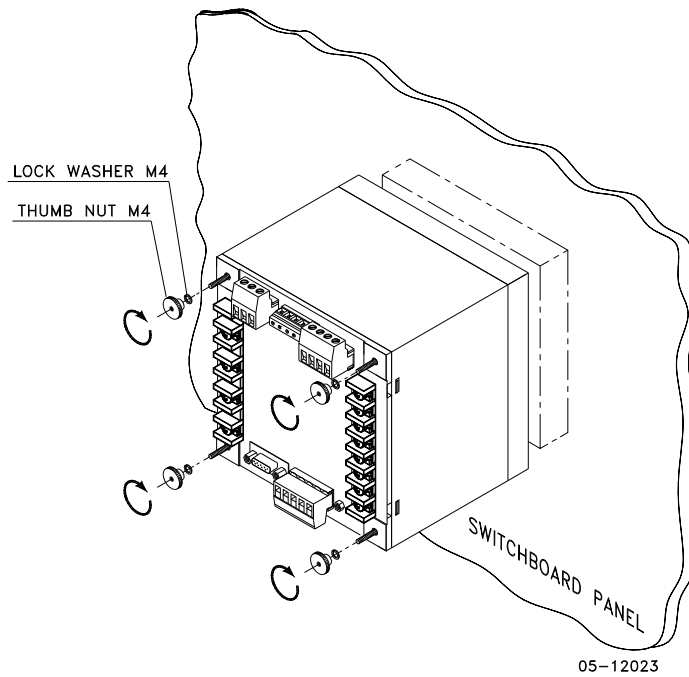
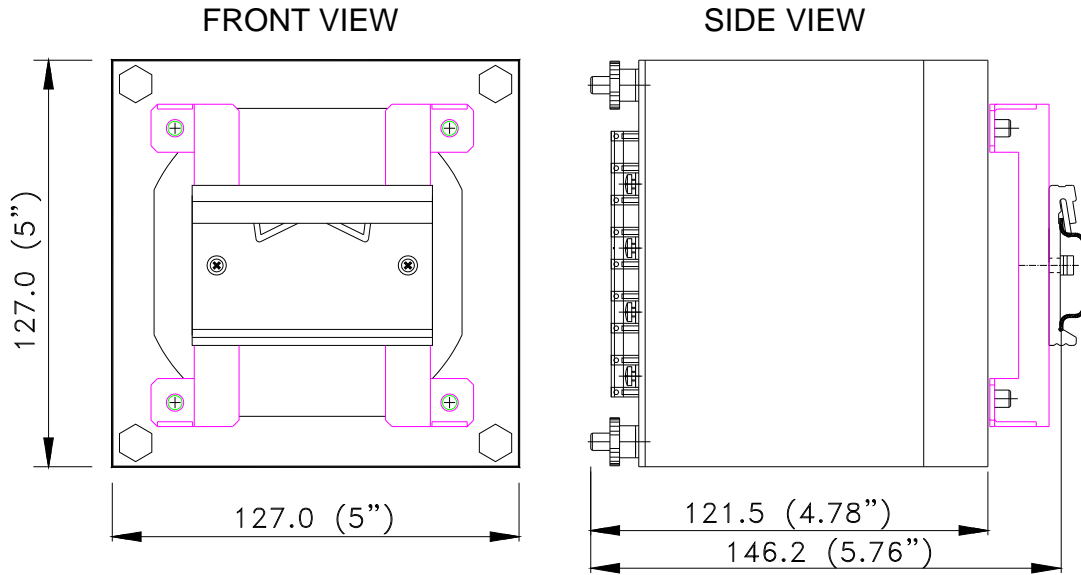

Figure 2-6 STEP 4: Affix the meter using the thumb nuts

DIN Rail Mounting

The PM172 can be mounted on a 35-mm DIN rail. The display module is mounted separately on the switchboard panel and is connected to the meter by a communication cable (see “Remote Display Installation”).



BG0386-1

Figure 2-7 Dimensions

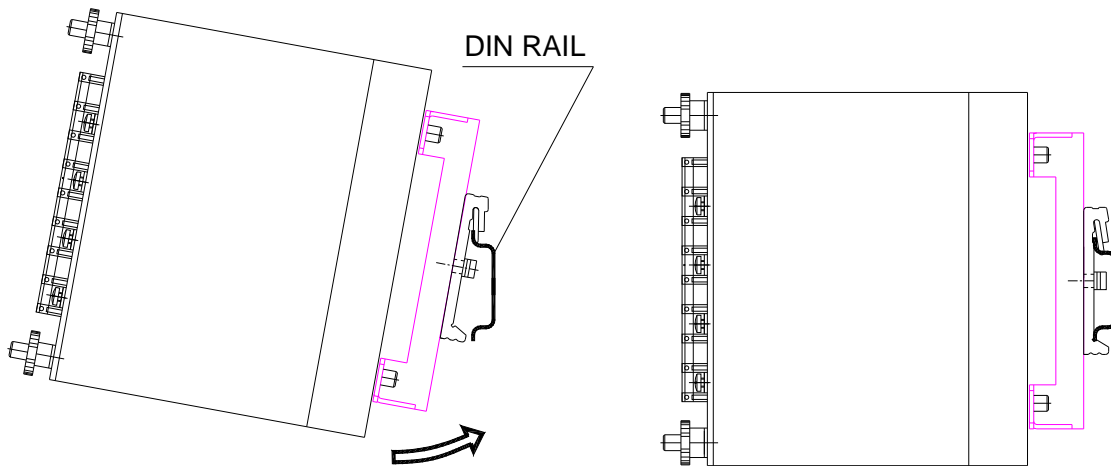

BG0386-2

Figure 2-8 DIN rail mounting

Remote Display Installation

Mechanical Installation

Standard Cutouts (ANSI 4" round or DIN 92x92 mm square)

Figure 2-9 Display cutout dimensions

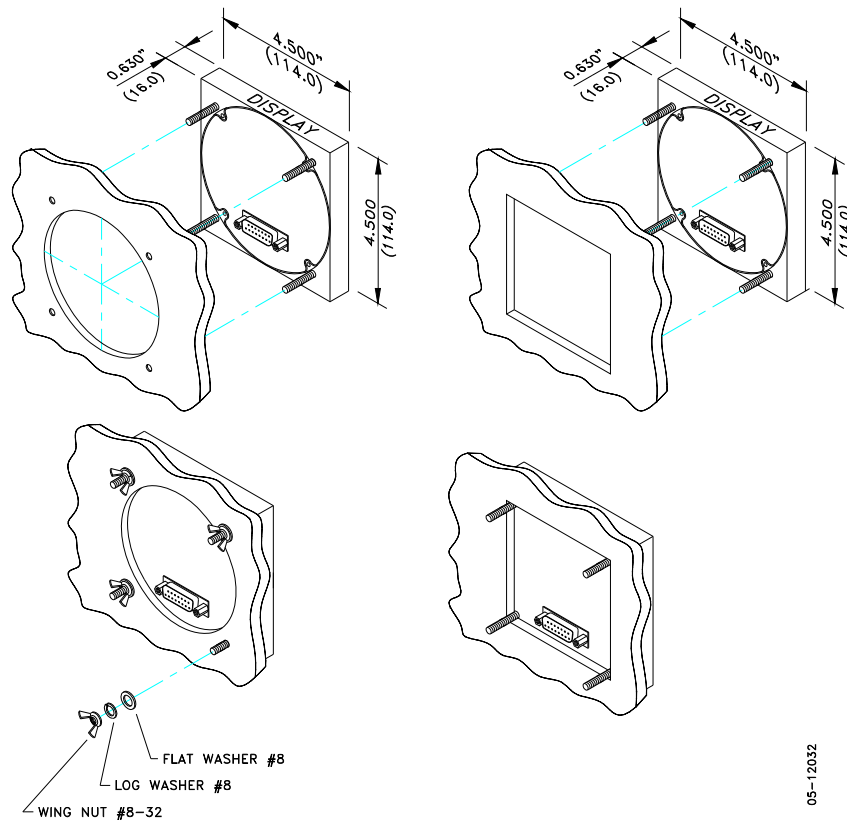

STEP 1: Insert the display module into cutout.
STEP 2: Fasten washers and nut on screws.

Figure 2-10 ANSI 4" or DIN 92x92 mm display mounting

Special Cutout

Figure 2-11 Panel cutout dimensions

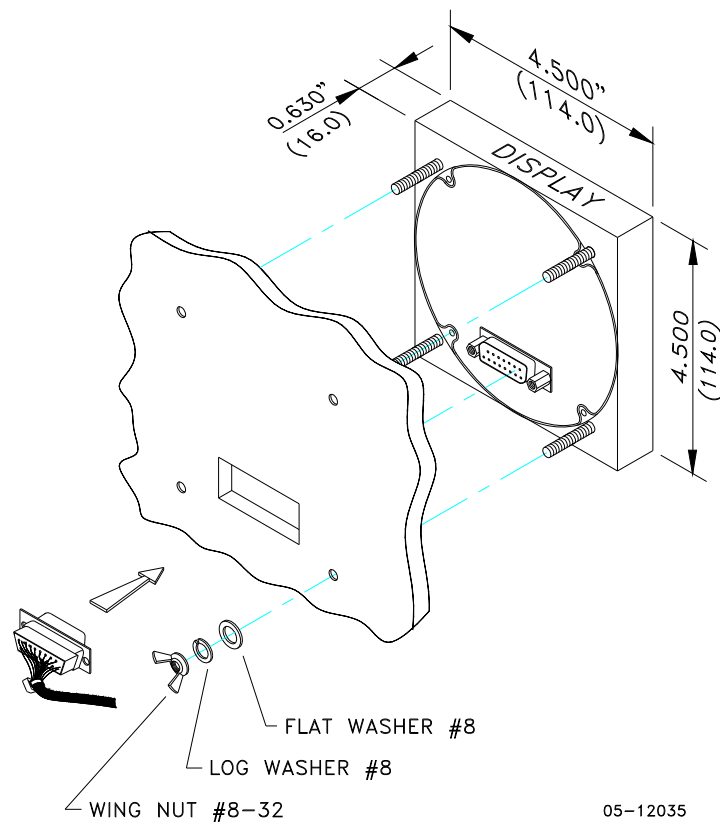

Figure 2-12 Display mounting

Electrical Connection

The remote display is connected to the meter via a 3-wire or 5-wire communication cable provided with two 15-pin D-type connectors.

At distances of up to 3 m, the display can receive power through the communication cable directly from the meter. Connect pins 1 and 8 on both sides as shown in Figure 2-13.

At distances above 3 m, power should be provided from a separate 12V DC power source (a 12V AC/DC adapter can be used). Connect the positive wire to pin 1 and the negative wire to pin 8 as shown in Figure 2-14.

| Pin | Signal |
|-----|------------------|
| 1 | +12V |
| 5 | RS-485 + (plus) |
| 7 | RS-485 - (minus) |
| 8 | GND |
| 15 | Chassis ground |

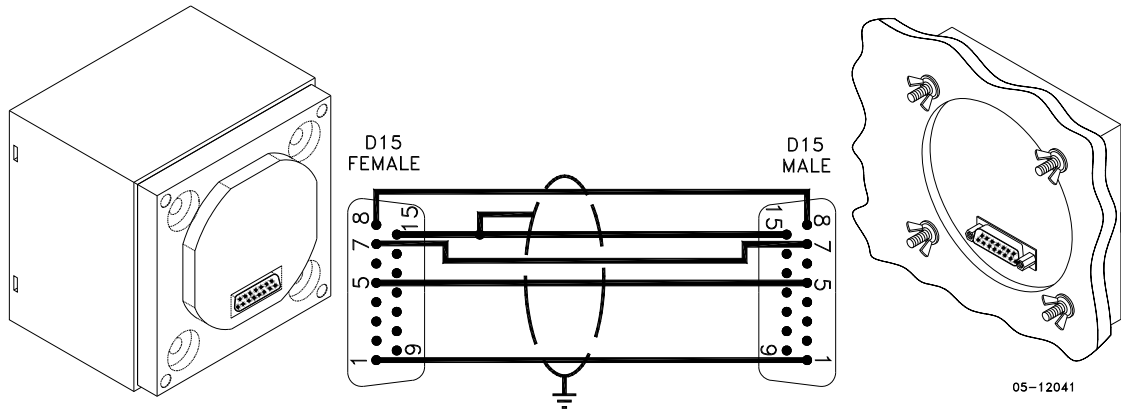

Figure 2-13 Self-powered remote display connection

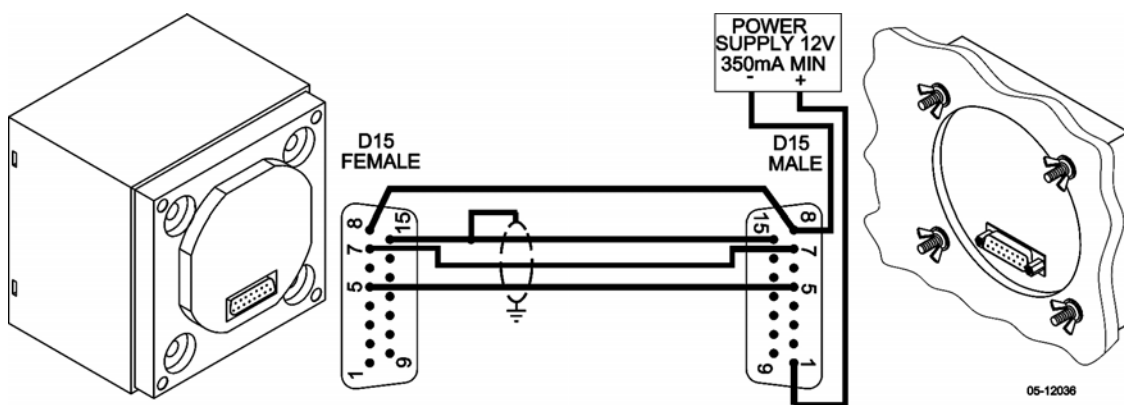

Figure 2-14 Remote display powered from a 12V DC power source

If required, the remote display may be connected to one of the regular meter ports COM1 or COM2 via a three-wire RS-485 communication cable using a separate 12V DC power source as shown in Figure 2-14. See [Communications Connections](#) for connector pin-outs and connection diagrams. The meter port settings must be as follows: Modbus RTU protocol, RS-485 interface, 19200 baud, 8-bits/no parity.

Electrical Installation

Before installation ensure that all incoming power sources are shut OFF. Failure to observe this practice can result in serious or even fatal injury and damage to equipment.

Typical Installation

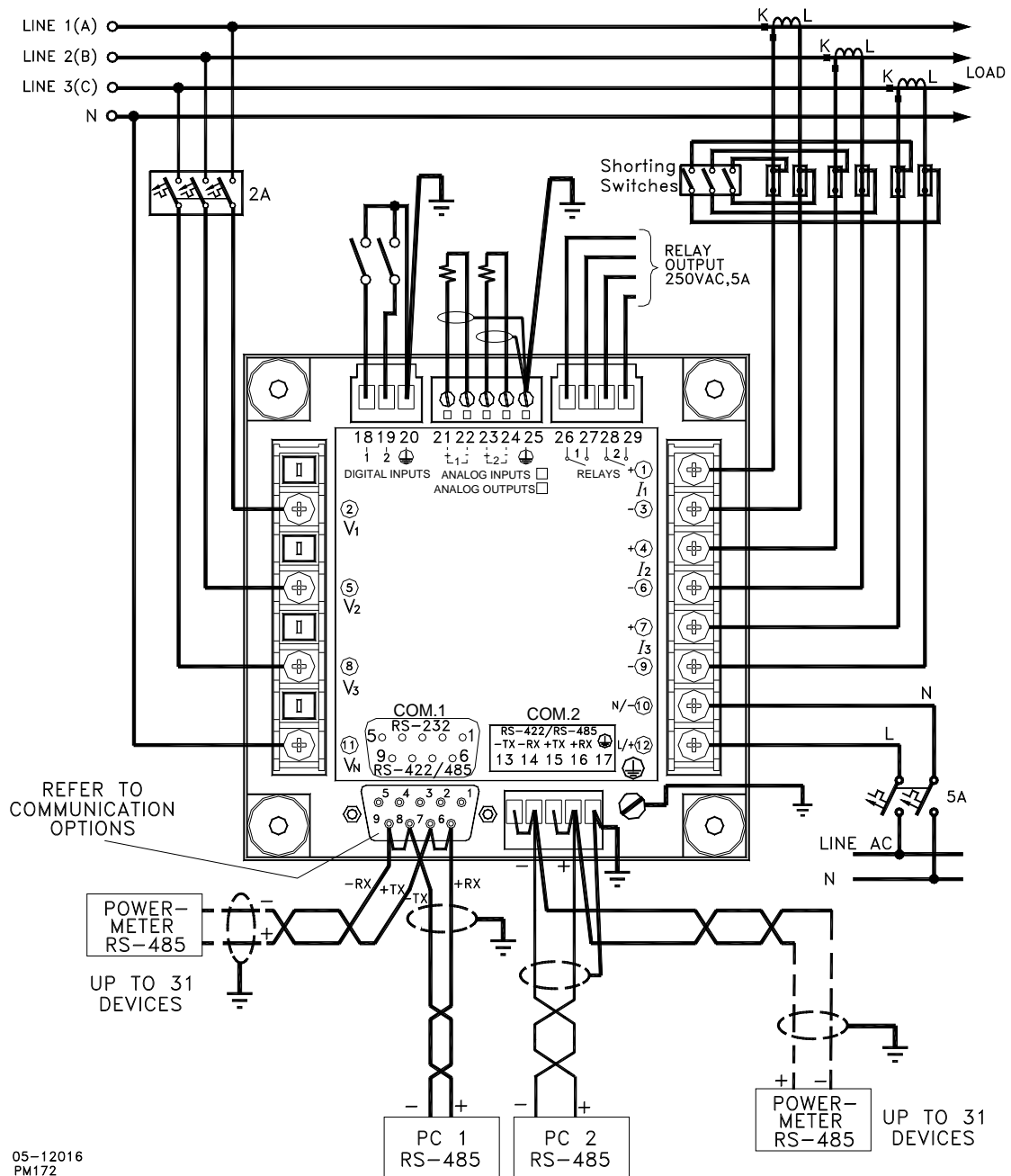

05-12016
PM172

Figure 2-15 Typical Installation

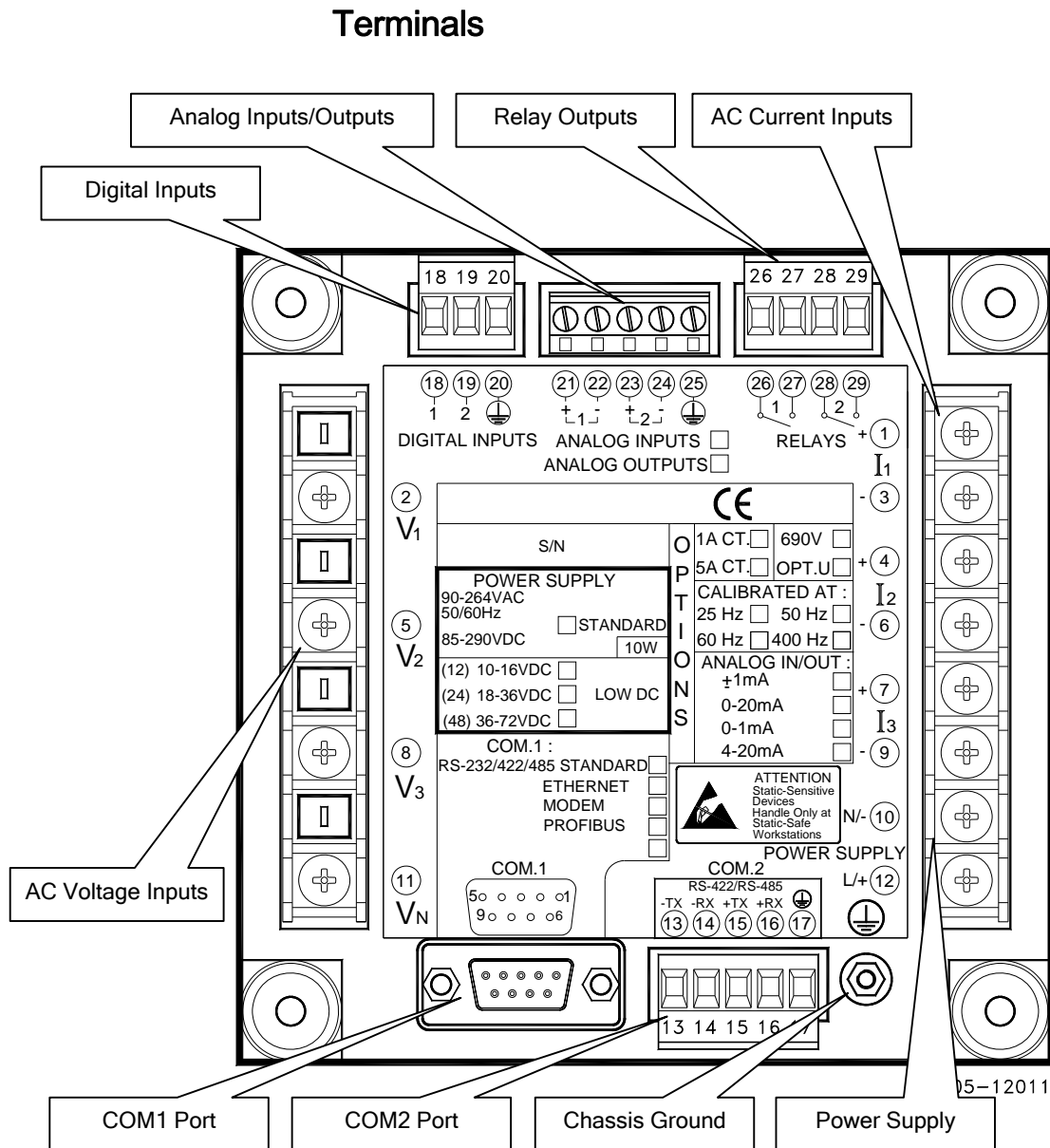

Figure 2-16 Terminals - Rear View

Power Source Connection

Before connecting your meter to the power source, check the label on the back of the device to ensure that it is equipped with the appropriate power supply.

The power source can be dedicated-fused, or from a monitored voltage if it is within the instrument power supply range.

AC power supply: connect the line wire to terminal 12 and the neutral wire to terminal 10.

DC power supply: connect the positive wire to terminal 12 and the negative wire to terminal 10.

Chassis Ground Connection

Connect the chassis ground of the device to the switchgear earth ground using a dedicated wire greater than 2 mm²/14 AWG.

Wiring Diagrams

For AC input ratings, see “Technical Specifications” in Appendix A.

The following wiring configurations are available in the meter:

| Wiring Configuration (See Basic Device Settings in Chapter 3) | Setup Code | Figure |
|--|----------------|--------|
| 3-wire 2-element Direct connection using 2 CTs | 3dir2 | 2-17 |
| 4-wire Wye 3-element direct connection using 3 CTs | 4Ln3 or 4LL3 | 2-18 |
| 4-wire Wye 3-element connection using 3 PTs, 3 CTs | 4Ln3 or 4LL3 | 2-19 |
| 3-wire 2-element Open Delta connection using 2 PTs, 2 CTs | 3OP2 | 2-20 |
| 4-wire Wye 2½ -element connection using 2 PTs, 3 CTs | 3Ln3 or 3LL3 | 2-21 |
| 3-wire 2½ -element Open Delta connection using 2 PTs, 3 CTs | 3OP3 | 2-22 |
| 4-wire 3-element Delta direct connection using 3 CTs | 4Ln3 or 4LL3 | 2-23 |
| 3-wire 2½-element Broken Delta connection using 2 PTs, 3 CTs | 3bLn3 or 3bLL3 | 2-24 |

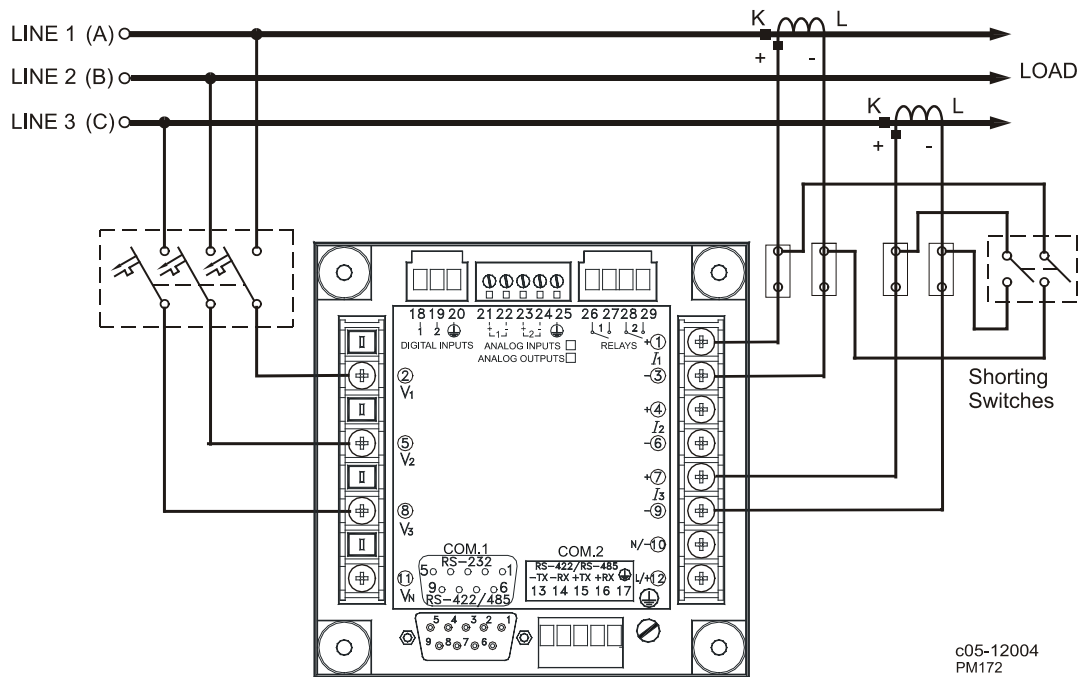
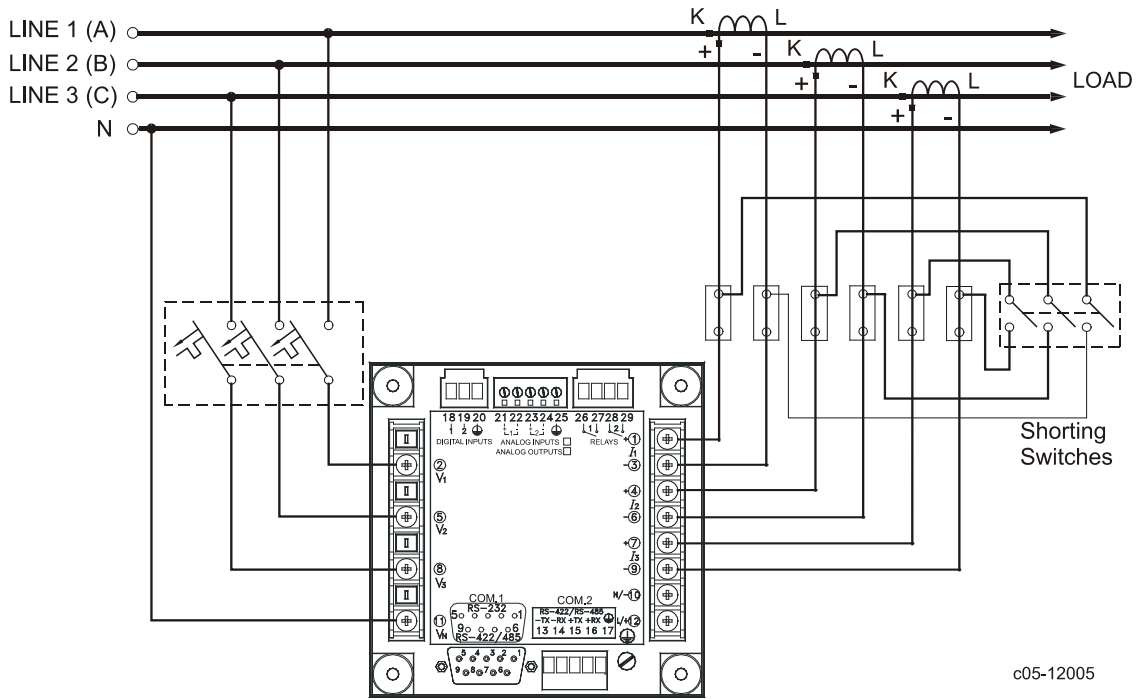
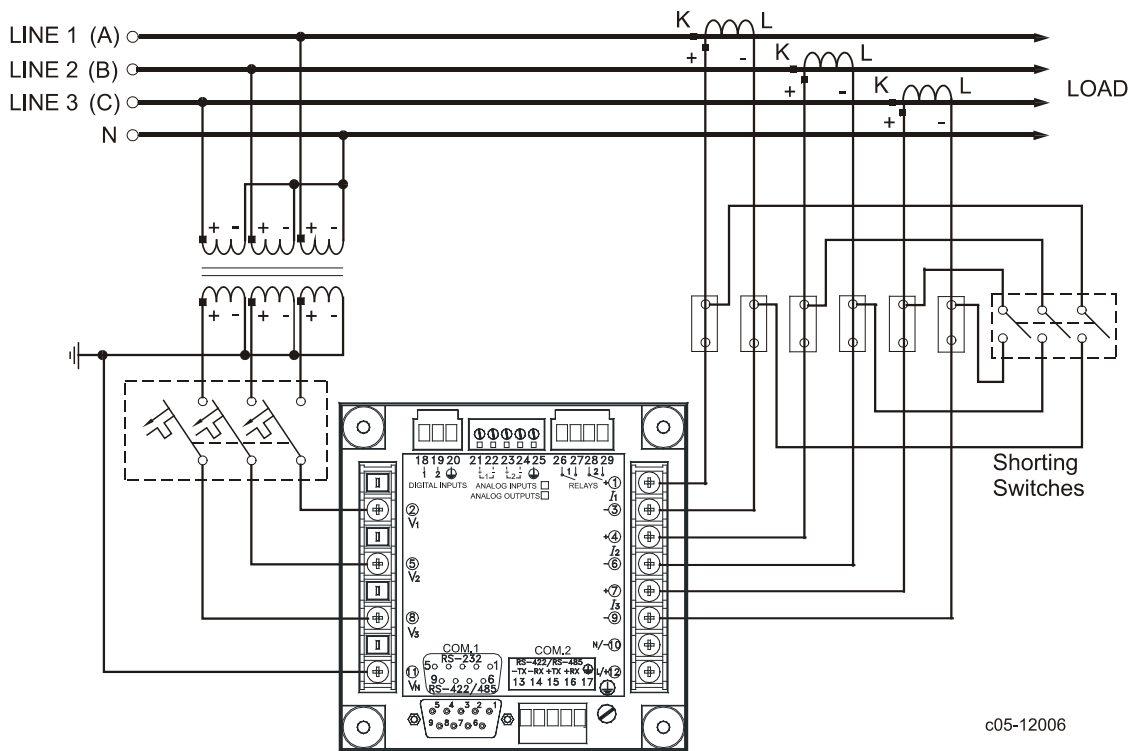

Figure 2-17 3-Wire 2-Element Direct Connection Using 2 CTs.
Wiring Mode = 3dir2



c05-12005

**Figure 2-18 4-Wire Wye 3-Element Direct Connection Using 3 CTs.
Wiring Mode = 4LL3 or 4Ln3**



c05-12006

**Figure 2-19 4-Wire Wye 3-Element Connection Using 3 PTs, 3 CTs.
Wiring Mode = 4LL3 or 4Ln3**

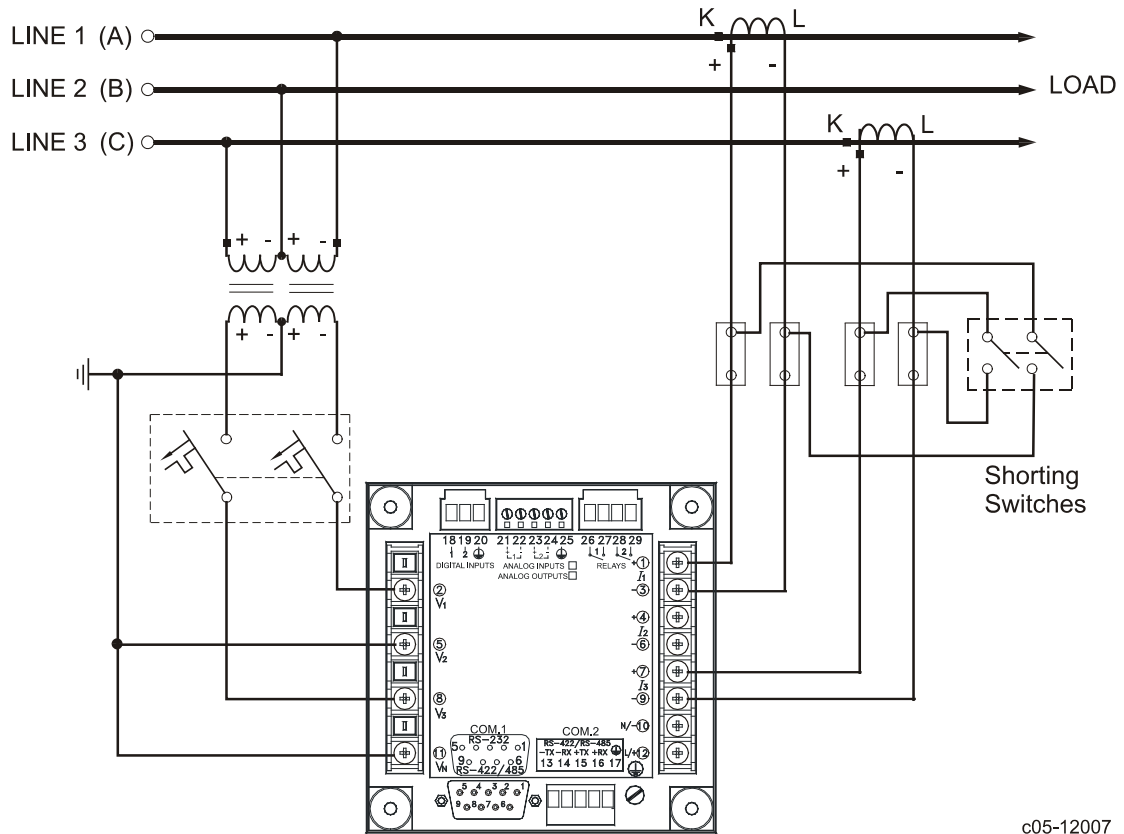

c05-12007

**Figure 2-20 3-Wire 2-Element Open Delta Connection Using 2 PTs, 2 CTs.
Wiring Mode = 3OP2**

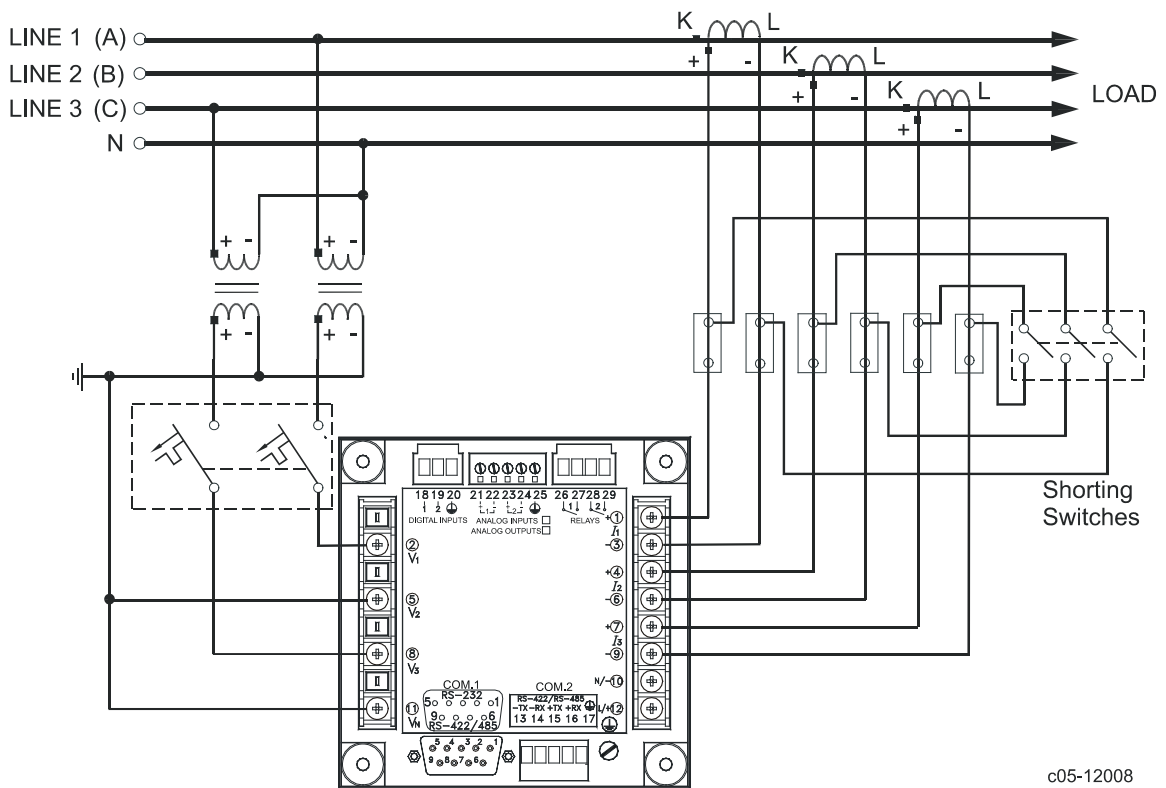

c05-12008

**Figure 2-21 4-Wire Wye 2½-Element Connection Using 2 PTs, 3 CTs.
Wiring Mode = 3LL3 or 3Ln3**

This configuration provides accurate power measurements only if the voltages are balanced.

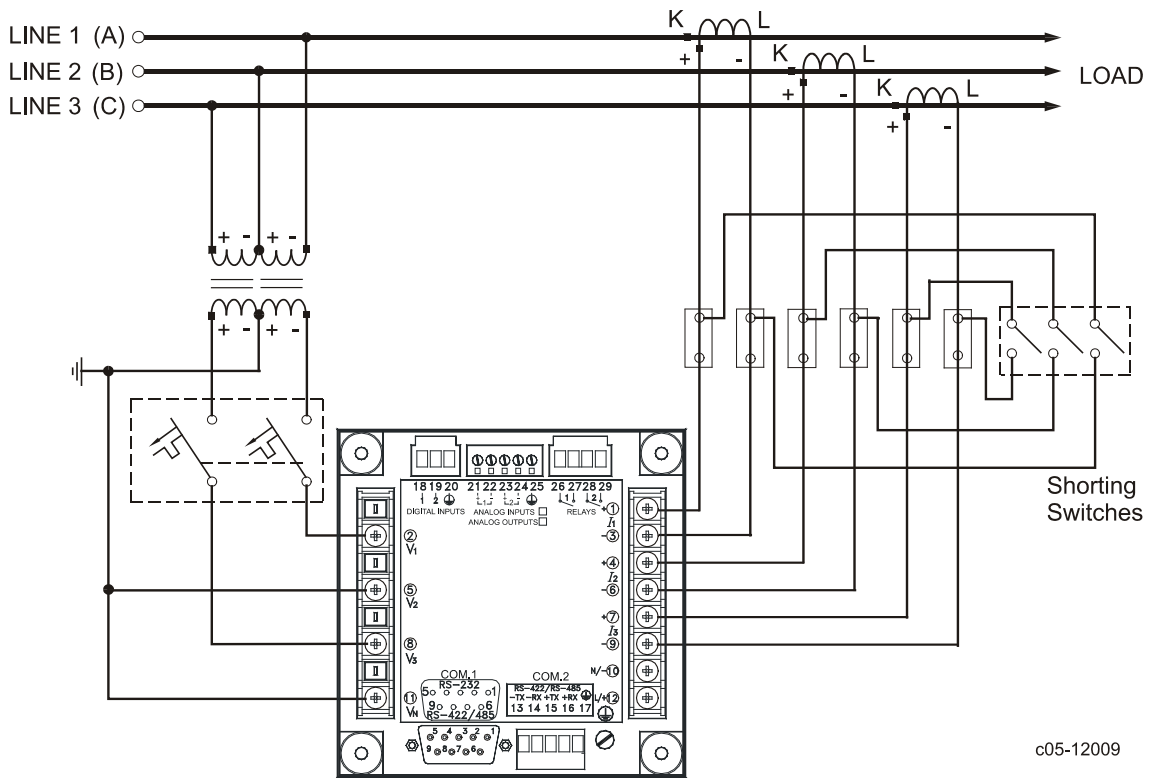

c05-12009

**Figure 2-22 3-Wire Open 2½-Element Delta Connection Using 2 PTs, 3 CTs.
Wiring Mode = 3OP3**

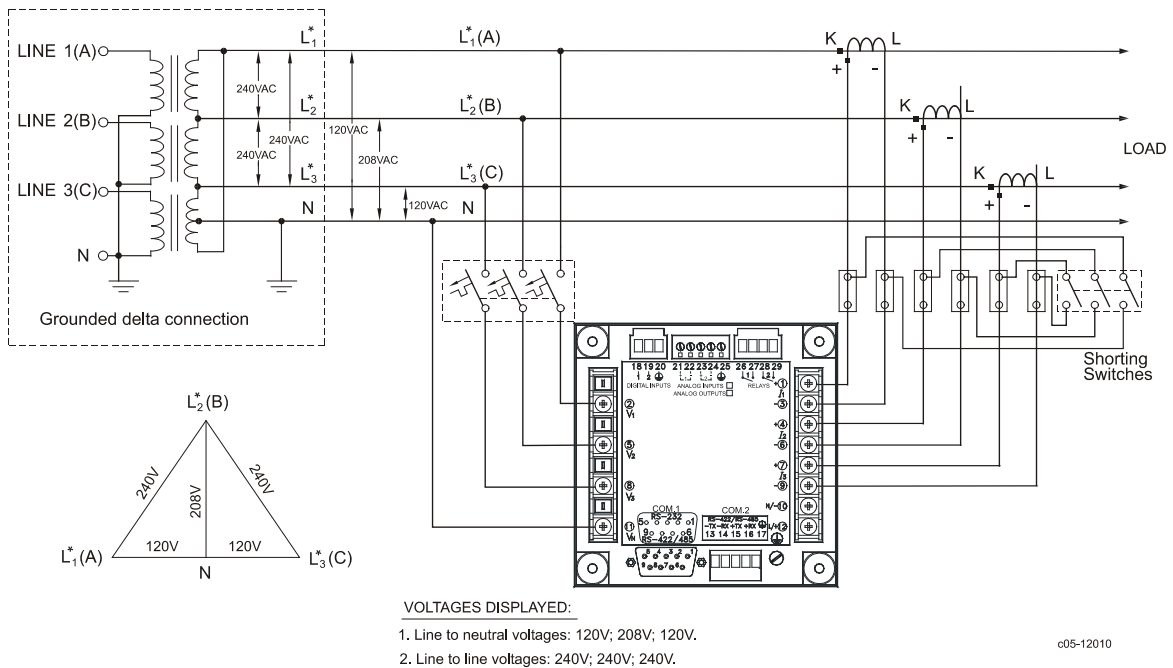

c05-12010

**Figure 2-23 4-Wire 3-Element Delta Direct Connection Using 3 CTs.
Wiring Mode = 4LL3 or 4Ln3**

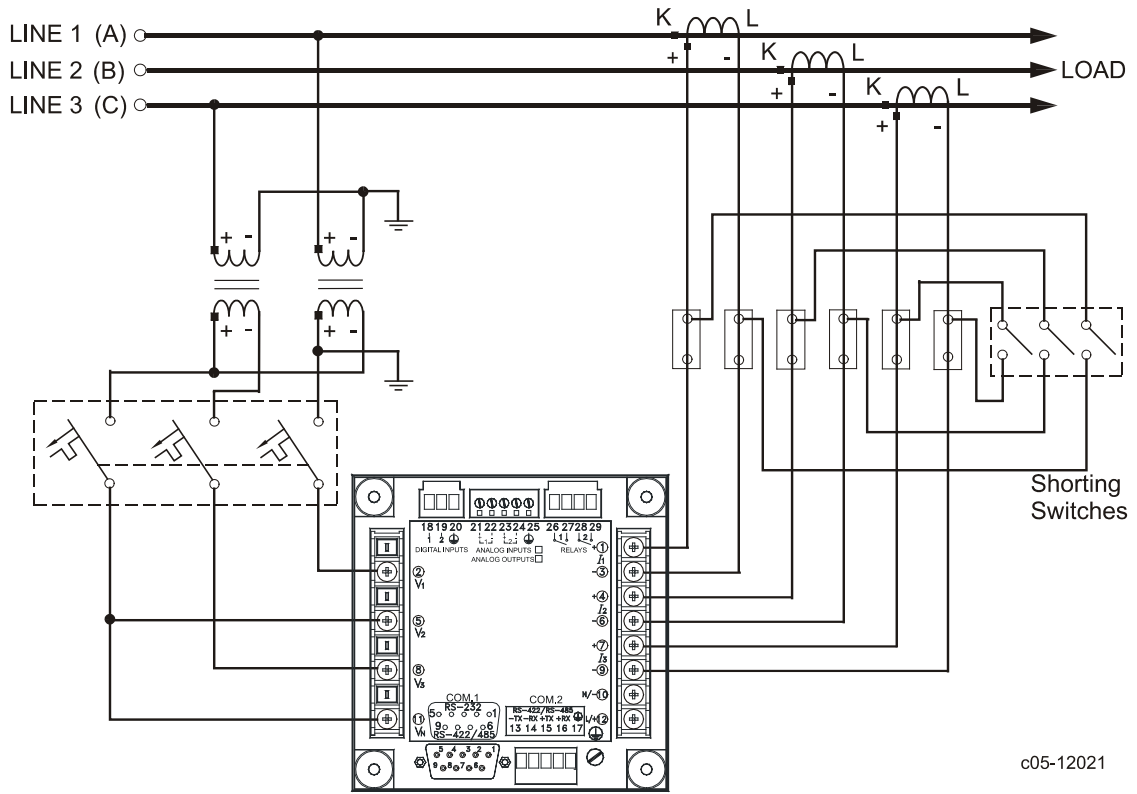

c05-12021

**Figure 2-24 3-Wire 2½-Element Broken Delta Connection Using 2 PTs, 3 CTs.
Wiring Mode = 3bLn3 or 3bLL3**

I/O Connections

For I/O ratings, see “Technical Specifications” in Appendix A.

Relay Outputs

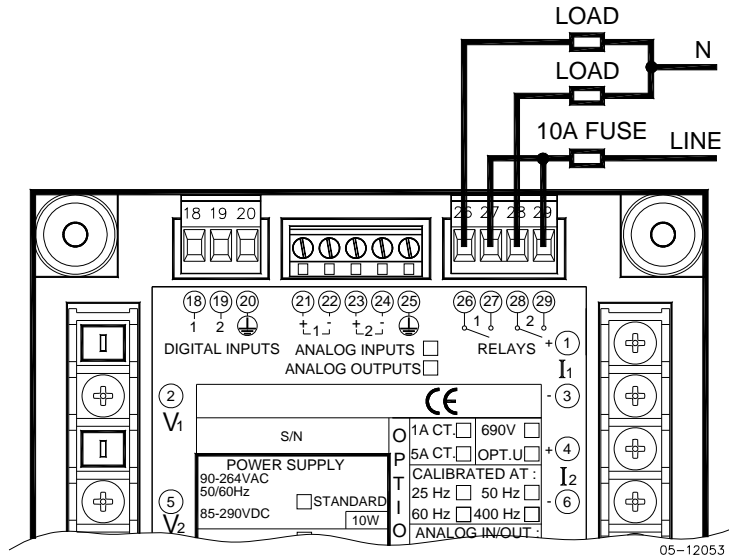

Figure 2-25 Relay Output Connection

Digital Inputs

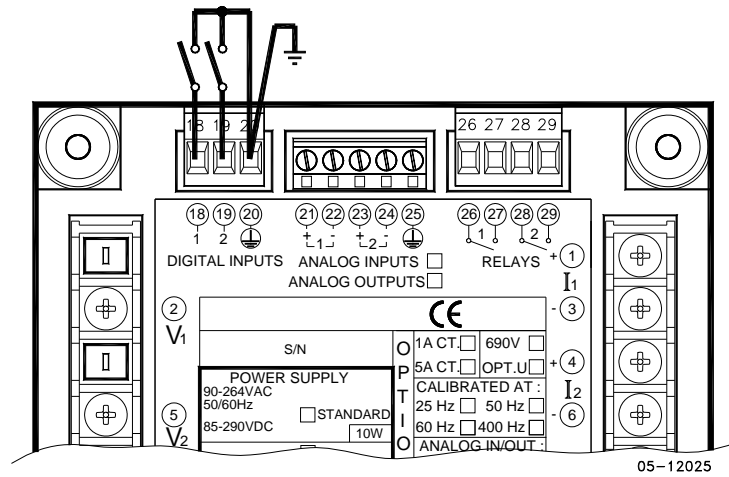

Figure 2-26 Digital Input Connection

Analog Outputs

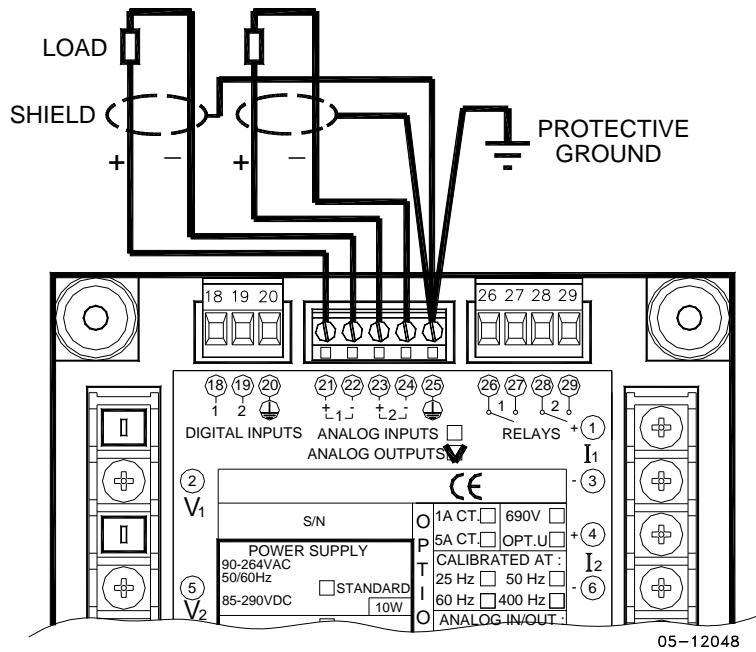

Figure 2-27 Analog Output Connection

Maximum current loop load:

- 510 Ohm for 0-20 mA and 4-20 mA options
- 5 kOhm for 0-1 mA and ±1 mA options

Analog Inputs

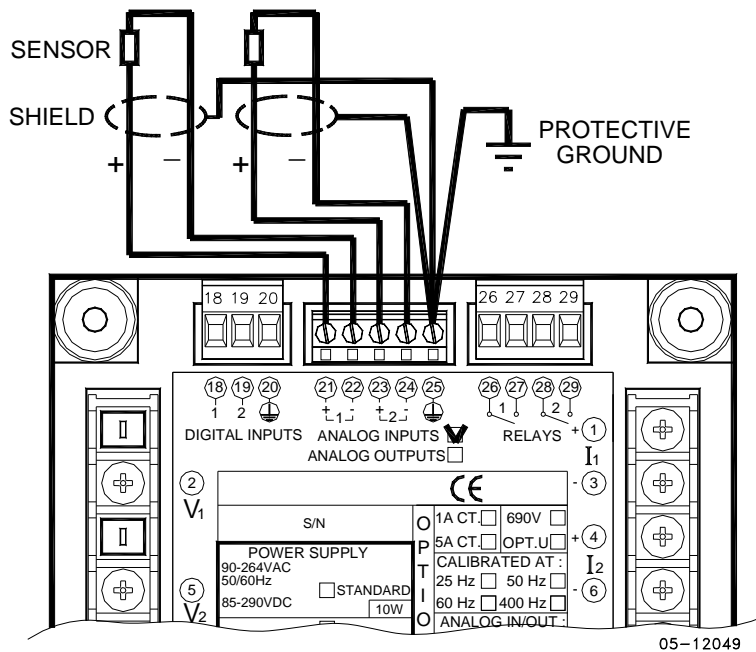

Figure 2-28 Analog Input Connection

Communications Connections

Several communication options are available for the PM172:

COM1 (check the label on the back of your meter):

- RS-232/RS-422/RS-485
- 56K Dial-up modem
- Ethernet 10/100BaseT
- Profibus DP

COM2:

- RS-422/RS-485

The RS-232/RS-422/RS-485 port is a standard port for COM1. Other options are ordered separately. Connections to the Ethernet RJ45 connector and to the telephone RJ11 connector are made through a cable adaptor provided with your meter (if ordered).

A full description of the communication protocols is found in the PM172 protocol guides provided with your meter.

COM1 RS-232 Connection

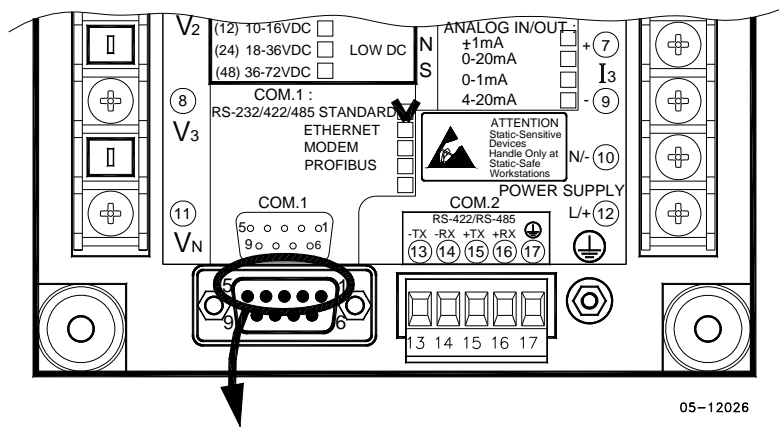

Connector 9-pin D-type female:

| Pin | Signal |
|-----|----------------------|
| 1 | RS-232 RTS |
| 2 | RS-232 RxD |
| 3 | RS-232 TxD |
| 4 | RS-232 CTS |
| 5 | RS-232 Signal ground |

PM172
RS232
MALE CON.

IBM PC/COMPATIBLE
25-PIN DB25
FEMALE CONNECTOR

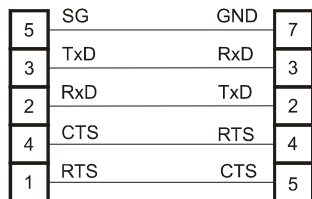

c04-01004

PM172
RS-232
MALE CON.

IBM PC/COMPATIBLE
9-PIN DB9
FEMALE CONNECTOR

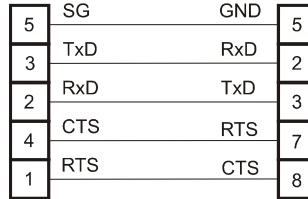

c04-01005

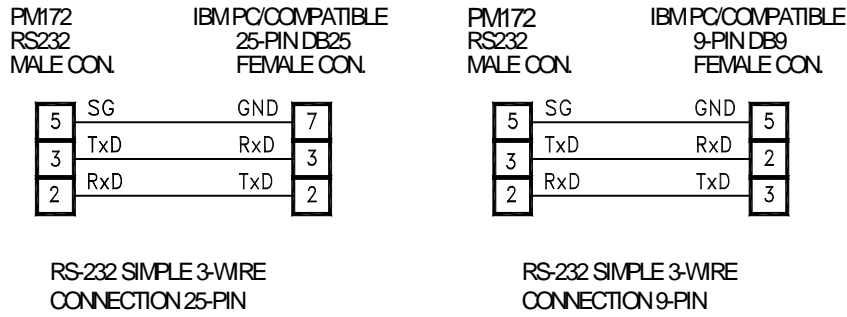

05-08004-5A

Figure 2-29 COM1: RS-232 Cable Drawings

COM1 RS-422/485 Connection

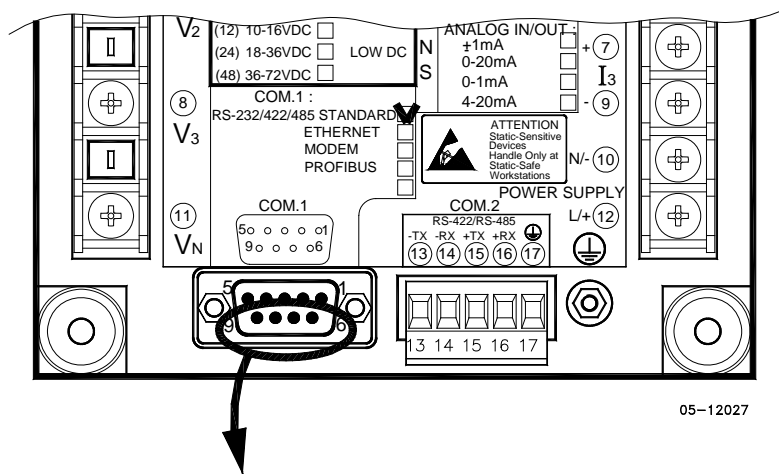

05-12027

Connector 9-pin D-type female:

| Pin | Signal |
|-----|-----------------|
| 6 | RS-422/485 +RxD |
| 7 | RS-422/485 +TxD |
| 8 | RS-422/485 -TxD |
| 9 | RS-422/485 -RxD |

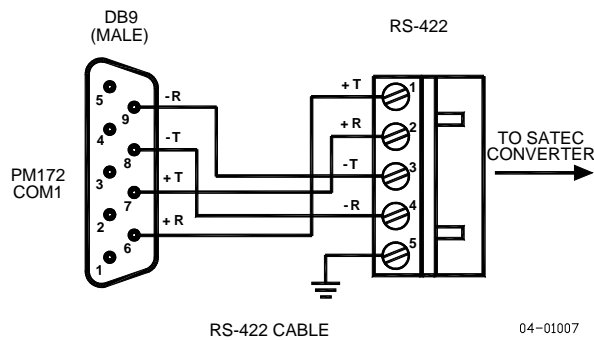

04-01007

Figure 2-30 COM1: Connection to the RS-422/485-RS-232 Converter

COM1 Dial Up Modem Connection

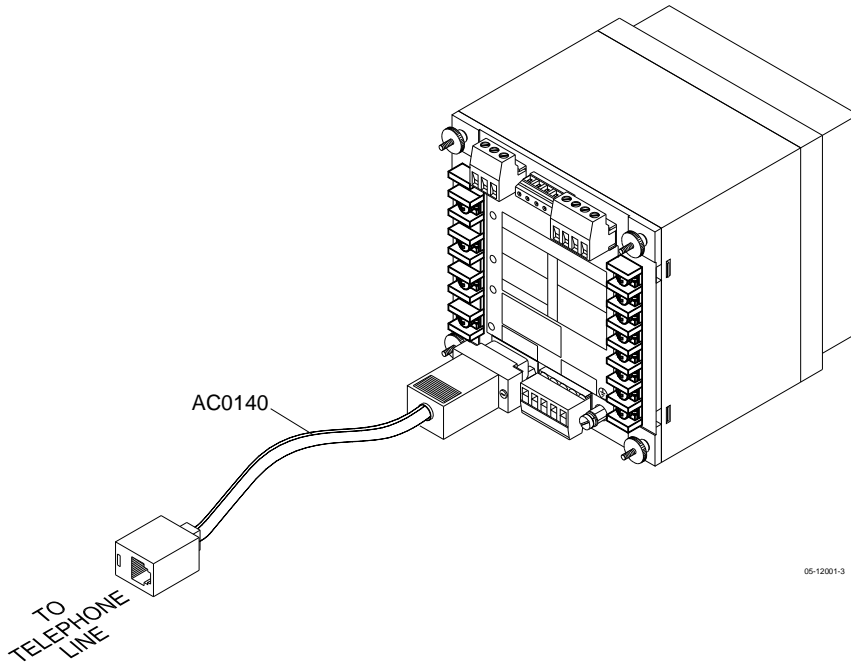

05-12001-3

Figure 2-31 COM1: Telephone Line Connection

Connector 9-pin D-type female:

| Pin | Signal |
|-----|--------|
| 6 | Ring |
| 8 | Tip |

COM1 Ethernet Connection

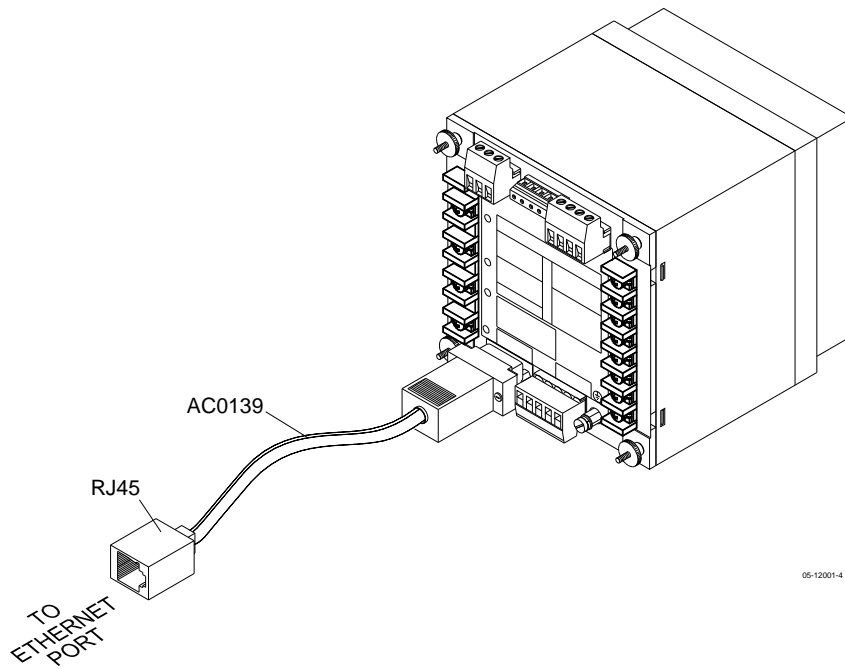

05-12001-4

Figure 2-32 COM1: Ethernet Connection

Connector 9-pin D-type female:

| Pin | Signal |
|-----|--------|
| 6 | +Rx |
| 7 | +Tx |
| 8 | -Tx |
| 9 | -Rx |

COM1 Profibus Connection

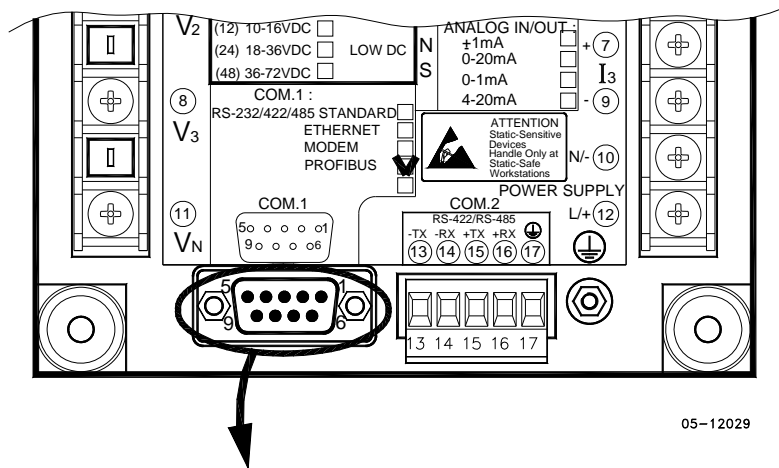

Connector 9-pin D-type female:

| Pin | Signal |
|-----|--------------------------------|
| 1 | N/C |
| 2 | N/C |
| 3 | B-Line, Positive RS485 RxD/TxD |
| 4 | RTS, Request To Send |
| 5 | GND BUS |
| 6 | +5V BUS |
| 7 | N/C |
| 8 | A-Line, Negative RS485 RxD/TxD |
| 9 | N/C |

COM2 RS-422/485 Connection

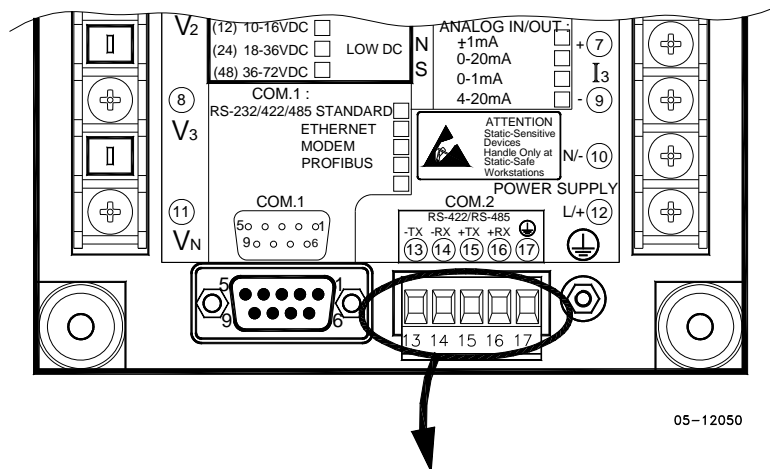

Connector removable, captured-wire, 5 terminals:

| Terminal | Signal |
|----------|--------|
| 13 | -TxD |
| 14 | -RxD |
| 15 | +TxD |
| 16 | +RxD |
| 17 | Ground |

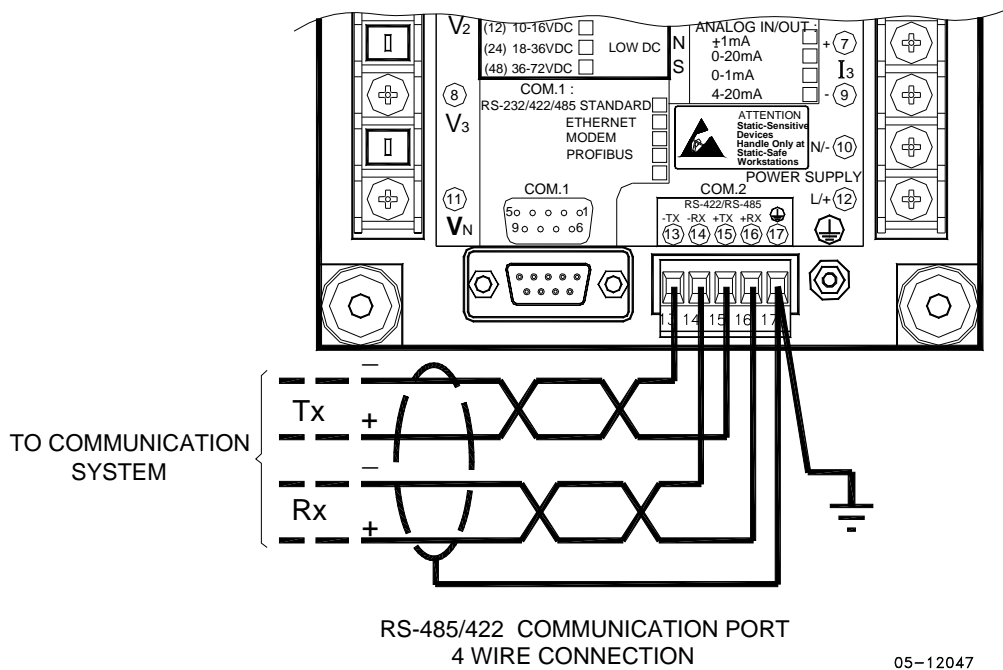

RS-485/422 COMMUNICATION PORT
4 WIRE CONNECTION

05-12047

Figure 2-33 COM2: RS-422/485 4 Wire Connection

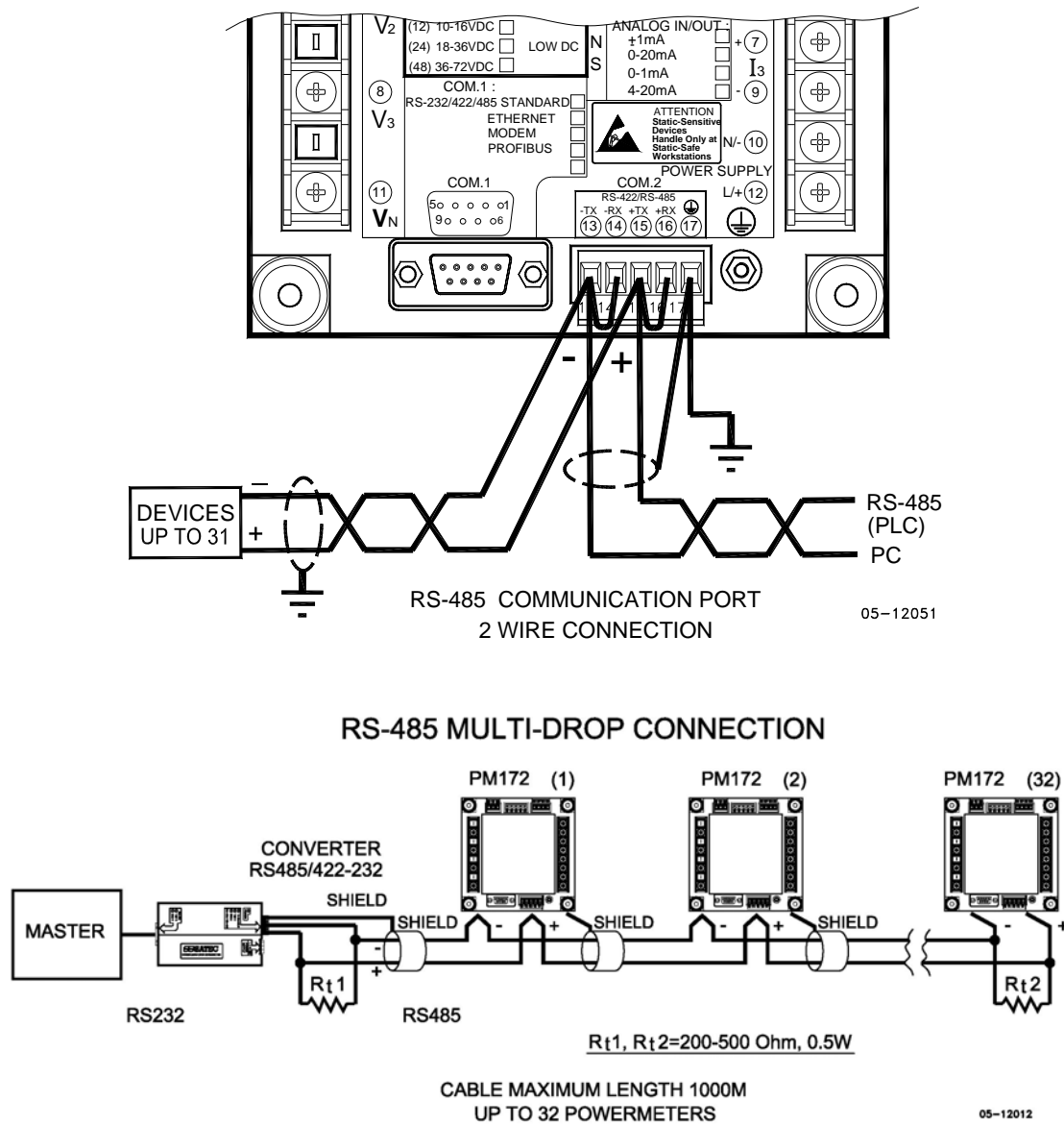
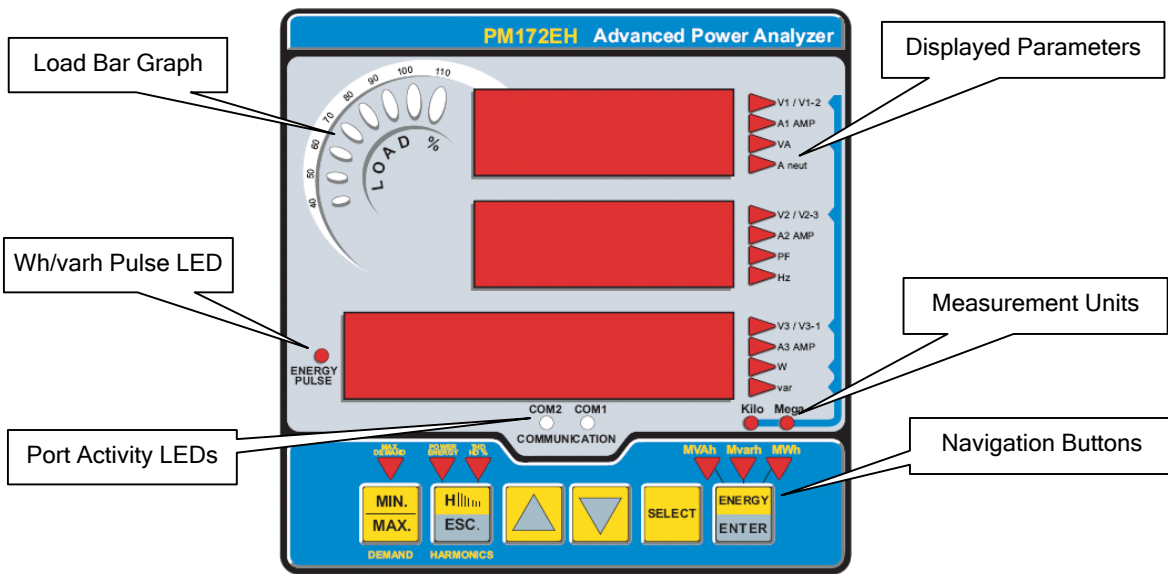
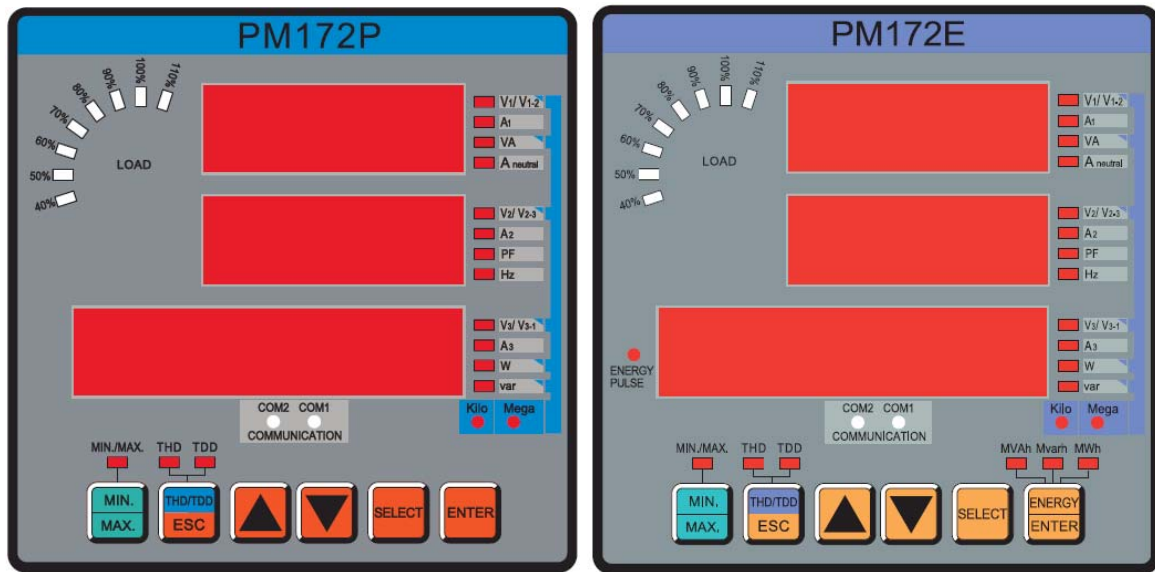

Figure 2-34 COM2: RS-485 2 Wire Connection

Chapter 3 Display Operations



Indicators and Controls

Display Diagnostics

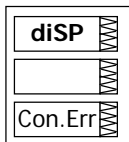

The display may indicate a connection error as shown on the left picture if it fails to establish a connection with the meter. Check the connection between the display module and the meter body. If the error message is still displayed, contact your local distributor.

Numeric LED Display

The meter has a simple user interface that allows you to view numerous measurement parameters by scrolling through different display pages. The

numeric LED display shows up to three parameters at a time. Small rectangular or triangular LEDs at right and below the display indicate the displayed parameters and their measurement units.

The display layout may change depending on the meter type and mode of operation. There are three modes of display operation: data display, status display, and programming mode display.

Load Bar Graph

The load bar graph displays the amount, in percent (40% to 110%), of the present current load with respect to user-defined nominal load current. The reference nominal current can be set up in amps through the Display Setup menu. If it is set to 0 (default), the current load is referenced to the specified CT primary current.

Energy Pulse LED

The PM172E and PM172EH have a red “Energy Pulse” LED. It flashes at a constant rate when a load is applied to the meter. There are two modes of LED operation: normal and test. In normal mode, the LED pulses indicate imported Wh at a rate of 1,000 pulses per kWh in secondary units. In test mode, the LED pulses indicate either imported Wh, or imported (inductive) varh at a rate of 10,000 pulses per kWh/kvarh. The energy test mode can be enabled through the Display Setup menu. When in test mode, the energy and demand accumulators do not account for consumed energy.

Port Activity LEDs

The meter has two yellow LEDs “COM1” and “COM2”, which indicate activity on the two communication ports. The port’s LED flashes when the port is receiving or transmitting data. With the Ethernet or Profibus option, the “COM1” LED flashes constantly regardless of the port activity.

When the display module is connected remotely through a 3-wire RS-485 interface, the “COM1” LED indicates the display port activity, while the “COM2” LED is not operational.

Navigation Buttons

The PM172 is provided with six push buttons that are normally used to navigate between different measurement displays. In programming mode, the buttons access the device setup menus and the default factory-set device settings can be changed.

Data Display

In data mode, the display is normally updated once per second; you can adjust the display update rate via the Display Setup menu.

Display Features

Measurement Units

Currents are always displayed in amperes with two decimal places.

Measurement units for voltage and power depend on the connection scheme of the meter:

- When direct wiring is used, voltages are displayed in volts with one decimal place, and power in kilowatts with three decimal places.

- When wiring via PT is used, for the PT ratio up to and including 4.0, voltages are displayed in volts, and power in whole kilowatts.
- For the PT ratio above 4.0, voltages are displayed in kilovolts, and power in megawatts with three decimal places.

The small round “Kilo” and “Mega” LEDs light up showing the appropriate measurement units for a displayed page.

Primary and Secondary Volts

Volts can be displayed in primary (default) or secondary units. The volts display mode can be changed through the Display Setup menu.

Phase Power Readings

In configurations with the neutral wire, in addition to total three-phase powers, the meter can show per-phase power readings. By default, they are disabled. See Display Setup on how to enable per-phase power readings in your meter.

Fundamental Component

The meter can display total power factor and active power for the fundamental component if it is enabled through the Display Setup menu. Whenever phase power readings are allowed, the PM172 also displays per-phase power factor and active power for the fundamental component.

Auto Return

If no buttons are pressed for 30 seconds while the display Auto Return option is enabled, the display automatically returns to the main screen from any other measurement display or programming mode.

The Auto Return option can be enabled through the Display Setup menu

Auto Scroll

If no buttons are pressed for 30 seconds while in the common measurements display, and the Auto Scroll option is enabled in the meter, the display automatically scrolls through all available pages. The scroll interval can be adjusted through the Display Setup menu.

To stop auto scrolling, press briefly the SCROLL button.

Navigation Buttons



In Data Display mode, the navigation buttons function as follows.

The **MIN/MAX** button switches to the Min/Max - Maximum Demands display pages. When briefly pressed again, it switches back to the common measurements display.

The **THD/TDD** button in the PM172P and PM172E switches to the Total Harmonics display. The similar **H/ESC** button in the PM172EH switches between different harmonic displays: Total Harmonics, Individual Harmonics, Harmonic Powers, and Harmonic Energies. When briefly pressed once again, it switches back to the common measurements display

The **UP** and **DOWN** arrow buttons, labeled by arrowheads, scroll forwards and backwards through the display pages. Pressed briefly, they move one page forward or backward. If you hold down the button, the display pages are scrolled at rate of a twice per second.

Pressing both the UP and DOWN arrow buttons together returns to the first page within the current display.

The **SELECT** button operates once it's released. The button has two functions:

- When pressed briefly, it switches to programming mode.
- When pressed together with the ENTER button for more than 5 seconds, it resets Min/Max records, maximum demands, or energies depending on the currently displayed page. If the meter is password protected and a simple reset of data from the display is not allowed, the action has no effect.

The **ENERGY** button switches to the Energy display in the PM172E and PM172EH. In the PM172P, the button is not operational. If TOU registers are configured in the meter, you can repeatedly press this button to scroll through all available TOU registers. When briefly pressed once again, it switches back to the common measurements display

Simple Reset of Accumulated Data

When the meter is not password protected, or the simple reset of data is allowed from the display regardless of the security setting (see "Display Setup"), the meter allows the simple "two-button" reset of the Min/Max registers, maximum demands, energies, and counters from the data display mode without entering the reset menu:

1. Select a display page where the data you want to reset is displayed:
 - Min/Max log - select a Min/Max page from the Min/Max Display.
 - Ampere and volt maximum demands - select the ampere or volt maximum demand page from the Min/Max Display.
 - Power maximum demands - select the power maximum demand page from the Min/Max Display.
 - Total and phase energies - select a total energy, or phase energy page from the Energy Display.
 - Counters - select a counter page from the Status Display
2. While holding the SELECT button, press and hold the ENTER button for about 5 seconds. The displayed data is reset to zero.

Common Measurements Display

Scroll through pages with the UP and DOWN arrow buttons.



| Common Measurements (Main Display) | | |
|------------------------------------|-------------------------------|---|
| 1 | V12 V23 V31 L | Line-to-line volts |
| 2 | V1 V2 V3 P | Line-to-neutral volts (in 4LN3, 3LN3, 3BLN3 configurations) |
| 3 | I1 I2 I3 | Amps |
| 4 | kVA/MVA PF kW/MW | Total VA Total PF Total W |
| 5 | In Hz kvar/Mvar | Neutral current Frequency Total var |
| 6 | Ph.L1 PF kW/MW | Phase L1 powers (if enabled) |

| Common Measurements (Main Display) | | |
|------------------------------------|--------------------------------------|---|
| 7 | kVA/MVA Ph.L1 kvar/Mvar | Phase L1 powers (if enabled) |
| 8 | Ph.L2 PF kW/MW | Phase L2 powers (if enabled) |
| 9 | kVA/MVA Ph.L2 kvar/Mvar | Phase L2 powers (if enabled) |
| 10 | Ph.L3 PF kW/MW | Phase L3 powers (if enabled) |
| 11 | kVA/MVA Ph.L3 kvar/Mvar | Phase L3 powers (if enabled) |
| 12 | H01 PF kW/MW | Fundamental total powers (if enabled) |
| 13 | H1.L1 PF kW/MW | Fundamental phase L1 powers (if enabled) |
| 14 | H1.L2 PF kW/MW | Fundamental phase L2 powers (if enabled) |
| 15 | H1.L3 PF kW/MW | Fundamental phase L3 powers (if enabled) |
| 16 | An.In AI1 AI2 | Analog inputs (optional) |

Min/Max and Max. Demands Display

Press the MIN/MAX button. The MIN/MAX LED, or MAX DEMAND LED in the PM172EH, is illuminated when in the MIN/MAX display. Use the UP and DOWN arrow buttons to scroll through the Min/Max and Max. Demand pages.

Note that volts readings are line-to-neutral in 4LN3, 3LN3 and 3BLN3 wiring modes, and line-to-line in other modes.

| Min/Max and Maximum Demands | | |
|-----------------------------|--------------------------------------|--|
| 1 | V1/V12 V2/V23 Lo V3/V31 | Minimum volts |
| 2 | I1 I2 Lo I3 | Minimum amps |
| 3 | kVA/MVA PF Lo kW/MW | Minimum total VA Minimum total PF (absolute) Minimum total W |
| 4 | In Hz Lo kvar/Mvar | Minimum neutral current Minimum frequency Minimum total var |
| 5 | V1/V12 V2/V23 Hi V3/V31 | Minimum volts |
| 6 | I1 I2 Hi I3 | Maximum amps |
| 7 | kVA/MVA PF Hi kW/MW | Maximum total VA Maximum total PF (absolute) Maximum total W |
| 8 | In Hz Hi kvar/Mvar | Maximum neutral current Maximum frequency Maximum total var |



| Min/Max and Maximum Demands | | |
|-----------------------------|-----------|--|
| 9 | Hd | V1/V12 V2/V23 V3/V31 Maximum volt demands |
| 10 | Hd | I1 I2 I3 Maximum ampere demands |
| 11 | Hd | kVA/MVA PF kW/MW Maximum VA demand PF at maximum VA demand Maximum W demand |

Harmonics Display

Press the THD/TDD, or H/ESC in the PM172EH, button. The THD/TDD LED is illuminated. In the PM172EH, press the button again to move to the individual harmonics, or to the harmonic power and energy displays. Use the UP and DOWN arrow buttons to scroll through harmonics measurements.

Note that voltage harmonics readings are line-to-neutral in the 4LN3, 3LN3, 3BLN3, 4LL3, 3LL3 and 3BLL3 wiring modes, and line-to-line in all other modes.



| Total Harmonics | | |
|-----------------|-------------|---|
| 1 | thd. | V1/V12 THD V2/V23 THD V3/V31 THD Voltage THD |
| 2 | thd. | I1 THD I2 THD I3 THD Current THD |
| 3 | tdd. | I1 TDD I2 TDD I3 TDD Current TDD |
| 4 | HF | I1 K-Factor I2 K-Factor I3 K-Factor Current K-Factor |









| Individual Voltage Harmonics | | |
|------------------------------|------------|--|
| 1 | 02H | V1/V12 HD% V2/V23 HD% V3/V31 HD% Order 2 harmonic distortion |
| 2 | 03H | V1/V12 HD% V2/V23 HD% V3/V31 HD% Order 3 harmonic distortion |
| 39 | 40H | V1/V12 HD% V2/V23 HD% V3/V31 HD% Order 40 harmonic distortion |



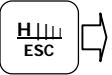



| Individual Current Harmonics | | |
|------------------------------|------------|--|
| 1 | 02H | I1 HD% I2 HD% I3 HD% Order 2 harmonic distortion |
| 2 | 03H | I1 HD% I2 HD% I3 HD% Order 3 harmonic distortion |
| 39 | 40H | I1 HD% I2 HD% I3 HD% Order 40 harmonic distortion |





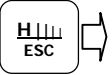

| Harmonic Powers | | |
|-----------------|--|------------------------------|
| 1 | | kVA/MVA Total harmonic VA |
| | | kW/MW Total harmonic W |

| Harmonic Energies | | |
|-------------------|------------------------------------|--------------------|
| 1 | Ac.En. IP. MWh | Harmonic Wh import |
| 2 | Ac.En. EP. MWh | Harmonic Wh export |
| 3 | AP.En. MVAh | Harmonic VAh |

Energy Display

Press the ENERGY button. The MVAh, Mvarh, or MWh LED is illuminated. If TOU registers are configured in the meter, press the button again to scroll through all active TOU registers. Use the UP and DOWN arrow buttons to scroll through energy pages.

Along with total energies, per phase energy accumulators are displayed if phase energy calculation is enabled in the Device Options menu.

| Total and Phase Energies | | |
|--------------------------|---|----------------------|
| 1 | Ac.En. IP. MWh | Total Wh import |
| 2 | rE.En. IP. Mvarh | Total varh import |
| 3 | AP.En. MVAh | Total VAh |
| 4 | Ac.En. EP. MWh | Total Wh export |
| 5 | rE.En. EP. Mvarh | Total varh export |
| 6 | Ac.En. IP.L1. MWh | Phase L1 Wh import |
| 7 | rE.En. IP.L1. Mvarh | Phase L1 varh import |
| 8 | AP.En. L1. MVAh | Phase L1 VAh |
| 9 | Ac.En. IP.L2. MWh | Phase L2 Wh import |
| 10 | rE.En. IP.L2. Mvarh | Phase L2 varh import |
| 11 | AP.En. L2. MVAh | Phase L2 VAh |
| 12 | Ac.En. IP.L3. MWh | Phase L3 Wh import |
| 13 | rE.En. IP.L3. Mvarh | Phase L3 varh import |
| 14 | AP.En. L3. MVAh | Phase L3 VAh |

| TOU Energy Register 1 | | |
|-----------------------|-------------------------------------|------------------|
| 1 | rEG.1 trF.1 MWh | Tariff 1 reading |
| 2 | rEG.1 trF.2 MWh | Tariff 1 reading |
| ... | | |
| 8 | rEG.1 trF.8 MWh | Tariff 8 reading |

| TOU Energy Register 8 | | |
|-----------------------|-------------------------------------|------------------|
| 1 | rEG.8 trF.1 MWh | Tariff 1 reading |
| 2 | rEG.8 trF.2 MWh | Tariff 1 reading |
| ... | | |
| 8 | rEG.8 trF.8 MWh | Tariff 8 reading |

Status Display

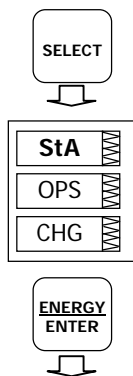

The meter has separate status information pages accessible through the primary device menu. The Status Display shows rarely used information that is especially helpful when connecting the meter inputs and outputs to external equipment. For information on navigating in the menus, see “Using the Menus”.

To enter the Status Display:

1. From the Data Display, press the SELECT button to enter the primary device menu. The “StA” window is highlighted.
2. Press ENTER to enter the Status Display. Use the UP and DOWN arrow buttons to scroll through the status pages.

To exit the Status Display:

1. Press ESC to return to the primary device menu.
2. Press ESC to return to the Data display.

| Status Display | | |
|----------------|---|--|
| 1 | PhS rot POS/nEG/Err | Phase rotation order |
| 2 | V1 angle V2 angle AG. V3 angle | Voltage angles ($\pm 180^\circ$, referenced to V1) |
| 3 | I1 angle I2 angle AG. I3 angle | Current angles ($\pm 180^\circ$, referenced to V1) |
| 4 | U.Unb V% unb | Voltage unbalance, percent |
| 5 | C.Unb I% unb | Current unbalance, percent |
| 6 | rEL 1.2. 00 | Relay status |
| 7 | St.In 1.2. 00 | Status inputs |

| Status Display | | |
|----------------|----------------------------|------------------------------------|
| 8 | Cnt.1 Counter #1 | |
| 9 | Cnt.2 Counter #2 | |
| 10 | Cnt.3 Counter #3 | |
| 11 | Cnt.4 Counter #4 | |
| 12 | batt nor/Lo | Backup battery status (Normal/Low) |

Using the Menus

Navigation Buttons



The PM172 has a menu-driven setup. To enter the menus, press and release the SELECT button.

The **SELECT** button selects (highlights) an active window in which you can select or change a desired menu item. The button operates once it's briefly pressed and released.

The **UP** and **DOWN** arrow buttons scroll through menu items in the highlighted window forwards and backwards, and allow changing a highlighted item when entering numbers.

The **ENTER** button confirms the selection of a menu item or a number in the highlighted window, thus allowing to enter a submenu or to store a changed item.

The **ESC** button is "Escape" leaving the highlighted item unchanged or returning to the upper level menu.

Selecting Menus

To access the meter menus, press and release the SELECT button. The primary meter menu is open as shown below. The menu has three entries:

- StA - Status Display entry (see "Status Display" above)
- OPS - Main setup menu entry allowing to review setup options
- CHG - Main setup menu entry allowing to change setups

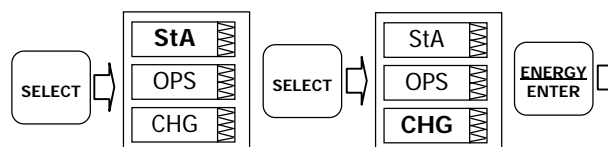

To enter the Status Display:

1. If the StA window is not highlighted, use the SELECT button to activate it.
2. Press the ENTER button to enter the Status Display

To review the meter setup options:

1. Press the SELECT button to activate the OPS window.
2. Press the ENTER button to enter the main menu.

To change the meter setup, or to clear the accumulated values:

1. Press the SELECT button to activate the CHG window.
2. Press the ENTER button to enter the main menu.

Entering the Password

The Setup Change menu can be secured by a four-digit user password. The meter is primarily shipped with the password preset to 0 and password protection disabled. You can change the password and enable password protection through the Access Control menu (see Meter Security).

If authorization is not required, just press the ENTER button to move to the Main menu; otherwise you should enter a correct password to be authorized to access the meter setup.

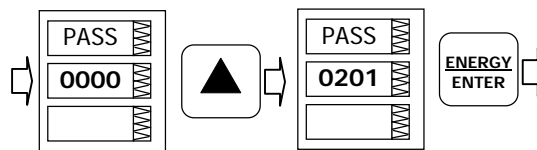

To enter the password:

1. Adjust the first digit with the UP and DOWN arrow buttons.
2. Press the SELECT button to advance to the next digit.
3. Adjust the remaining password digits in the same manner.
4. Press ENTER to confirm the password.

If the password entered is correct, you move to the Main menu, otherwise you return to the previous menu.

Selecting the OPS or CHG entry moves you to the Main menu that is represented by two entries: the upper window displays a secondary menu list, while the bottom item is an assisting exit window.

Selecting a Menu Entry

To select a menu entry from the menu list:

1. Highlight the upper item by pressing the SELECT button.

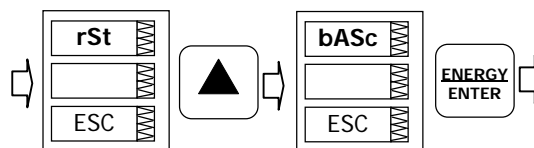

2. Scroll through the menu list by pressing briefly the UP and DOWN arrow buttons until the desired menu entry appears.
3. Press the ENTER button.

Viewing and Changing Setup Items

A second level menu normally consists of three items: the upper static window indicates the menu name, while the middle window represents a list of setup parameters you can scroll through, and the lower item shows the present parameter value.

To select a parameter you want to view or change:

1. Highlight the middle window by pressing the SELECT button.

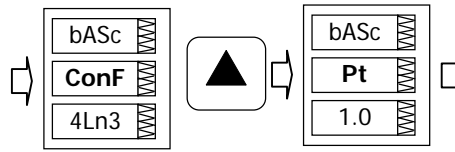

2. Scroll through the parameter list with the UP and DOWN buttons until the desired parameter name appears.

To change the selected parameter:

1. Press the SELECT button to highlight the lower item.

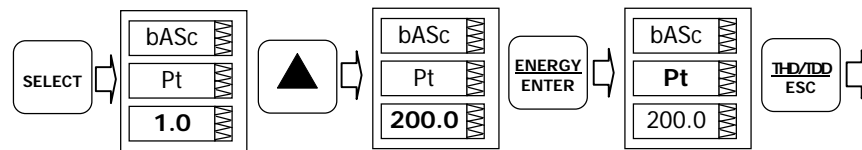

2. If a number represents the parameter, adjust it to the desired value with the UP and DOWN arrow buttons. When briefly pressed, the button increments or decrements the number by one. When the button is pressed continuously, the number is changed approximately twice per second.
3. If a name represents the parameter, select the desired option with the UP and DOWN arrow buttons.
4. To store your new selection, press the ENTER button.
5. To leave the parameter unchanged, press the ESC button.

You will return to the parameter list to select another parameter or return to the main menu.

To exit the menu, press ESC.

Menu Operations

Basic Device Settings

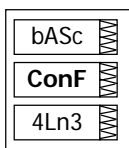

This menu allows you to configure the basic meter settings that define the general operating characteristics of the device. To enter the menu, select the "baSc" entry from the main menu, and then press the ENTER button.

To select a setup option:

1. Press the SELECT button to activate the middle window.
2. Use the UP and DOWN arrow buttons to scroll to the desired option.

To change the option:

1. Press the SELECT button to activate the lower window.
2. Use the UP and DOWN arrow buttons to select the desired option.
3. Press ENTER to confirm your changes and to store your new setting, or press ESC to discard changes.

To exit the menu, press ESC.

The following table lists available options.

| Label | Parameter | Options | Default | Description |
|-------|---|---|---------|--|
| ConF | Wiring connection (configuration) mode | See "Basic Meter Setup" in Chapter 4 | 4Ln3 | The wiring connection of the device |
| Pt | PT ratio | 1.0-6500.0 | 1.0 | The phase potential transformer's primary to secondary ratio |
| Pt.F | PT Ratio multiplier | ×1, ×10 | ×1 | PT Ratio multiplication factor. Used in extra high voltage networks to accommodate the PT ratio for 500 kV and higher networks. |
| U.SEC | Nominal secondary voltage ^{EH} | 10-690 V | 120 V | The nominal secondary line-to-neutral or line-to-line voltage. Used as a reference voltage for the disturbance monitor. |
| Ct | CT primary current | 1-20,000 A | 5 A | The primary rating of the phase current transformer |
| d.P | Power block demand period ^E | 1, 2, 3, 5, 10, 15, 20, 30, 60 min, E=external sync | 15 min | The length of the demand period for power demand calculations. If the external synchronization is selected, a pulse front on the digital input DI1 denotes the start of the demand interval. |
| nd.P | The number of blocks in the sliding window ^E | 1-15 | 1 | The number of blocks to be averaged for sliding window demands |
| Ad.P | Ampere, volt and THD demand period | 0-1800 sec | 900 sec | The length of the demand period for ampere, volt and THD demand calculations |
| Freq | Nominal frequency | 50,60,25, 400 Hz | 60 Hz | The nominal line frequency |
| LoAd | Maximum demand load current | 0-20,000 A | 0 | The maximum demand load current (0 = CT primary) |

△ Always specify the wiring mode and transformer ratings prior to setting up setpoints and analog outputs.

△ The maximum value for the product of the phase CT primary current and PT ratio is 57,500,000. If the product is greater, power readings are zeroed.

Device Options

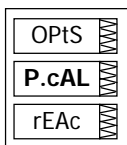

This menu allows you to change the user-configurable device options or put the meter into energy test mode. To enter the menu, select the "OPTS" entry from the Main menu, and then press the ENTER button.

To select a setup option:

1. Press the SELECT button to activate the middle window.
2. Use the UP and DOWN arrow buttons to scroll to the desired option.

To change the option:

1. Press the SELECT button to activate the lower window.
2. Use the UP and DOWN arrow buttons to select the desired option.
3. Press ENTER to confirm your changes and to store your new setting, or press ESC to discard changes.

To exit the menu, press ESC.

The following table lists available options.

| Label | Parameter | Options | Default | Description |
|-------|--------------------------------------|--|----------|--|
| P.cAL | Power calculation mode | rEAc (reactive power), nAct (non-active power) | Reactive | The method used for calculating reactive and apparent powers |
| roLL | Energy roll value ^E | 10.E4=10,000 10.E5=100,000 10.E6=1,000,000 10.E7=10,000,000 10.E8=100,000,000 10.E9=1,000,000,000 | 10.E9 | The value at which energy counters roll over to zero |
| Ph.En | Phase energy option ^E | diS = disabled En = enabled | Disabled | Enables phase energy calculations |
| Hr.En | Harmonic energy option ^{EH} | diS = disabled En = enabled | Disabled | Enables harmonic energy calculations |
| bAtt | Backup battery mode | OFF = switched OFF On = switched ON | OFF | Allows to conserve a battery while the meter is out of operation |
| tESt | Energy test mode ^E | OFF = disabled Ac.Ei = Wh pulses rE.Ei = varh pulses | Disabled | Setting this option puts the meter into the energy test mode |
| An.EP | Analog expander option ¹ | nonE = disabled 0-20 = 0-20 mA 4-20 = 4-20 mA 0-1 = 0-1 mA -1-1 = ±1 mA | Disabled | Enables outputs for the AX-8 analog expanders through port COM2. See "Analog Expander Setup" |
| C.Str | Starting Current, %FS | 0.1-2.0 | 0.1%FS | Specifies the low current measurement limit in percent of the full scale current (1A, 5A). Available in the PM172P/E V13.1.19 and later. |

¹ Do not enable the analog expander output if you do not have the analog expander connected to the meter, otherwise it will disturb the computer communications.

Transformer Correction

This menu is available in the PM172P/E with firmware V13.1.19 and later, or V13.71.12 and later.

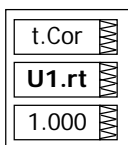

Transformer correction allows you to compensate ratio and phase angle inaccuracies of the user voltage and current instrument transformers. To enter the menu, select the "t.Cor" entry from the Main menu, and then press the ENTER button.

To select a setup option:

1. Press the SELECT button to activate the middle window.
2. Use the UP and DOWN arrow buttons to scroll to the desired option.

To change the option:

1. Press the SELECT button to activate the lower window.
2. Use the UP and DOWN arrow buttons to select the desired option.
3. Press ENTER to confirm your changes and to store your new setting, or press ESC to discard changes.

To exit the menu, press ESC.

The following table lists available options.

| Label | Parameter | Options | Default | Description |
|-------------------------|---|---|---------|--|
| U1.rt U2.rt U3.rt | V1-V3 voltage transformer ratio correction factor | 0.900 to 1.100 | 1.000 | The ratio of the true transformer ratio to the marked ratio. |
| U1.AG U2.AG U3.AG | V1-V3 transformer phase angle error, minutes | -600 to 600 (-2700 to 2700 with V13.7X.XX) | 0 | The phase displacement, in minutes, between the primary and secondary values. The phase angle of a voltage transformer is positive when the secondary value leads the primary value. |
| C1.rt C2.rt C3.rt | I1-I3 current transformer ratio correction factor | 0.900 to 1.100 | 1.000 | The ratio of the true transformer ratio to the marked ratio. |
| C1.AG C2.AC C3.AG | I1-I3 transformer phase angle error, minutes | -600 to 600 (-2700 to 2700 with V13.7X.XX) | 0 | The phase displacement, in minutes, between the primary and secondary values. The phase angle of a current transformer is positive when the secondary value leads the primary value. |

Communication Ports

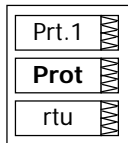

These two menus allow you to configure parameters for communication ports COM1 and COM2. To enter the menu, select “Prt.1” for COM1 or “Prt.2” for COM2 from the Main menu, and then press the ENTER button.

To select a setup option:

1. Press the SELECT button to activate the middle window.
2. Use the UP and DOWN arrow buttons to scroll to the desired option.

To change the option:

1. Press the SELECT button to activate the lower window.
2. Use the UP and DOWN arrow buttons to select the desired option.
3. Press ENTER to confirm your changes and to store your new setting, or press ESC to discard changes.

To exit the menu, press ESC.

The following tables list available port options.

COM1 Settings

| Label | Parameter | Options | Default | Description |
|-------|-----------------------------|---|----------------------|---|
| Prot | Communications protocol | ASCII = SATEC ASCII rtu = Modbus RTU ² dnP3 = DNP3 ² dtE = DTE PrFb = Profibus DP | Modbus RTU | The communications protocol supported by the port |
| rS | Port interface ¹ | 232 = RS-232 485 = RS-485 422 = RS-422 dial = Dial-up Modem Eth. = Ethernet PrFb = Profibus DP | Depends on the order | For non-serial interfaces - not changeable; automatically detected by the meter |

| Label | Parameter | Options | Default | Description |
|-------|----------------------------|---|----------------------|--|
| Addr | Device address | SATEC ASCII: 0-99 Modbus RTU: 1-247 DNP3: 0-65532 DTE: 1-65532 Profibus DP: 0-126 | 1 (126 for Profibus) | Device network address |
| bAud | Baud rate | 300-115200 bps | 19200 bps | The port baud rate |
| dAtA | Data format and parity | 7E, 8N, 8E | 8N | 7E data format should not be used with the Modbus RTU and DNP3 protocols |
| H.Sh | Handshaking (flow control) | nonE=no flow control SOFT=software (XON/XOFF) HARd=hardware (CTS) | None | |
| rtS | RTS mode | nonE = not used Forc = RTS is permanently asserted Ctrl = RTS is asserted during the transmission | None | |

¹ The meter automatically detects a replaceable communication module and does not allow you to change the interface, baud rate or data format for the Dial-up modem, and for the Ethernet or Profibus port.

² Selecting the DNP3 protocol on the Ethernet port launches the DNP3/TCP server along with the Modbus/TCP server allowing simultaneous connections on both TCP ports. Selecting the Modbus protocol for the port disables the DNP3/TCP server.

COM2 Settings

| Label | Parameter | Options | Default | Description |
|-------|-------------------------|---|------------|--|
| Prot | Communications protocol | ASCII = SATEC ASCII rtu = Modbus RTU dnP3 = DNP3 dtE = DTE | Modbus RTU | The communications protocol supported by the port |
| rS | Port interface | 485 = RS-485 422 = RS-422 | RS-485 | |
| Addr | Device address | SATEC ASCII: 0-99 Modbus RTU: 1-247 DNP3: 0-65532 DTE: 1-65532 | 1 | Device network address |
| bAud | Baud rate | 300-115200 bps | 19200 bps | The port baud rate |
| dAtA | Data format and parity | 7E, 8N, 8E | 8N | 7E data format should not be used with the Modbus RTU and DNP3 protocols |

Network Address

This menu allows you to configure the device IP address and the default gateway address for the Ethernet port. To enter the menu, select "nEt" from the Main menu, and then press the ENTER button.

To change the IP Address and Default Gateway:

- To change the device IP address, select the "A" entry in the upper window with the UP and DOWN arrow buttons. To change the default gateway address, select the "G" entry.
- Press the SELECT button to activate the first address digit.
- Use the UP and DOWN arrow buttons to adjust the digit.
- Press the SELECT button to advance to the next digit.
- Adjust the remaining address digits.

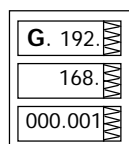
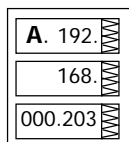

- Press ENTER to confirm your new setting, or press ESC to discard changes.

To exit the menu, press ESC.

Counters Setup

The PM172 has four six-digit counters that can count pulses delivered through the device digital inputs with a programmable scale factor, or events that trigger setpoint operations. This menu allows you to link digital inputs to the counters and define a pulse multiplier for each counter. To enter the menu, select the “Cnt” entry from the Main menu and press the ENTER button.

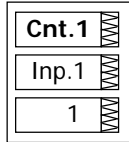

The menu uses three entries:

- The upper window indicates a counter number.
- The middle window selects a digital input to be linked to the counter.
- The lower window defines a counter multiplier.

Use the UP and DOWN arrow buttons to scroll to the desired counter.

To change the counter options:

- Press the SELECT button to activate the middle window.
- Use the UP and DOWN arrow buttons to link a digital input to the counter or to disable the counter input.
- Press the SELECT button to activate the lower window.
- Use the UP and DOWN arrow buttons to enter the desired multiplier.
- Press ENTER to confirm your changes and to store your new settings, or press ESC to discard changes.
- You are returned to the upper window to select another counter or exit the menu.

To exit the menu, press ESC.

The following table lists available counter options.

| Parameter | Options | Default | Description |
|--------------|---|---------|--|
| Pulse source | None = disabled Inp.1 = D11 Inp.2 = D12 | None | Links a digital input to the counter |
| Multiplier | 1-9999 | 1 | The value added to the counter when a pulse is detected on the pulse source input, or the counter is incremented through a setpoint action |

Relay Output Setup

To enter the menu, select the “rEL” entry from the Main menu and press the ENTER button.

Use the UP and DOWN arrow buttons to scroll to the desired relay.

To select a relay parameter:

- Press the SELECT button to activate the middle window.
- Use the UP and DOWN arrow buttons to scroll to the desired parameter.

To change the parameter value:

- Press the SELECT button to activate the lower window.

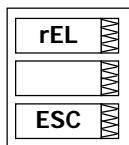

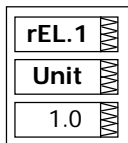
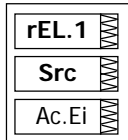
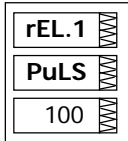
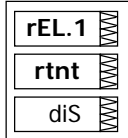
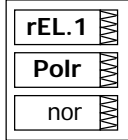
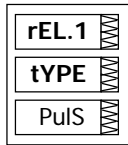

2. Use the UP and DOWN arrow buttons to select the desired value.
3. Press ENTER to confirm the new parameter setting, or press ESC to discard changes.
4. You are returned to the middle window to select and configure another parameter, or confirm the settings and exit the menu.

To store your new settings:

1. When the middle window is highlighted, press the ENTER button.
2. You are returned to the upper window to select another relay or exit the menu.

To exit the menu, press ESC.

The following table lists available relay options.

| Label | Parameter | Options | Default | Description |
|-------|-----------------------|---|---------------|---|
| tYPE | Operation mode | UnLt = Unlatched Ltch = Latched PLS.A = Pulse PLS.C = KYZ pulse | UnLt | See Using Relay Outputs in Chapter 4 |
| Polr | Polarity | nor = Normal (N.O.) InS = Inverting (N.C.) | nor | See Using Relay Outputs in Chapter 4 |
| rtnt | Retentive mode | diS = Disabled En = Enabled | diS | See Using Relay Outputs in Chapter 4 |
| PuLS | Pulse width | 20-1000 ms | 100 ms | The actual pulse width is a multiple of the 1-cycle time rounded to the nearest bigger value. The pause time between pulses is equal to the pulse width. |
| Src | Pulse source | nonE Ac.Ei = kWh IMP Ac.EE = kWh EXP rE.Ei = kvarh IMP rE.EE = kvarh EXP rE.Et = kvarh TOT AP.Et = kVAh | NONE | Links a pulse relay to the internal energy pulse source. The relay must be set into either pulse, or KYZ mode. |
| Unit | Pulse rate, kWh/Pulse | 0.1-1000.0 | 1.0 kWh/Pulse | Defines the pulse weight in kWh units per pulse |

Control Setpoints Setup

The PM172 provides 16 control setpoints with programmable operate and release delays. Each setpoint evaluates a logical expression with up to four arguments using OR/AND logic. Whenever an expression is evaluated as “true”, the setpoint performs up to four concurrent actions that send a command to the output relays, increment or decrement a counter, or trigger a recorder. For more information on setpoints operation, see “Using Control Setpoints” in Chapter 4.

This menu configures setpoints through the front display. To enter the menu, select the “SEtP” entry from the Main menu, and press the ENTER button.

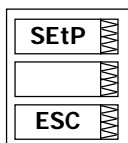

The menu uses three entries:

1. The upper window indicates a setpoint number.
2. The middle window selects a setup parameter to view or change.
3. The lower window displays the parameter value.

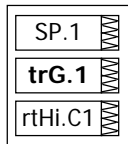

Use the UP and DOWN arrow buttons to scroll to the desired setpoint.

To select a setpoint parameter:

1. Press the SELECT button to activate the middle window.
2. Use the UP and DOWN arrow buttons to scroll to the desired parameter.

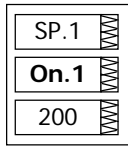

To change the parameter value:

1. Press the SELECT button to activate the lower window.
2. Use the UP and DOWN arrow buttons to select the desired value.
3. Press ENTER to confirm the new parameter setting, or press ESC to discard changes.
4. You are returned to the middle window to select and configure another parameter, or confirm the setpoint settings and exit the menu.

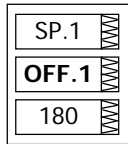

To store your new setpoint settings after you configured all setpoint parameters:

1. When the middle window is highlighted, press the ENTER button.
2. You are returned to the upper window to select another setpoint or exit the menu.

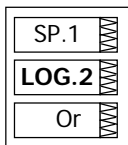

To exit the menu, press ESC.

The following table lists available setpoint options. For a list of available setpoint triggers and actions, see “Using Control Setpoints” in Chapter 4.

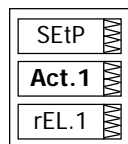
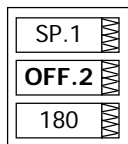
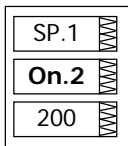
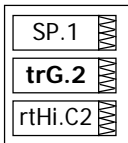

| Label | Parameter | Options | Description |
|-------------|-------------------------|----------------|--|
| LGC.2-LGC.4 | Logical operator | OR, AND | Combines setpoint triggers in a logical expression |
| TrG.1-TrG.4 | Trigger parameter #1-#4 | See Appendix C | The analog or digital value that is used as an argument in a logical expression |
| On.1-On.4 | Operate limit | | The threshold (in primary units) at which the conditional expression would be evaluated to true. Not applicable for digital triggers. |
| OFF.1-OFF.4 | Release limit | | The threshold (in primary units) at which the conditional expression would be evaluated to false. Defines the hysteresis for analog triggers. Not applicable for digital triggers. |
| Act.1-Act.4 | Setpoint action #1-#4 | See Appendix C | The action performed when the setpoint expression is evaluated to true (the setpoint is in operated state) |
| On d | Operate delay | 0-999.9 sec | The time delay before operation when the operate conditions are fulfilled |
| OFF d | Release delay | 0-999.9 sec | The time delay before release when the release conditions are fulfilled |

Analog Inputs Setup

This entry appears only if the meter is ordered with optional analog inputs. For more information on configuring analog inputs in your meter, see “Programming Analog Inputs” in Chapter 4.

To enter the menu, select the “A.In.1” or “A.In.2” entry from the Main menu for the AI1 and AI2 input respectively, and press the ENTER button.

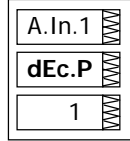
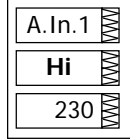
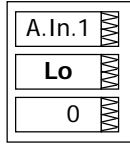
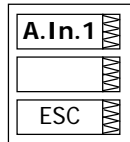

To change the analog input options:

1. Use the UP and DOWN arrow buttons to scroll to the desired parameter.
2. Press the SELECT button to activate the lower window.
3. Use the UP and DOWN arrow buttons to adjust the parameter value.
4. Press ENTER to confirm the new parameter setting, or press ESC to discard changes.
5. You are returned to the middle window to select another parameter, or store your new settings and exit the menu.

To store new settings and exit the menu:

1. When the middle window is highlighted, press the ENTER button.
2. You return to the main menu.

To exit the menu without saving your changes, press ESC.

The following table lists available analog input options.

| Label | Parameter | Options | Description |
|-------|--------------------------|-----------|--|
| Lo | Zero scale | 0-999,999 | The low engineering scale (in primary units) for the analog input corresponding to a lowest (zero) input current (0 or 4 mA) |
| Hi | Full scale | 0-999,999 | The high engineering scale (in primary units) for the analog input corresponding to a highest input current (1 or 20 mA) |
| dEc.P | Number of decimal places | 0-3 | The number of decimal digits in a fractional part of the scaled engineering value |

Analog Outputs Setup

This entry appears only if the meter is ordered with optional analog outputs. For more information on configuring analog inputs in your meter, see “Programming Analog Outputs” in Chapter 4.

To enter the menu, select the “A.Ou.1” or “A.Ou.2” entry from the main menu for the AO1 and AO2 output respectively, and then press the ENTER button.

To change the analog output options:

1. Use the UP and DOWN arrow buttons to scroll to the desired parameter.
2. Press the SELECT button to activate the lower window.
3. Use the UP and DOWN arrow buttons to adjust the parameter value.
4. Press ENTER to confirm your new parameter setting, or press ESC to discard changes.
5. You are returned to the middle window to select another parameter, or store your new settings and exit the menu.

To store new settings and exit the menu:

1. When the middle window is highlighted, press the ENTER button.
2. You return to the main menu.

To exit the menu without saving your changes, press ESC.

The following table lists available analog output options. For a list of the available output parameters and their scales, see “Programming Analog Outputs” in Chapter 4.

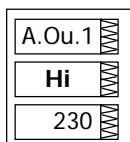
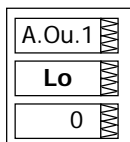
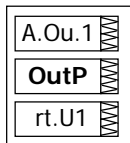
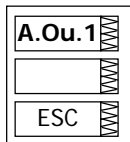

| Label | Parameter | Options | Description |
|-------|------------------|----------------|--|
| OutP | Output parameter | See Appendix B | Selects the measured parameter to be transmitted through the analog output channel. |
| Lo | Zero scale | | Low engineering scale (in primary units) for the analog output corresponding to a lowest (zero) output current (0 or 4 mA) |
| Hi | Full scale | | High engineering scale (in primary units) for the analog output corresponding to a highest output current (1 or 20 mA) |

Analog Expander Setup

The meter can provide 16 additional analog outputs via two optional AX-8 analog expanders that are connected through a serial RS-422 interface to the meter port COM2. Each expander has its own address 0 or 1 on the serial interface.

This menu allows you to assign parameters for the expanded analog outputs and to specify their scales. For more information on configuring the analog expander outputs in your meter, see “Programming the Analog Expander” in Chapter 4.

To enter the menu, select the “AEPn” entry from the Main menu, and press the ENTER button.

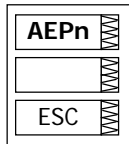

The expanded analog outputs are labeled in the following manner: analog output channels A1-1 through A1-8 are associated with the analog expander with address 0, while outputs A2-1 through A2-8 are associated with the analog expander with address 1.

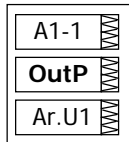

The menu uses three entries:

1. The upper window indicates an analog expander’s output channel.
2. The middle window selects a setup parameter to view or change.
3. The lower window displays the parameter value.

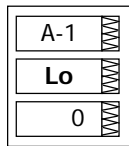

Use the UP and DOWN arrow buttons to scroll to the desired analog expander channel.

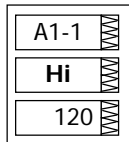

To select a setup parameter:

1. Press the SELECT button to activate the middle window.
3. Use the UP and DOWN arrow buttons to scroll to the desired parameter.

To change the parameter value:

1. Press the SELECT button to activate the lower window.
2. Use the UP and DOWN arrow buttons to select the desired value.
3. Press ENTER to confirm the new parameter setting, or press ESC to discard changes.
4. You are returned to the middle window to select and configure another parameter, or confirm the analog output settings and exit the menu.

To store your new settings after you configured all parameters:

1. When the middle window is highlighted, press the ENTER button.

- You are returned to the upper window to select another analog output or exit the menu.

To exit the menu, press ESC.

The following table lists available analog output options.

| Label | Parameter | Options | Description |
|-------|------------------|----------------|--|
| OutP | Output parameter | See Appendix B | Selects the measured parameter to be transmitted through the analog expander channel. |
| Lo | Zero scale | | Low engineering scale (in primary units) for the analog output corresponding to a lowest (zero) output current (0 or 4 mA) |
| Hi | Full scale | | High engineering scale (in primary units) for the analog output corresponding to a highest output current (1 or 20 mA) |

 Analog expander outputs will not be operational until you globally enable the analog expander option in your meter through the Device Options menu.

Timers Setup

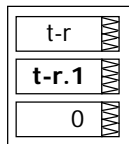

The PM172E and PM172EH are provided with two interval timers. When enabled, a timer generates periodic events in predefined intervals that can trigger setpoints to produce periodic actions like periodic data trending. To enter the menu, select the “t-r” entry from the Main menu and press the ENTER button.

Use the UP and DOWN arrow buttons to scroll to the desired timer.

To change the time period for the timer:

- Press the SELECT button to activate the lower window.
- Use the UP and DOWN arrow buttons to enter the desired interval value in seconds. Intervals from 1 to 9999 seconds are allowed. Resetting the interval to 0 disables the timer.
- Press ENTER to confirm your changes and to save the new settings, or press ESC to discard changes.
- You are returned to the middle window to select another timer or exit the menu.

To exit the menu, press ESC.

Display Setup

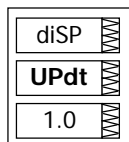

This menu allows you to configure options for the meter display, and view display and device firmware versions. To enter the menu, select the “diSP” entry from the Main menu and press the ENTER button.

To select a setup option:

- Press the SELECT button to activate the middle window.
- Use the UP and DOWN arrow buttons to scroll to the desired option.

To change the option:

- Press the SELECT button to activate the lower window.
- Use the UP and DOWN arrow buttons to select the desired option.
- Press ENTER to confirm your changes and to save the new setting, or press ESC to discard changes.

To exit the menu, press ESC.

The following table lists available options.

| Label | Parameter | Options | Default | Description |
|-------|--|--|----------|---|
| UPdt | Display update rate | 0.1-10.0 sec | 1 sec | Defines the interval between display updates |
| ScrL | Auto scroll interval | None, 2-15 sec | None | Defines the scroll interval for the main data display or disables auto scroll |
| rEtn | Auto return to the main screen | diS = disabled, En = Enabled | Enabled | Enables automatic return to the main display if no buttons are pressed for 5 minutes |
| bAr | Reference load current for LED bar graph | 0-20,000A (0 = CT primary current) | 0 | Defines the nominal load (100%) level for the bar graph display |
| Uolt | Primary/Secondary volts units | Pri, SEC | Primary | Selects primary or secondary units for volts display |
| Ph.P | Phase powers display mode | diS, En | Disabled | Disables or enables phase powers in the main display |
| Fund. | Fundamental component display mode | diS, En | Disabled | Disables or enables fundamental values in the main display |
| dAtE | Date order | dnY, ndY, Ynd (d=day, n=month, y=year) | mm.dd.yy | Defines the date order in the RTC display |
| rSt | Simple reset mode | PASS = password required En = enabled | PASS | PASS = the simple reset is not allowed when password protection is enabled En = enables the simple reset buttons regardless of password protection |
| SoFt. | Display firmware version | N/A | N/A | Shows display firmware version, like 1.2.8 |
| SoFt. | Device firmware version | N/A | N/A | Shows device firmware version, like 15.01.09 |

Meter Security

The Access Control menu allows you to change the user password and enable or disable password protection. To enter the menu, select the "AccS" entry from the main menu and press the ENTER button.

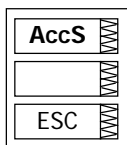

The password in your meter is preset to 0 at the factory, and password protection is disabled.

To change the password:

1. Select the "PASS" entry in the upper window with the UP and DOWN arrow buttons.
2. Press the SELECT button to activate the first password digit.
3. Use the UP and DOWN arrow buttons to adjust the digit.
4. Press the SELECT button to advance to the next digit.
5. Adjust the remaining password digits.
6. Press ENTER to confirm your new password.

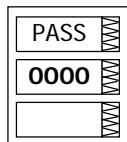

 Your new password is effective for both the display and communication ports.

To enable or disable password protection:

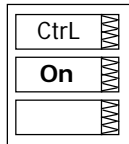

1. Select "Ctrl" in the upper window using the UP and DOWN arrow buttons.
2. Press the SELECT button to activate the middle window.
3. Use the UP and DOWN arrow buttons to select the desired option. "On" enables password protection, "OFF" disables password protection.
4. Press ENTER to confirm your new setting, or ESC to discard changes.

To exit the menu, press ESC.

△ When password protection is enabled in your meter, you are not able to change the device settings through the display or communications unless you provide a correct password. If you cannot provide a proper password, contact your local distributor for the appropriate password to override password protection.

Setting the Device Clock

To enter the menu, select the "rtc" entry from the Main menu and press the ENTER button. This menu allows you to set up the device clock and to configure your local time zone settings.

To select a setup option, use the UP and DOWN arrow buttons from the upper window.

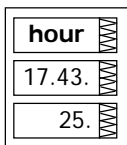

To change the time, date, or daylight savings setting:

1. Highlight an item you want to change by pressing briefly the SELECT button. When you enter the time setup display, the hours and minutes are frozen to allow you to adjust them.
2. Adjust the selected item with the UP and DOWN arrow buttons.
3. Highlight the next item you want to change and adjust it in the same manner.
4. Press ENTER to confirm your changes, or press ESC to leave the clock settings unchanged. If you confirm the time change while the seconds are highlighted, the seconds are zeroed; otherwise they stay unchanged.

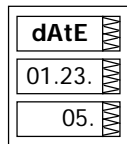

To exit the menu, press ESC.

The following table lists available options.

| Label | Option | Format/Range | Description |
|-------|-------------|--|---|
| hour | Time | hh.mm.ss | The time is displayed as hh.mm.ss, where the hours and minutes are shown in the middle window separated by a dot, and the seconds - in the lower window. |
| dAtE | Date | YY.MM.DD, MM.DD.YY, DD.MM.YY | The date is displayed as per the user definition, where the first two items are shown in the middle window, and the last one - in the lower window. For instructions on how to select the date format, see "Display Setup". |
| dAY | Day of week | Sun = Sunday Mon = Monday tuE = Tuesday UEd = Wednesday thu = Thursday Fri = Friday Sat = Saturday | The day of the week is displayed in the lower window. It is set automatically when you change the date. |

| Label | Option | Format/Range | Description |
|------------|-----------------------------|--|---|
| dSt | Daylight saving time option | diS = disabled En = enabled | When DST is disabled, the RTC operates in standard time only. When enabled, the device automatically updates the time at 2:00 AM at the pre-defined DST switch dates. |
| dSt.S | DST start date | Month-week-weekday Week = 1 st , 2 nd , 3 rd , 4 th or LSt (last week of the month) | The date when Daylight Saving Time begins. The DST switch point is specified by the month, week of the month and weekday. By default, DST starts at 2:00 AM on the second Sunday in March of each year. |
| dSt.E | DST end date | Month-week-weekday Week = 1 st , 2 nd , 3 rd , 4 th or LSt (last week of the month) | The date when Daylight Saving Time ends. The DST switch point is specified by the month, week of the month and weekday. By default, DST ends at 2:00 AM on the first Sunday in November of each year. |
| dSt.S Hour | DST start hour | 1-6 | The time when Daylight Saving Time begins. |
| dSt.E Hour | DST end hour | 1-6 | The time when Daylight Saving Time ends. |

Resetting Accumulators and Maximum Demands

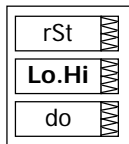

To enter the menu, select the “rst” entry from the Main menu, and then press the ENTER button.

The Reset menu allows you to separately reset minimum/maximum log records, maximum demands and counters.

To reset the desired registers:

1. Highlight the middle window by pressing briefly the SELECT button.
2. Select the desired entry by scrolling through the list with the UP and DOWN arrow buttons until the desired entry appears.
3. Press the SELECT button briefly to highlight the lower item.
4. Press and hold the ENTER button for 5 seconds.
5. Release the button. The “do” entry is replaced with “done” showing the operation is complete.

The following table shows available options.

| Label | Description |
|-------------|--|
| Lo.Hi | Clears Min/Max log |
| A.dnd | Clears maximum ampere, volt and harmonic demands |
| P.dnd | Clears maximum power demands |
| dnd | Clears all maximum demands |
| Enr | Clears all total energies |
| tOU.d | Clears summary and TOU maximum demands |
| tOU.E | Clears summary and TOU energy registers |
| Cnt | Clears all counters |
| Cnt1 – Cnt4 | Clears counter #1-#4 |

Chapter 4 PAS Application Software

Supplemental PAS software can be used for configuring the PM172 through communication ports, for retrieving real-time and recorded data, and for remote upgrading device firmware.

For information on how to install PAS on your PC, see the “PAS Getting Started” guide supplied on the installation CD.

Configuration Database

To communicate with your meters, create a separate site database for each device. All communication and configuration data for your meter is stored in this database. During configuration, store all setups to the site database so that PAS recognizes device properties regardless of whether the device is online or offline.

To create a new database for your meter:

1. Select Configuration from the Tools menu, and then click the Sites button on the right-hand side.

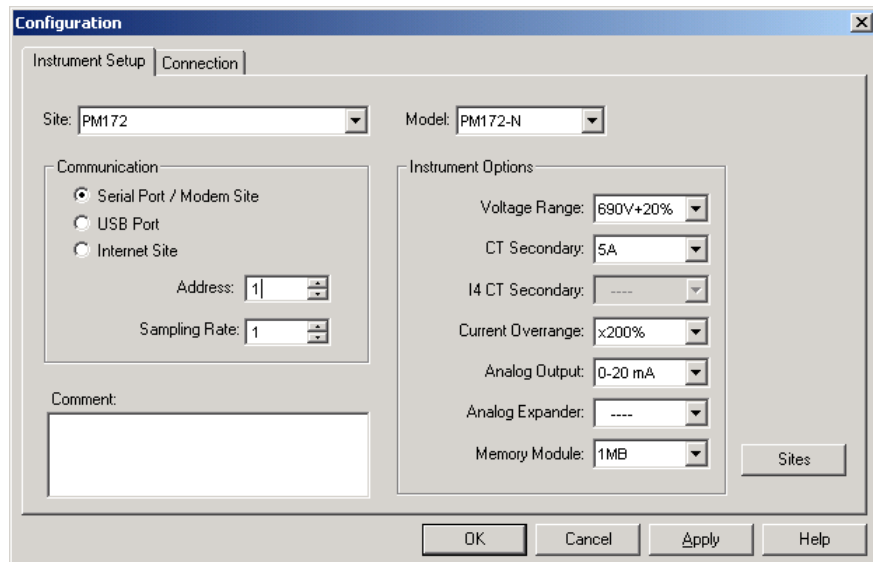

2. From the “Look in” box, select the directory where a new database will be stored. By default, it will be the “Sites” directory. Type a site name for your device in the “File name” box, click New, and then click OK.
3. On the Instrument Setup tab, select “PM172-N” for the PM172P and PM172E, or select “PM172EH-N” for the PM172EH, in the “Model” box. PAS automatically selects the appropriate instrument options for your meter.
4. Select a correct CT secondary current (5A or 1A) for your meter. If you have the analog expander connected to the meter, select an appropriate output current option for the analog expander.
5. If you wish to add any comments for your meter, type them into the “Comment” box.

Setting up Communications

You can communicate with the meter via a changeable COM1 communication port, or through a second factory set serial RS-485/RS-422 COM2 port. Depending on what was ordered, your meter’s COM1 port can

be equipped with an RS-232/RS-422/RS-485 serial interface, with a dial-up modem for communicating through public telephone lines, with an Ethernet module for communicating through the Internet, or with a Profibus port. PAS does not support communications through Profibus.

To configure your communications with the PM172:

1. Select Configuration from the Tools menu. Under the Communication group on the Instrument Setup tab, select the type of a connection for your device.
2. Set the device communication address you assigned to the PM172.
3. In the "Sampling Rate" box, select a rate at which PAS updates data on your screen when you continuously poll the device in the PAS Data Monitor.

The communication protocol and port settings in PAS must match the settings made in your device.

Communicating through a Serial Port

Select Serial Port/Modem Site on the Configuration tab, and then click on the Connection tab to configure your serial port settings.

Configuring a Serial Port

1. On the Connection tab, select a COM port from the "Device" box, and then click Configure.

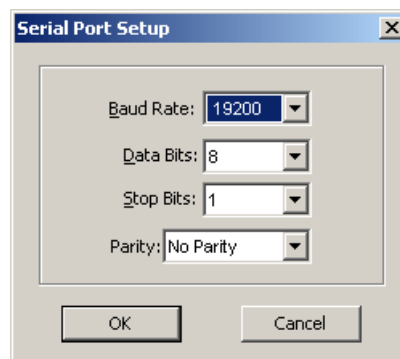

2. Specify the baud rate and data format for the port. Choose the same baud rate and data format as you have set in the device, and then click OK. The default settings for the local RS-232 and RS-422/485 ports are 19200 baud, 8 bits with no parity.

Selecting the Communications Protocol

1. On the Connection tab, click Protocol.

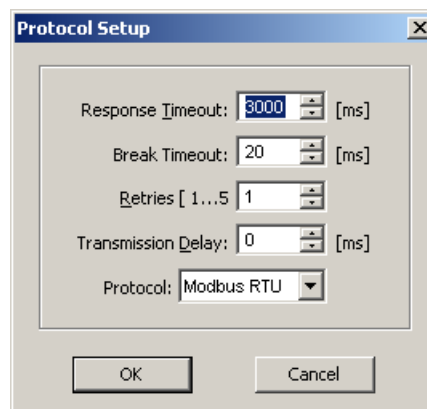

- In the “Protocol” box, select the same communications protocol as you have in your meter. The default protocol setting in your meter for all ports excluding the Profibus port is Modbus RTU.

For more information on configuring the protocol parameters, refer to the “PAS Getting Started” guide.

Communicating through a Dial-up Modem

Configuring a Modem

- On the Connection tab, select a local modem installed on your PC.
- Click on Phones to add the phone number of the remote meter to the phone list.
- Type the phone number in the “Phone number” box, add comments if you desire, click Add, and then click OK.
- From the “Phone number” box on the Connection tab, select the phone number from the list, and then click OK.

Selecting the Communications Protocol

On the Connection tab, click Protocol, and then select the protocol settings as shown above for a serial port.

Communicating through the Internet

If you are communicating through the Ethernet port, you should define the IP address of your meter on the network.

- On the Instrument Setup tab, select Internet Site.
- Click on the Connection tab.

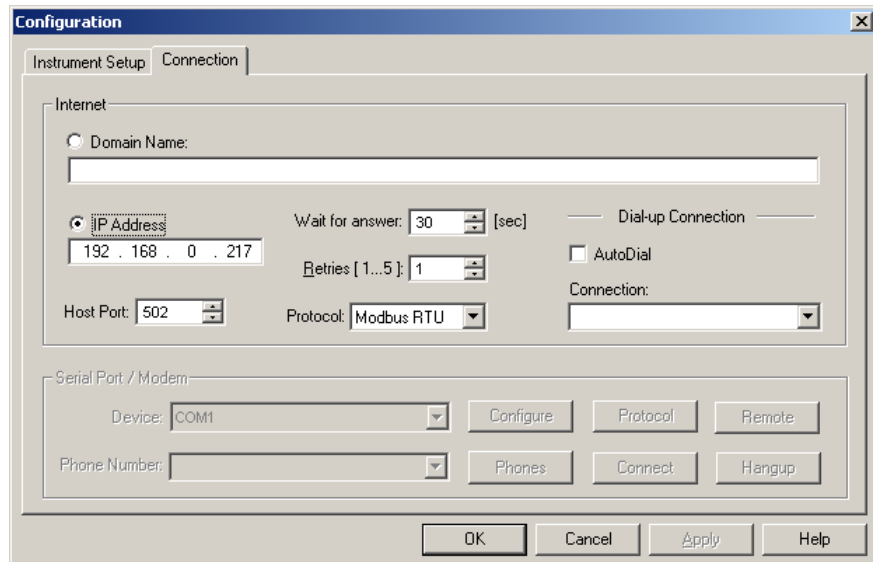

- Click on the “IP address” and type in the IP address of your meter. The default IP address preset at the factory is 192.168.0.203.
- In the “Protocol” box, select the communications protocol for the TCP port. The meter can provide Modbus/TCP connections on TCP port 502 and DNP3/TCP connections on port 20000. The host port is set automatically as you

select the protocol. Select “Modbus RTU” for Modbus/TCP or “DNP3” for DNP3/TCP.

5. In the “Wait for answer” box, adjust the time that PAS will wait for a connection before announcing an error and the number of retries PAS will use to receive a response from the device if communications fail.

Setting Up the Meter

PAS allows you to prepare setup data for the meter off-line without the need to have it connected to your PC.

Select the device site from the list box on the PAS toolbar, and then select the desired setup group from the Meter Setup menu. Click on the tab with the setup you want to create or modify, and then fill in the boxes with the desired configuration data for your device. Click on the “Save as...” button to store your new data to the site database.

 Always set up and store the Basic Setup data to the site database first. PAS uses this data as a reference when arranging other meter setups.

To save your setup to another site database, select it from the file pane. Click OK.

To reuse setups from another site, copy them to your present site database. Click Open, select the desired site database, and then click OK. The opened setup is copied to your site database.

You can also copy all setups from one site database into another site's database. Select a device site from the list box on the toolbar from which you want to reproduce setups, and then select “Copy to...” from the Meter Setup menu. Select the site database to which to copy setups, and click OK.

Downloading Setup to the Meter

You can update each setup in your meter one at a time or download all setups together from the site database.

To update a particular setup in your device, check the On-line button on the PAS toolbar, select a meter site from the list box on the toolbar, and then select the desired setup group from the Meter Setup menu. Click on the tab of the setup you want to download to the meter, and then click Send.

To download all setups to your device at once, check the On-line button on the toolbar, select the device site from the list box on the toolbar, and then select Download Setups from the Meter Setup menu.

Uploading Setup from the Meter

To upload the setup from the device to the site database, check the On-line button on the toolbar, select the device site from the list box on the toolbar, and then select Upload Setups from the Meter Setup menu.

Authorization

If communications with your device is secured, you are prompted for the password when you send new setup data to the meter.

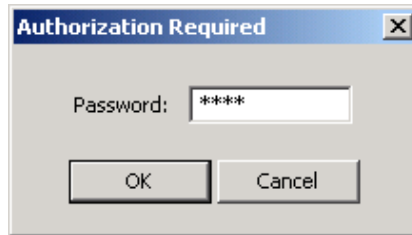

Enter the password and click OK. If your authorization was successful, you are not prompted for the password again until you close the dialog window.

Configuring Communications in your Meter

This section describes how to configure communication ports in your meter through PAS.

Setting Up Communication Ports

To enter the setup dialog, select the device site from the list box on the PAS toolbar, select Communications Setup from the Meter Setup menu, and then click on the Serial Ports Setup tab. In the Port box, select the desired device port.

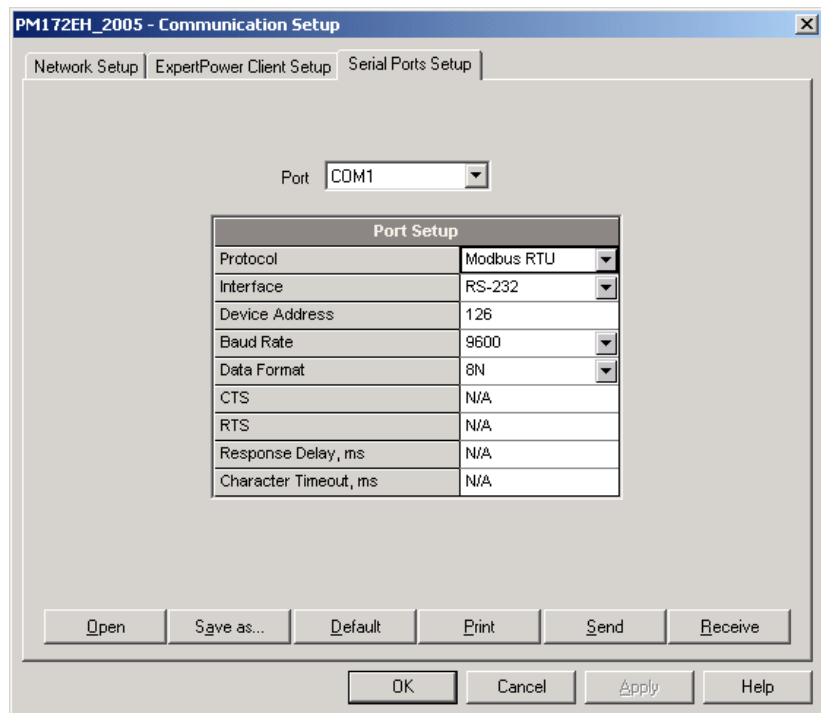

To change the port settings in your meter, select desired port parameters, and then click Send. For the available communication options, see "Communication Ports" in Chapter 3.

NOTES

1. The meter provides the permanent Modbus TCP server on port 502. Selecting the DNP3 protocol launches the DNP3 TCP server in addition to the Modbus server allowing simultaneous connections on both ports. Selecting the Modbus protocol disables the DNP3 TCP server.
2. When you change the COM1 settings through the Ethernet port, the device port restarts so communications

will be temporarily lost. You may need to wait some additional time until PAS restores a connection with your device.

Setting Up the Ethernet

To enter the Setup dialog, select the device site from the list box on the PAS toolbar, select Communications Setup from the Meter Setup menu, and then click on the Network Setup tab.

The following table lists available network options.

| Parameter | Options | Default |
|-------------------------|--------------------------------------|---------------|
| Device IP Address | | 192.168.0.203 |
| Network Subnet Mask | | 255.255.255.0 |
| Network Default Gateway | | 192.168.0.1 |
| TCP Service Port | 502 = Modbus/TCP 20000 = DNP3/TCP | 502 |

 The TCP service port can also be changed through the COM1 serial port setup: changing the protocol for the port automatically changes the TCP port for the Ethernet.

To change the Ethernet settings in your meter, select desired parameters, and then click Send.

NOTES

1. The meter provides the permanent Modbus TCP server on port 502. Selecting the DNP3 TCP service port launches the DNP3 TCP server in addition to the Modbus server allowing simultaneous connections on both ports. Selecting the Modbus TCP port disables the DNP3 TCP server.
2. When you change the device network settings through the Ethernet port, the device port restarts so communication will be temporarily lost. You may need to wait some

additional time until PAS restores a connection with your device.

Configuring GE EGD Production Exchanges

The PM172 provides a GE EGD (Ethernet Global Data) data producer that supports four data exchanges. Each data exchange is individually configurable and can produce and send data to the same or to different consuming nodes. For EGD implementation and configuration details, see the PM172 GE EGD Communications Protocol Reference Guide.

To enter the Setup dialog, select the device site from the list box on the PAS toolbar, select Communications Setup from the Meter Setup menu, and then click on the GE EGD Producer Setup tab.

The screenshot shows the 'PM172-N - Communication Setup' dialog box with the 'GE EGD Producer Setup' tab selected. The dialog contains the following configuration fields and table:

| EGD Producer Exchanges | | | | |
|-----------------------------------|--------------------|----------------|--------------|-----------|
| Exchange ID | #1 | | | |
| Consumer IP Address | 192 . 168 . 0 . 45 | | | |
| Production Period, [70-600000] ms | 70 | | | |
| Exchange Status | Enabled | | | |
| Address Ranges | | | | |
| No. | Offset | Start Point ID | End Point ID | Data Type |
| 1 | 0 | 3072 | 3077 | Float |
| 2 | 24 | 3840 | 3843 | Float |
| 3 | 40 | 4098 | 4098 | Float |
| 4 | 44 | 5888 | 5889 | DWord |
| 5 | 52 | 1536 | 1536 | Word |
| 6 | 54 | 0 | 0 | Word |
| 7 | ---- | ---- | ---- | ---- |
| 8 | ---- | ---- | ---- | ---- |
| 9 | ---- | ---- | ---- | ---- |
| 10 | ---- | ---- | ---- | ---- |

Buttons at the bottom of the dialog include: Open, Save as..., Default, Print, Send, Receive, OK, Cancel, Apply, and Help.

To configure an EGD exchange:

1. Select a desired exchange ID.
2. Specify a destination IP address of the data-consuming node.
3. Specify the production period for the exchange. The PM172 exchanges provide production rates from 70 ms to 10 minutes in 10 ms increments. Though lower settings are allowed, the actual production period in most cases will not be less than 70 ms.
4. Select "Enabled" in the Exchange Status box to enable the exchange operations.
5. Define address ranges for the points to be sent via the exchange and the data element type for each address range. Up to 30 point ranges can be selected for each exchange that may identify a single point or a range of contiguous points.

Specify the data ranges using the range start point and end point identifiers (ID) in decimal notation. For the available device data points and their IDs, refer the

PM172 GE EGD Communications Protocol Reference Guide.

Select a desired data type for the point range. Data transferred through the exchange can be represented in word (16-bit) or double word (32-bit) integer format, or in IEEE single precision floating-point format.

As you specify an address range for the exchange, PAS immediately shows you the data offset in bytes in the production data area for the following range. Each exchange can send a total of 480 bytes of production data. PAS automatically truncates your range if you specify more data than the exchange can accommodate.

To indicate the end of the address range list, put a zero start point ID in the range following the last range you specified.

6. Click on Send to download your new setup to the meter. The device will reject your setup if you specified an inexistent start point ID for one of the address ranges. If you specified more points in a range than the device can provide, it truncates the range to the maximum number of points available.

From this dialog box, you can also temporarily put a configured exchange into the pending (disabled) state, and then resume (enable) it whenever needed.

NOTE

When you change the consumer IP address for an exchange through the Ethernet, the device port restarts so communications will be temporarily lost. You may need to wait some additional time until PAS restores a connection with your device.

General Meter Setup

This section describes how to configure the PM172 for your particular environment and application using PAS.

Basic Meter Setup

Before operating your meter, provide the device with basic information about your electrical network.

To enter the Setup dialog, select the device site from the list box on the PAS toolbar, and then select General Setup from the Meter Setup menu.

The following table lists available device configuration options.

| Parameter | Options | Default | Description |
|-------------------------------|-----------------|---------|---|
| Basic Configuration | | | |
| Wiring mode | See Table below | 4LN3 | The wiring connection of the device |
| PT ratio ¹ | 1.0-6500.0 | 1.0 | The phase potential transformer's primary to secondary ratio |
| PT Ratio multiplier | ×1, ×10 | ×1 | PT Ratio multiplication factor. Used in extra high voltage networks to accommodate the PT ratio for 500 kV and higher networks. |
| CT primary current | 1-20,000 A | 5 A | The primary rating of the phase current transformer |
| Nominal voltage ^{EH} | 10-690 V | 120 V | The nominal secondary line-to-neutral or line-to-line voltage. Used as a reference voltage for the disturbance monitor. |
| Maximum demand load current | 0-20,000 A | 0 | The maximum demand load current (0 = CT primary current) |
| Nominal frequency | 50,60,25,400 Hz | 60 Hz | The nominal line frequency |

| Parameter | Options | Default | Description |
|---|---|---------|--|
| Demand Setup | | | |
| Power block demand period ^E | 1, 2, 3, 5, 10, 15, 20, 30, 60 min, E=external sync | 15 min | The length of the demand period for power demand calculations. If the external synchronization is selected, a pulse front on the digital input DI1 denotes the start of the demand interval. |
| Number of blocks in sliding demand ^E | 1-15 | 1 | The number of blocks to be averaged for sliding window demands |
| Volt/Ampere/THD demand period | 0-1800 sec | 900 sec | The length of the demand period for ampere, volt and THD demand calculations |

¹ PT Ratio is defined as a relation of the potential transformer's primary voltage rating to its secondary rating. For example, for the 14,400 V transformer's primary rating and 120 V secondary rating, the PT Ratio = 14400/120 = 120.

Available wiring modes are listed in the following table.

| Wiring Mode | Description |
|-------------|---|
| 3OP2 | 3-wire Open Delta using 2 CTs (2 element) |
| 4LN3 | 4-wire Wye using 3 PTs (3 element), line-to-neutral voltage readings |
| 3DIR2 | 3-wire Direct Connection using 2 CTs (2 element) |
| 4LL3 | 4-wire Wye using 3 PTs (3 element), line-to-line voltage readings |
| 3OP3 | 3-wire Open Delta using 3 CTs (2½ element) |
| 3LN3 | 4-wire Wye using 2 PTs (2½ element), line-to-neutral voltage readings |
| 3LL3 | 4-wire Wye using 2 PTs (2½ element), line-to-line voltage readings |
| 3BLN3 | 3-wire Broken Delta using 2 PTs, 3 CTs (2½-element), line-to-neutral voltage readings |
| 3BLL3 | 3-wire Broken Delta using 2 PTs, 3 CTs (2½-element), line-to-line voltage readings |

△ In 4LN3, 3LN3 and 3BLN3 wiring modes, the voltage readings for min/max volts and volt demands represent line-to-neutral voltages; otherwise, they will be line-to-line voltages. The voltage waveforms and harmonics in 4LN3, 4LL3, 3LN3, 3LL3, 3BLN3 and 3BLL3 wiring modes represent line-to-neutral voltages; otherwise, they will be line-to-line voltages.

Device Options

This setup allows you to enable or disable optional calculations and redefine user-selectable device options.

To enter the setup dialog, select the device site from the list box on the PAS toolbar, and then select Device Options from the Meter Setup menu.

The following table lists available device options.

| Parameter | Options | Default | Description |
|------------------------|--|-------------|--|
| Power Calculation Mode | S=f(P, Q) (using reactive power), Q=f(S, P) (using non-active power) | S=f(P, Q) | The method used for calculating reactive and apparent powers (see "Power Calculation Modes" below) |
| Energy Roll Value | 1000.0 kWh 10000.0 kWh 100000.0 kWh 1000000.0 kWh 10000000.0 kWh | 100000000.0 | The value at which energy counters roll over to zero |

| Parameter | Options | Default | Description |
|-------------------------------------|--|----------|---|
| Phase Energy Calculation | Disabled, Enabled | Disabled | Enables phase energy calculations |
| Harmonic Power/Energy Calculation | Disabled, Enabled | Disabled | Enables harmonic power and energy calculations |
| Analog Expander Option ¹ | Disabled 0-20 mA 4-20 mA 0-1 mA ± 1 mA | Disabled | Enables outputs for the AX-8 analog expanders through port COM2. See "Programming the Analog Expander" |
| Backup Battery | OFF = switched OFF On = switched ON | OFF | Allows to conserve a battery while the meter is out of operation |
| Energy Test Mode ^E | OFF = disabled Wh pulses varh pulses | Disabled | Setting this option puts the meter into the energy test mode |
| Volts Scale, V | 10-828 V | 144 V | The maximum voltage scale allowed, in secondary volts. See Data Scales in Appendix E. |
| Amps Scale, A | 2 \times nominal CT secondary current (2A, 10A) | 2A/10 A | The maximum current scale allowed, in secondary amps. Not changeable. See Data Scales in Appendix E. |
| Starting Current, %FS | 0.1-2.0 | 0.1%FS | Specifies the low current measurement limit in percent of the full scale current (1A, 5A). Available in the PM172P/E, V13.1.19 and later. |

¹ Do not enable the analog expander output if you do not have the analog expander connected to the meter, otherwise it will disturb the computer communications.

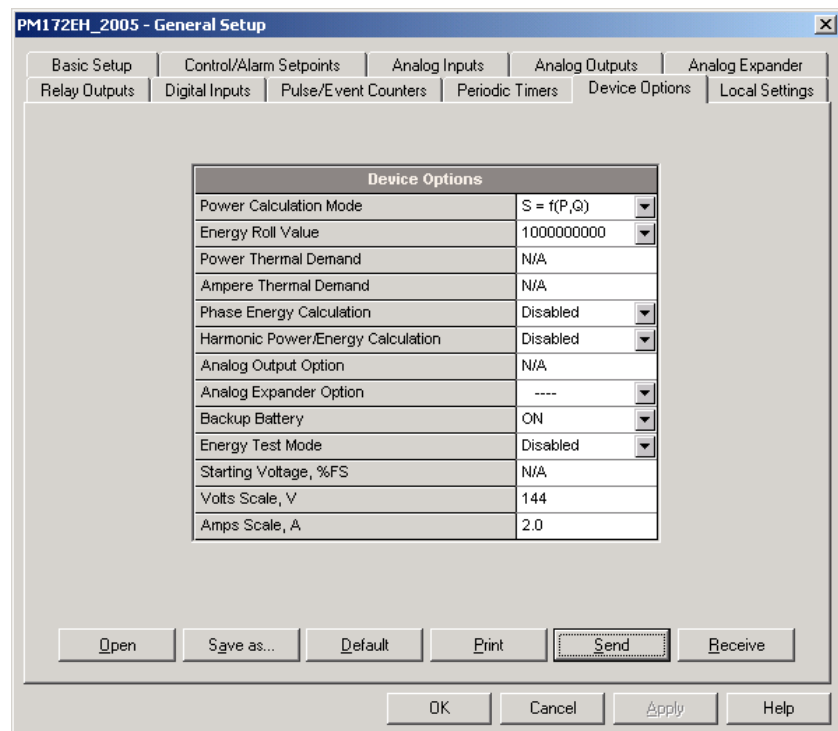

Power Calculation Modes

The power calculation mode option allows you to change the method for calculating reactive and apparent powers in presence of high harmonics. The options work as follows:

1. When the reactive power calculation mode is selected, active and reactive powers are measured directly and apparent power is calculated as:

$$S = \sqrt{P^2 + Q^2}$$

This mode is recommended for electrical networks with low harmonic distortion, commonly with THD < 5% for volts, and THD < 10% for currents. In networks with high harmonics, the following method is preferable.

2. When the non-active power calculation mode is selected, active power is measured directly, apparent power is taken as product $S = V \times I$, where V and I are the RMS volts and amps, and reactive power (called non-active power) is calculated as:

$$N = \sqrt{S^2 - P^2}$$

Transformer Correction

This setup is available in the PM172P/E with firmware V13.1.19 and later, or V13.71.12 and later.

Transformer correction allows you to compensate ratio and phase angle inaccuracies of the user voltage and current instrument transformers.

To enter the setup dialog, select the device site from the list box on the PAS toolbar, and then select Transformer Correction from the Meter Setup menu.

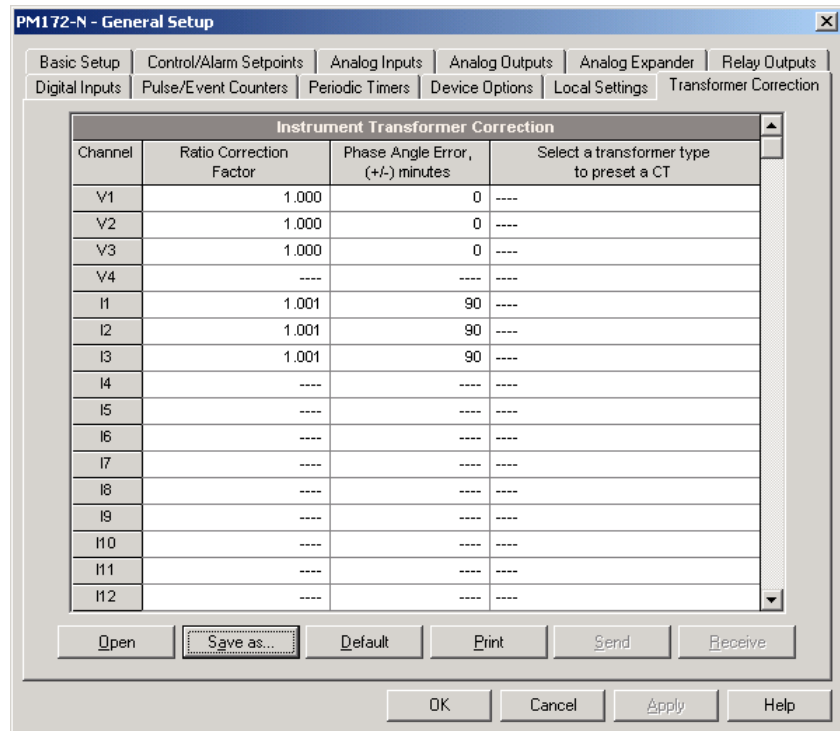

The following table lists available options.

| Parameter | Options | Default | Description |
|-------------------------|----------------|---------|--|
| Ratio Correction Factor | 0.900 to 1.100 | 1.000 | The ratio of the true transformer ratio to the marked ratio. |

| Parameter | Options | Default | Description |
|----------------------------|---|---------|--|
| Phase Angle Error, minutes | -600 to 600 (-2700 to 2700 with V13.7X.XX) | 0 | The phase displacement, in minutes, between the primary and secondary values. The phase angle of a transformer is positive when the secondary value leads the primary value. |

Local Settings

This setup allows you to specify your time zone and daylight saving time options.

To configure the time zone options for your device, select the device site from the list box on the PAS toolbar, select General Setup from the Meter Setup menu, and then click on the Local Settings tab.

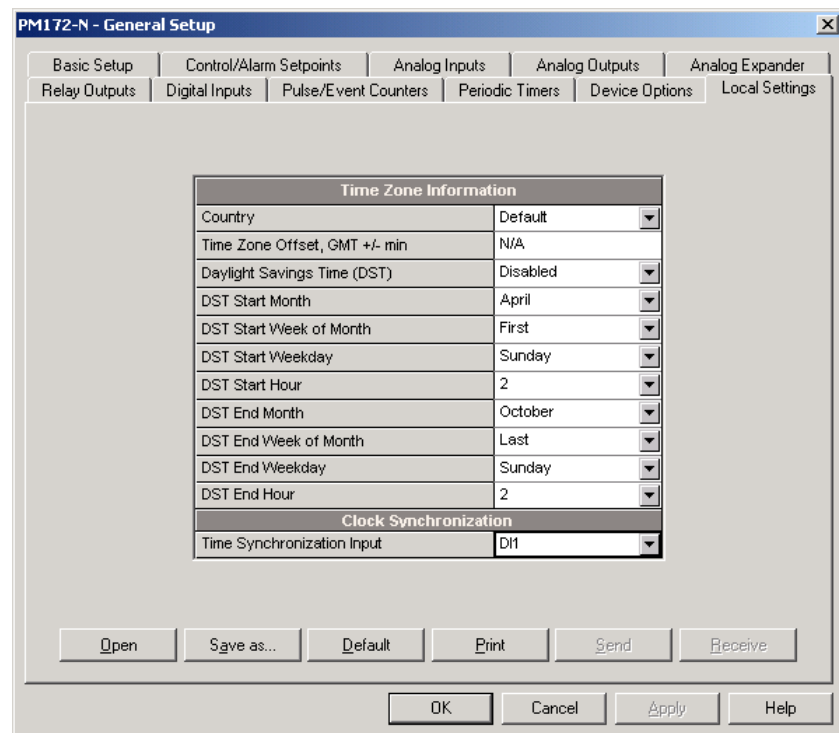

The available options are described in the following table:

| Parameter | Options | Default | Description |
|--|---|------------------------|---|
| Country | Default, or country name | Default | Defines calendar setting. The default setting stands for the U.S.A. |
| Daylight saving time | Disabled Enabled | Disabled | When DST is disabled, the RTC operates in standard time only. When enabled, the device automatically updates the time at 2:00 AM at the pre-defined DST switch dates. |
| DST start month DST start week DST start weekday | Month-week-weekday Week = 1 st , 2 nd , 3 rd , 4 th or Last (last week of the month) | Second Sunday in March | The date when Daylight Saving Time begins. The DST switch point is specified by the month, week of the month and weekday. By default, DST starts at 2:00 AM on the second Sunday in March of each year. |
| DST Start Hour | 1-6 | 2 | The hour when Daylight Saving Time begins. |

| Parameter | Options | Default | Description |
|--|---|--------------------------|---|
| DST end month DST end week DST end weekday | Month-week-weekday Week = 1 st , 2 nd , 3 rd , 4 th or Last (last week of the month) | First Sunday in November | The date when Daylight Saving Time ends. The DST switch point is specified by the month, week of the month and weekday. By default, DST ends at 2:00 AM on the first Sunday in November of each year. |
| DST End Hour | 1-6 | 2 | The hour when Daylight Saving Time ends. |
| Time synchronization input | None DI1 DI2 | None | The external port receiving the time synchronization pulses |

Daylight Saving Time

When the daylight saving time is enabled, the meter automatically advances the device clock one hour (by default at 02.00 AM) when daylight saving time begins and puts the clock back one hour (by default at 02.00 AM) when it ends. The default daylight saving time change points are preset for the U.S.A.

The daylight saving time option is disabled in the PM172 by default. If the daylight saving time option is disabled, you need to manually adjust the device clock for daylight saving time.

Time Synchronization Pulses

External time synchronization pulses can be delivered through one of the digital inputs. If a digital input is selected as the time synchronization source, the edge of an external pulse adjusts the device clock at the nearest whole minute. The time accuracy could be affected by the debounce time of the digital input, and by the operation delay of the external relay.

Using Digital Inputs

The meter is provided with two digital inputs that can trigger the alarm/control setpoints to give an alarm on input status change, or can be linked to the energy/TOU registers to count pulses from external watt meters, or gas and water meters.

To configure them in your device, select the device site from the list box on the PAS toolbar, select General Setup from the Meter Setup menu, and then click on the Digital Inputs tab.

The available options are shown in the following table.

| Parameter | Options | Default | Description |
|------------------|------------------------------------|------------|--|
| Pulse input mode | PULSE MODE, KYZ MODE | PULSE MODE | In pulse mode, either leading, or trailing edge of the input pulse is recognized as an event. In KYZ mode, both leading and trailing edges of the input pulse are recognized as separate events. |
| Pulse polarity | NORMAL (N.O.), INVERTING (N.C.) | NORMAL | For the normal polarity, the open to closed transition is considered a pulse. For the inverting polarity, the closed to open transition is considered a pulse. It has no meaning in KYZ mode where both transitions are used. |
| Debounce time | 1-1000 ms | 10 ms | The amount of time while the state of the digital input should not change to be recognized as a new state. Too low debounce time could produce multiple events on the input change. |

The debounce time is used the same for both digital inputs. If you change the debounce time for one digital input, the same debounce time is automatically assigned to the other.

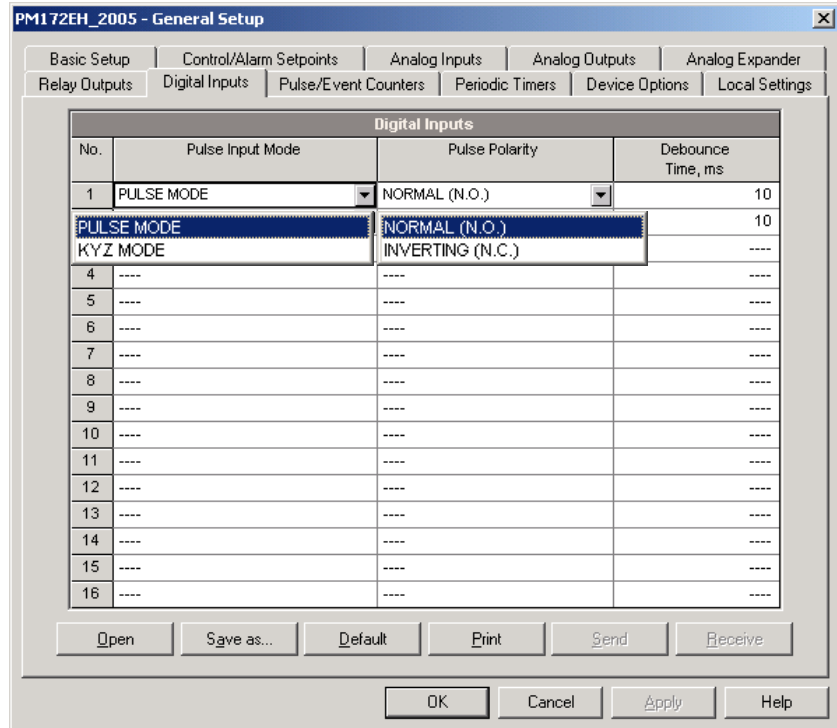

Using Relay Outputs

The PM172 is equipped with two relays. Each relay can be operated either locally from the alarm/control setpoints in response to an external event, or by a remote command sent through communications, and can also be linked to an internal pulse source to produce energy pulses.

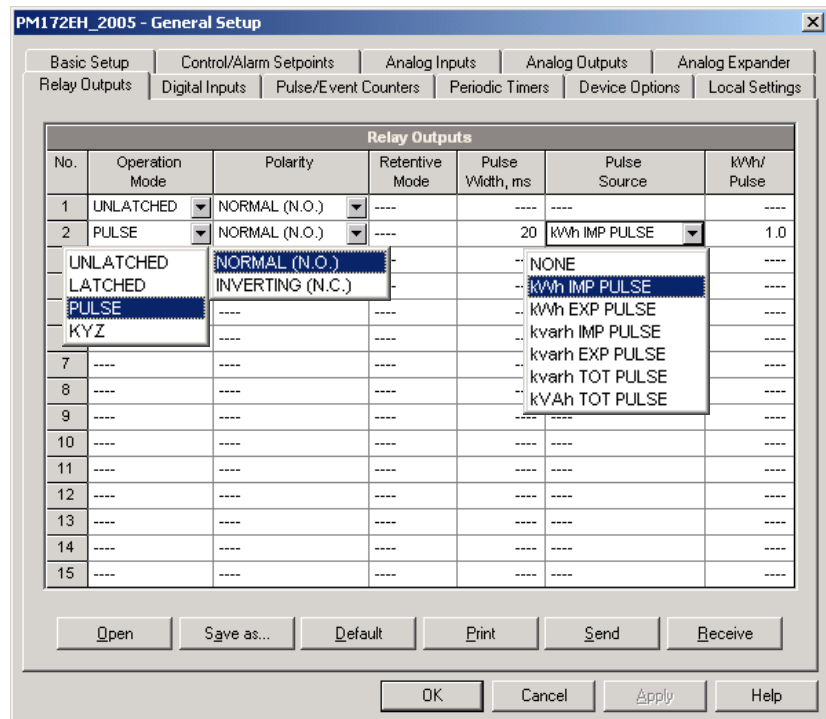

The available relay options are shown in the following table:

| Parameter | Options | Default | Description |
|-----------------------|---|---------------|---|
| Operation mode | UNLATCHED LATCHED PULSE KYZ | UNLATCHED | Unlatched mode: the relay goes into its active state when the control setpoint is in active (operated) state, and returns into its non-active state when the setpoint is released. Latched mode: the relay goes into its active state when the control setpoint goes into active state and remains in the active state until it is returned into its non-active state by a remote command. Pulse mode: the relay goes into its active state for the specified time, goes into non-active state for the specified time and remains in the non-active state. KYZ mode: the relay generates transition pulses. The relay changes its output state upon each command and remains in this state until the next command. |
| Polarity | NORMAL (N.O.) INVERTING (N.C.) | NORMAL | With normal polarity, the relay is normally de-energized in its non-active state and is energized in its active (operated) state. With inverting polarity, the relay is normally energized in its non-active state and is de-energized in its active (operated) state. It is called failsafe relay operation. |
| Retentive mode | NO YES | NO | Applicable for latched relays. In non-retentive mode, the relay always returns to its non-active state upon power up. In retentive mode, the relay status is restored to what it was prior to loss of power. |
| Pulse width | 20-1000 ms | 100 ms | The actual pulse width is a multiple of the 1-cycle time rounded to the nearest bigger value. The pause time between pulses is equal to the pulse width. |
| Pulse source | NONE kWh IMP kWh EXP kvarh IMP kvarh EXP kvarh TOT kVAh | NONE | Links a pulse relay to the internal energy pulse source. The relay must be set into either pulse, or KYZ mode. |
| Pulse rate, kWh/Pulse | 0.1-1000.0 | 1.0 kWh/Pulse | Defines the pulse weight in kWh units per pulse |

Generating Energy Pulses through Relay Outputs

To generate energy pulses through a relay output:

1. Set a relay to either pulse, or KYZ mode, and then select a polarity (active pulse edge) for energy pulses and a pulse width.
2. Select a source accumulator (type of energy) and the pulse rate for your output.
3. Store your new setup to the device.

Programming Analog Inputs

The PM172 can be provided with two optional analog inputs with options for 0-1mA, ± 1 mA, 0-20mA or 4-20mA input currents, depending on the order. Inputs with 0-1mA and ± 1 mA options can accept $\times 200\%$ overload currents, i.e., can actually accommodate currents in the range of 0-2 mA and ± 2 mA.

The meter automatically converts the analog input readings received from the analog-to-digital converter to the user-defined engineering scale and shows the input values in true engineering units, for example, in volts, amps, or degrees, with the desired resolution.

To configure the Analog Inputs in your device, select General Setup from the Meter Setup menu, and then click on the Analog Inputs tab. If you are programming your device online, analog inputs are designated as not available if they are not present in the device.

The available options are described in the following table.

| Option | Range | Description |
|-------------|---|--|
| AI type | 0-1mA ± 1 mA 0-20mA 4-20mA | The analog input type. When connected to the meter, shows the actual type received from the device. When working off-line, select the analog input option corresponding to your meter. |
| Zero scale | -999,999 to 999,999 | Defines the low engineering scale (in primary units) for the analog input corresponding to a lowest (zero) input current (0 or 4 mA) |
| Full scale | -999,999 to 999,999 | Defines the high engineering scale (in primary units) for the analog input corresponding to a highest input current (1 or 20 mA) |
| Dec. Places | 0-3 | The number of decimal digits in a fractional part of the scaled engineering value |
| Value label | | An arbitrary name you can give the analog input value |

| Analog Inputs | | | | | |
|---------------|---------|--------------------|---------------------|-------------|-------------|
| No. | AI Type | Zero Scale (0/4mA) | Full Scale (1/20mA) | Dec. Places | Value Label |
| 1 | +/-1 mA | 0.0 | 144.0 | 1 | V1 |
| 2 | +/-1 mA | 0.00 | 400.00 | 2 | I1 |
| 3 | N/A | ---- | ---- | ---- | ---- |
| 4 | N/A | ---- | ---- | ---- | ---- |
| 5 | N/A | ---- | ---- | ---- | ---- |
| 6 | N/A | ---- | ---- | ---- | ---- |
| 7 | N/A | ---- | ---- | ---- | ---- |
| 8 | N/A | ---- | ---- | ---- | ---- |
| 9 | N/A | ---- | ---- | ---- | ---- |
| 10 | N/A | ---- | ---- | ---- | ---- |
| 11 | N/A | ---- | ---- | ---- | ---- |
| 12 | N/A | ---- | ---- | ---- | ---- |
| 13 | N/A | ---- | ---- | ---- | ---- |
| 14 | N/A | ---- | ---- | ---- | ---- |
| 15 | N/A | ---- | ---- | ---- | ---- |
| 16 | N/A | ---- | ---- | ---- | ---- |

Always save your analog inputs setup to the site database in order to keep the labels you give the analog inputs. They are not stored in your device.

Scaling Non-directional Analog Inputs

For non-directional analog inputs with the 0-1mA, 0-20mA and 4-20mA current options, provide both zero and full engineering scales. Each of the scales operates independently.

Scaling ± 1 mA Analog Inputs

For directional ± 1 mA analog inputs, you should provide only the engineering scale for the +1 mA input current. The engineering scale for the 0 mA input current is always equal to zero. The device does not allow you to access this setting. Whenever the direction of the input current is changed to negative, the device automatically uses your full engineering scale settings for +1 mA with a negative sign.

Scaling Analog Inputs for 0-2 mA and ± 2 mA

The input scales for 0-1 mA and ± 1 mA analog inputs are always programmed for 0 mA and +1 mA regardless of the desired input range. If you want to use the entire input range of 2 mA or ± 2 mA, set the analog input scales in your device as follows:

0-2 mA: set the 1 mA scale to 1/2 of the required full scale output for uni-directional parameters, and set the 0 mA scale to the negative full scale and the 1 mA scale to zero for bi-directional parameters.

± 2 mA: set the 1 mA scale to 1/2 of the required full-scale output for both uni-directional and bi-directional parameters.

For example, to convert voltage readings from the analog transducer that transmits them in the range of 0 to 2 mA to the range 0 to 120V, set the full range for the +1 mA analog input to 60V; then the 2 mA reading is scaled to 120V.

Programming Analog Outputs

The meter can be ordered with two optional analog outputs with options for 0-1mA, ± 1 mA, 0-20mA or 4-20mA output currents.

The 0-1mA and ± 1 mA current outputs provide a 100% overload, and actually output currents up to 2 mA and ± 2 mA whenever the output value exceeds the engineering scale set for the 1 mA or ± 1 mA.

To configure the Analog Outputs in your device, select General Setup from the Meter Setup menu, and then click on the Analog Outputs tab. If you are programming your device online, analog outputs are designated as not available if they are not present in the device.

The available analog output options are described in the following table.

| Option | Range | Description |
|------------------|---|---|
| AO type | 0-1mA ± 1 mA 0-20mA 4-20mA | The analog output type. When connected to the meter, shows the actual AO type read from the device. When working off-line, select the analog output option corresponding to your meter. |
| Output parameter | See Appendix B | Selects the measured parameter to be transmitted through the analog output channel. |
| Zero scale | | Defines the low engineering scale (in primary units) for the analog output corresponding to a lowest (zero) output current (0 or 4 mA) |
| Full scale | | Defines the high engineering scale (in primary units) for the analog output corresponding to a highest output current (1 or 20 mA) |

The screenshot shows the 'Analog Outputs' configuration window. It features a table with 16 rows and 5 columns: No., AO Type, Output parameter, Zero Scale (0/4 mA), and Full Scale (1/20 mA). The first two rows are configured, while the rest are set to 'N/A'. Below the table are buttons for 'Open', 'Save as...', 'Clear', 'Print', 'Send', and 'Receive'. At the bottom are 'OK', 'Cancel', 'Apply', and 'Help' buttons.

| No. | AO Type | Output parameter | Zero Scale (0/4 mA) | Full Scale (1/20 mA) |
|-----|---------|------------------|---------------------|----------------------|
| 1 | 0-20 mA | V1/12 RT | 0.0 | 144.0 |
| 2 | 0-20 mA | PF RT | -0.000 | 0.000 |
| 3 | N/A | ---- | ---- | ---- |
| 4 | N/A | ---- | ---- | ---- |
| 5 | N/A | ---- | ---- | ---- |
| 6 | N/A | ---- | ---- | ---- |
| 7 | N/A | ---- | ---- | ---- |
| 8 | N/A | ---- | ---- | ---- |
| 9 | N/A | ---- | ---- | ---- |
| 10 | N/A | ---- | ---- | ---- |
| 11 | N/A | ---- | ---- | ---- |
| 12 | N/A | ---- | ---- | ---- |
| 13 | N/A | ---- | ---- | ---- |
| 14 | N/A | ---- | ---- | ---- |
| 15 | N/A | ---- | ---- | ---- |
| 16 | N/A | ---- | ---- | ---- |

When you select an output parameter for the analog output channel, the default engineering scales are set automatically. They represent the maximum available scales. If the parameter actually covers a lower range, you can change the scales to provide a better resolution on the analog outputs.

Scaling Non-directional Analog Outputs

When programming scales for non-directional analog outputs with a 0-1mA, 0-20mA or 4-20mA current option, you can change both zero and full engineering scales for any parameter. The engineering scale need not be symmetrical.

Scaling Directional Power Factor

The engineering scale for the signed power factor emulates analog power factor meters. The power factor scale is -0 to +0 and is symmetrical with regard to ± 1.000 ($-1.000 \equiv +1.000$). Negative power factor is scaled as -1.000 minus measured value, and non-negative power factor is scaled as +1.000 minus measured value. To define the entire power factor range from -0 to +0, the default scales are specified as -0.000 to 0.000.

Scaling ± 1 mA Analog Outputs

Programming engineering scales for directional ± 1 mA analog outputs depends on whether the output parameter represents unsigned (as volts and amps) or signed (as powers and power factor) values.

If the output value is unsigned, you can change both zero and full engineering scales.

If the parameter represents a signed (directional) value, you should provide only the engineering scale for the +1 mA output current. The engineering scale for the 0 mA output current is always equal to zero for all values except the signed power factor, for which it is set to 1.000 (see "Scaling Directional Power Factor" above). The device does not allow you access to this setting if the parameter is directional. Whenever the sign of the output parameter is changed to negative, the device automatically uses your full engineering scale settings for +1 mA with a negative sign.

Scaling Analog Outputs for 0-2 mA and ± 2 mA

The output scales for 0-1 mA and ± 1 mA analog outputs are programmed for 0 mA and +1 mA regardless of the desired output current range. To use the entire output range of 2 mA or ± 2 mA, set the analog output scales in your device as follows:

0-2 mA: set the 1 mA scale to 1/2 of the required full scale output for uni-directional parameters, and set the 0 mA scale to the negative full scale and the 1 mA scale to zero for bi-directional parameters.

± 2 mA: set the 1 mA scale to 1/2 of the required full-scale output for both uni-directional and bi-directional parameters.

For example, to provide the 0 to 2 mA output current range for volts measured by the meter in the range of 0 to 120V, set the 1 mA scale to 60V; then the 120V reading will be scaled to 2 mA.

Programming the Analog Expander

Your meter can support up to two analog expanders that are connected through a serial RS-422 interface to the meter port COM2. Each expander has its own address 0 or 1 on the serial interface and provides 8 analog channels with options for 0-1mA, ± 1 mA, 0-20mA or 4-20mA output currents.

To configure the Analog Expander outputs in your device, select General Setup from the Meter Setup menu, and then click on the Analog Expander tab.

| Channel | Output parameter | Zero Scale (0/4 mA) | Full Scale (1/20 mA) |
|---------|------------------|---------------------|----------------------|
| 1 | V1/I12 RT | 0 | 1437 |
| 2 | V2/I23 RT | 0 | 1437 |
| 3 | V3/I31 RT | 0 | 1437 |
| 4 | I1 RT | 0.00 | 800.00 |
| 5 | I2 RT | 0.00 | 800.00 |
| 6 | I3 RT | 0.00 | 800.00 |
| 7 | NONE | ---- | ---- |
| 8 | NONE | ---- | ---- |
| 9 | NONE | ---- | ---- |
| 10 | NONE | ---- | ---- |
| 11 | NONE | ---- | ---- |
| 12 | NONE | ---- | ---- |
| 13 | NONE | ---- | ---- |
| 14 | NONE | ---- | ---- |
| 15 | NONE | ---- | ---- |
| 16 | NONE | ---- | ---- |

The expanded analog outputs are enumerated in the following manner: analog output channels 1 through 8 are associated with the analog expander with address 0, while channels 9 through 16 are associated with the analog expander with address 1.

The available analog expander outputs options are described in the following table.

| Option | Range | Description |
|------------------|----------------|--|
| Output parameter | See Appendix B | Selects the measured parameter to be transmitted through the analog output channel. |
| Zero scale | | Defines the low engineering scale (in primary units) for the analog output corresponding to a lowest (zero) output current (0 or 4 mA) |
| Full scale | | Defines the high engineering scale (in primary units) for the analog output corresponding to a highest output current (1 or 20 mA) |

Before entering the setup dialog, ensure that you selected the correct analog current option for your expander on the Instrument Setup tab in the Tools/Configuration dialog. For scaling output parameters, see “Programming Analog Outputs” above.

 Analog expander outputs are not operational until you globally enable the analog expander option in your meter through the Device Options menu.

Using Counters

The meter provides four six-digit counters that count different events.

To configure the device counters, select General Setup from the Meter Setup menu, and then click on the Pulse/Event Counters tab.

Each counter is independently linked to any digital input and count input pulses with a programmable scale factor. Each counter can also be incremented in response to any internal or external event, checked and cleared through the Control Setpoints.

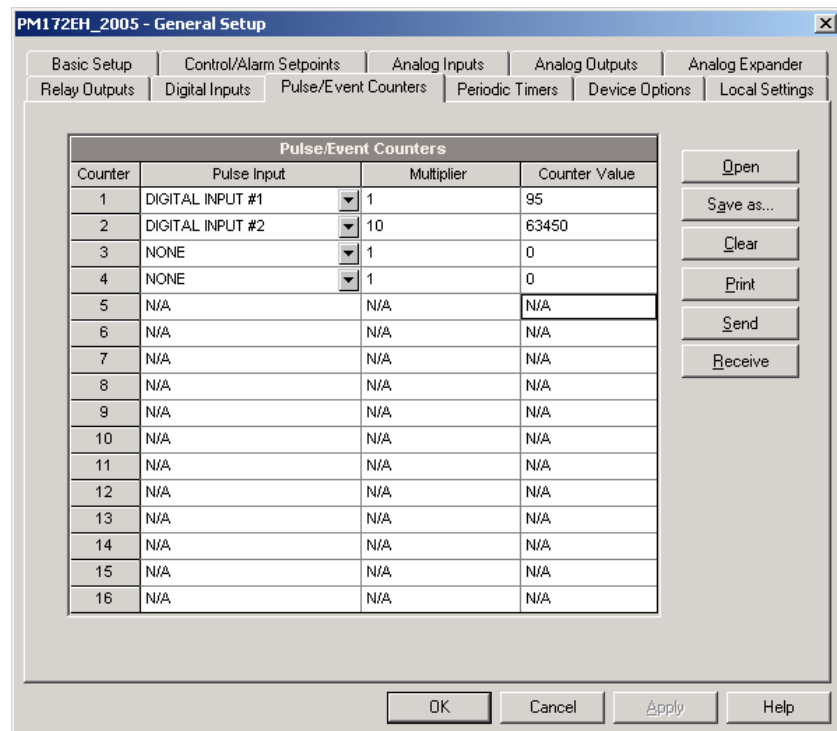

The following table lists available options.

| Option | Range | Default | Description |
|-------------|---------------|---------|--------------------------------------|
| Pulse Input | None, DI1-DI2 | None | Links a digital input to the counter |

| Option | Range | Default | Description |
|---------------|--------|---------|---|
| Multiplier | 1-9999 | 1 | The value added to the counter when a pulse is detected on the pulse source input |
| Counter Value | | | Displays the present counter contents |

You can preset a counter to a desired value or clear it through this dialog without affecting the counter setup. Check the Online button on the PAS toolbar before entering the setup dialog, type in the desired value into the Counter Value box, and then click Send.

Using Periodic Timers

The PM172E and PM172EH provide two programmable interval timers that can be used for periodic recording and triggering operations on a time basis through the Control Setpoints. When a pre-programmed timer interval expires, the timer generates an internal event that can trigger any setpoint (see "Using Alarm/Control Setpoints").

To configure the device timers, select General Setup from the Meter Setup menu, and then click on the Periodic Timers tab.

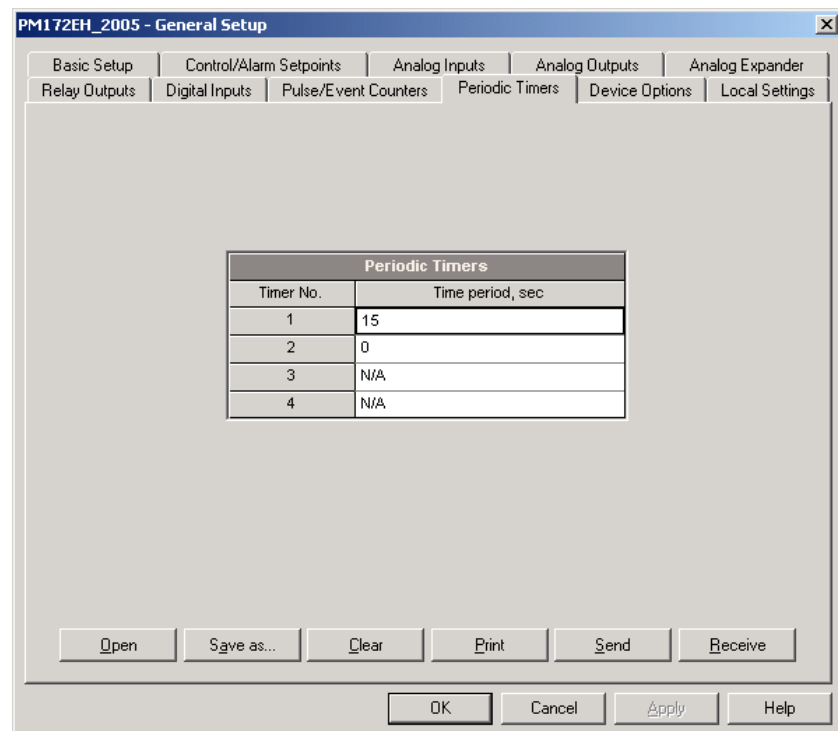

To run a periodic timer, specify a non-zero time period for the timer. The time period can be set from 1 to 9999 seconds.

To stop a timer, set the time period to zero.

Using Control Setpoints

The PM172 has an embedded logical controller that runs different actions in response to user-defined internal and external events. Unlike a PLC, the meter uses a simplified programming technique based on setpoints that allows the user to define a logical expression based on measured analog and digital values that produce a required action.

The meter provides 16 control setpoints with programmable operate and release delays. Each setpoint evaluates a logical expression with up to four arguments using OR/AND logic. Whenever an expression is evaluated as “true”, the setpoint performs up to four concurrent actions that can send a command to the output relays, increment or decrement a counter, or trigger a recorder.

The logical controller provides very fast response to events. The scan time for all setpoints is 1 cycle time (16.6 ms at 60Hz and 20 ms at 50/400 Hz).

To program the setpoints, select General Setup from the Meter Setup menu, and then click on the Control/Alarm Setpoints tab.

The available setpoint options are described in the following table.

| Option | Range | Description |
|-------------------|----------------|--|
| Triggers | | |
| OR/AND | OR, AND | The logical operator for the trigger |
| Trigger parameter | See Appendix C | The trigger parameter that is used as an argument in the logical expression |
| Operate limit | | The threshold (in primary units) at which the conditional expression would be evaluated to true. Not applicable for digital triggers. |
| Release limit | | The threshold (in primary units) at which the conditional expression would be evaluated to false. Defines the hysteresis for analog triggers. Not applicable for digital triggers. |
| Actions | | |
| Action | See Appendix C | The action performed when the setpoint expression is evaluated to true (the setpoint is in operated state) |
| Delays | | |
| Operate delay | 0.1-999.9 sec | The time delay before operation when the operate conditions are fulfilled |
| Release delay | 0.1-999.9 sec | The time delay before release when the release conditions are fulfilled |

PM172EH_2005 - General Setup

Relay Outputs | Digital Inputs | Pulse/Event Counters | Periodic Timers | Device Options | Local Settings

Basic Setup | **Control/Alarm Setpoints** | Analog Inputs | Analog Outputs | Analog Expander

Setpoint No. 2

| Triggers | | | | |
|----------|--------|-------------------|---------------|---------------|
| No. | OR/AND | Trigger Parameter | Operate limit | Release limit |
| 1 | OR | STAT INP #1 ON | NONE | NONE |
| 2 | OR | LO VOLT RT | 14000 | 14500 |
| 3 | OR | HI AMPS AVR | 450 | 420 |
| 4 | OR | NONE | NONE | NONE |

| Actions | |
|---------|------------------|
| 1 | OPERATE RELAY #1 |
| 2 | EVENT LOG |
| 3 | DATA LOG #3 |
| 4 | WAVEFORM LOG #1 |

| Delays, sec | |
|---------------|-----|
| Operate delay | 3.0 |
| Release delay | 5.0 |

Open Save as... Clear Clear All Print Send Receive

OK Cancel Apply Help

Setpoint #1 is factory preset to provide standard periodic data logs on a 15-minute time basis. It is linked to the device clock and runs data logs #1 and #2 at 15-minute boundaries of an hour.

Using Logical Expressions

Logical operators OR/AND are treated in a simplified manner. They have no specific priority or precedence rules.

Any trigger condition bound to the logical expression by the OR operator and evaluated as “true” will override any preceding condition evaluated as “false”. Similarly, any trigger condition evaluated as “false” and bound by the AND operator will override any condition evaluated before it as “true”.

To avoid confusion, it is recommended not to alternate different logical operators in one expression. Instead, bring all conditions that use the same logical operator together at one side of the expression, and the others - at the opposite side.

To explicitly override all other conditions with the critical trigger, put it at the end of the expression using the OR operator if you want the setpoint to be operated anyway when the trigger condition is asserted, and with the AND operator, if the setpoint should not be operated while the critical trigger is not asserted.

Using Numeric Triggers

For numeric (analog) triggers, a setpoint allows you to specify two thresholds for each trigger to provide hysteresis (dead band) for setpoint operations. The Operate Limit defines the operating threshold, and the second Release Limit defines the release threshold for the trigger. The trigger thresholds are specified in primary units.

If you do not want to use hysteresis for the trigger, set the Release Limit to the same as the Operate Limit.

Using Binary Triggers

Binary (digital) triggers, like digital inputs, relays, or internal static and pulsed events, are tested for ON (closed/set) or OFF (open/cleared) status.

The binary events are divided into two types: static events and pulsed events. Static events are level-sensitive events. A static event is asserted all the time while the corresponding condition exists. Examples are digital inputs, relays and event flags.

Pulsed events are edge-sensitive events with auto-reset. A pulsed event is generated for a trigger only once when a positive transition edge is detected on the trigger input. The examples of pulsed events are pulse inputs (transition pulses on the digital inputs), internal pulsed events (energy pulses and time interval pulses), and events generated by the interval timers. The logical controller automatically clears pulsed events at the end of each scan, so that triggers that used pulsed events are prevented from being triggered by the same event once again.

Using Event Flags

The PM172EH provides 8 common binary flags, called event flags, which can be individually set, cleared and tested through setpoints and via communications.

Event flags can be used in different applications, for example, to transfer events between setpoints in order to expand a logical expression or a list of actions that have to be done for a specific event, or to externally trigger setpoint actions from the SCADA system or from a PLC through communications.

Using Interval Timers

The PM172E and PM172EH provide two interval timers that are commonly used for periodic recording of interval data at the time of the fault or in the presence of other events detected by a setpoint. The timers can be

programmed to generate periodic events at user-defined intervals (see “Using Periodic Timers”).

Interval timers are not synchronized with the clock. When you run a timer, it generates a pulsed event that can trigger a setpoint if you have put the timer into a list of the setpoint triggers. When the setpoint event is asserted, the timer is restarted, and then generates the next event when the timer interval expires.

If you want to record interval data at predefined intervals without linking to other events, just select a timer as a setpoint trigger and specify a data log file you want to use for recording, in the setpoint actions list. If you want the periodic data to be recorded in presence of a specific event, select triggers that will identify your event, and then add the timer at the end of the trigger list using the AND operator.

Using Time Triggers

If you want the setpoint actions to be synchronized with the clock, for example, to provide synchronous recording interval data each 15 minutes or each hour, or to output time pulses through relay contacts, use the time triggers that generate static events synchronized to the device clock.

You can exercise the default setting for Setpoint #1 in your device as an example of using time triggers. The setpoint is pre-programmed for data profiling at 15-minute intervals using data logs #1 and #2.

Using the Voltage Disturbance Trigger

The PM172EH provides the voltage disturbance trigger (found under the VOLT DISTURB name) that detects all types of the voltage waveshape faults on any phase caused by fast transient voltages. You can use it for recording disturbances.

The operate threshold for the voltage disturbance trigger defines the maximum allowable voltage deviation from the steady-state level above which the device will declare a waveshape fault. By default, it is specified as a percent of the nominal device voltage. If you wish to use volts units instead, you can select the desired voltage disturbance units from the Preferences tab in the Tools/Options/Preferences dialog.

 The voltage waveforms in 4LN3, 4LL3, 3LN3, 3LL3, 3BLN3 and 3BLL3 wiring modes represent line-to-neutral voltages; otherwise, they will be line-to-line voltages. Take it into account when specifying the nominal device voltage that is used as a reference for the disturbance trigger.

The trigger does not respond to slow voltage variations whenever the voltage rise above or drop below the specified threshold takes longer than 1 cycle time.

Delaying Setpoint Operations

Two optional delays can be added to each setpoint to extend monitoring setpoint triggers for a longer time before making a decision on whether the expected event occurred or not. When a delay is specified, the logical controller will change the setpoint status only if all conditions are asserted for a period at least as long as the delay time.

Note that you cannot use delays with pulsed events since they are cleared immediately and will no longer exist on the next setpoint scan.

Using Setpoint Events and Actions

When a setpoint status changes, i.e., a setpoint event is either asserted or de-asserted, the following happens in your device:

1. The new setpoint status is logged to the setpoint status register that can be monitored through communications from the SCADA system or from a programmable

controller in order to give an indication on the expected event.

2. The operated setpoint status is latched to the setpoint alarm latch register accessible through communications. The register holds the last setpoint alarm status until it is explicitly cleared through communications.
3. Up to four programmable actions can be performed in sequence on setpoint status transition when a setpoint event is asserted.

Generally, setpoint actions are performed independently for each setpoint and can be repeated a number of times for the same target. The exceptions are relay operations, data logging and waveform logging that are shared for each separate target between all setpoints using an OR scheme.

A relay output is operated when one of the setpoints linked to the relay is activated and will stay in the operated state until all of these setpoints are released (except for latched relays that require a separate release command to be deactivated).

Data logging and waveform logging directed to the same file are done once for the first setpoint among those that specify the same action, guaranteeing that there will not be repeated records related to the same time.

Recording Setpoint Events

Time-tagged setpoint events can be recorded to the device Event Log if you put a corresponding action into the setpoint action list. The Event Recorder will log any setpoint transition event: both when the setpoint is operated, and when it is released. The Event Recorder will put into a log file a separate record for each active trigger caused a setpoint status transition, and a separate record for each action done on the setpoint activation (except for data logging actions that are not recorded to the Event Log).

Configuring Summary Energy and TOU Registers

The PM172E and PM172EH provide 8 total (summary) energy and 8 concurrent tariff energy and maximum demand registers that can be linked to any internal energy source or to any external pulse source that delivers pulses through the device digital inputs.

The meter tariff structure supports 8 different tariffs using an arbitrary tariff schedule. A total of 4 types of days and 4 seasons are supported with up to eight tariff changes per day.

The meter can provide automatic daily profile recording for total and tariff energy and maximum demand registers.

By default, the billing registers in your meter and the tariff system are not operational. To activate the summary/tariff registers or to change the profile for the first billing register:

1. Link the billing registers to the respective energy sources, and then configure the options for these registers like whether the only totalization or both total and tariff registers would be used, and whether daily profiling should be enabled for the energy usage and maximum demand registers.
2. Configure the daily tariff schedule using the TOU daily profiles for all types of days and seasons.
3. Configure the season tariff schedule using the TOU calendar.

Setting up Total and Tariff Registers

To configure the device total (summary) and TOU registers, select Energy/TOU from the Meter Setup menu.

PM172EH_2005 - Energy/TOU Setup

Energy/TOU Registers | TOU Daily Profiles | TOU Calendar

| Summary/TOU Registers | | | | | |
|-----------------------|-------------------------------------|-------------------------------------|--------------------------|-------------------------------------|-------|
| Reg. | TOU | Use Prof | Dmd Prof | Sum Prof | Units |
| 1 | <input checked="" type="checkbox"/> | <input checked="" type="checkbox"/> | <input type="checkbox"/> | <input checked="" type="checkbox"/> | kWh |
| 2 | <input checked="" type="checkbox"/> | <input checked="" type="checkbox"/> | <input type="checkbox"/> | <input checked="" type="checkbox"/> | ---- |
| 3 | <input type="checkbox"/> | <input type="checkbox"/> | <input type="checkbox"/> | <input type="checkbox"/> | kWh |
| 4 | <input type="checkbox"/> | <input type="checkbox"/> | <input type="checkbox"/> | <input type="checkbox"/> | kvarh |
| 5 | <input type="checkbox"/> | <input type="checkbox"/> | <input type="checkbox"/> | <input type="checkbox"/> | kVAh |
| 6 | <input type="checkbox"/> | <input type="checkbox"/> | <input type="checkbox"/> | <input type="checkbox"/> | m3 |
| 7 | <input type="checkbox"/> | <input type="checkbox"/> | <input type="checkbox"/> | <input type="checkbox"/> | CF |
| 8 | <input type="checkbox"/> | <input type="checkbox"/> | <input type="checkbox"/> | <input type="checkbox"/> | CCF |
| 9 | <input type="checkbox"/> | <input type="checkbox"/> | <input type="checkbox"/> | <input type="checkbox"/> | ---- |
| 10 | <input type="checkbox"/> | <input type="checkbox"/> | <input type="checkbox"/> | <input type="checkbox"/> | ---- |
| 11 | <input type="checkbox"/> | <input type="checkbox"/> | <input type="checkbox"/> | <input type="checkbox"/> | ---- |
| 12 | <input type="checkbox"/> | <input type="checkbox"/> | <input type="checkbox"/> | <input type="checkbox"/> | ---- |
| 13 | <input type="checkbox"/> | <input type="checkbox"/> | <input type="checkbox"/> | <input type="checkbox"/> | ---- |
| 14 | <input type="checkbox"/> | <input type="checkbox"/> | <input type="checkbox"/> | <input type="checkbox"/> | ---- |
| 15 | <input type="checkbox"/> | <input type="checkbox"/> | <input type="checkbox"/> | <input type="checkbox"/> | ---- |
| 16 | <input type="checkbox"/> | <input type="checkbox"/> | <input type="checkbox"/> | <input type="checkbox"/> | ---- |

| Register Source List | | | |
|----------------------|--------------|------------|--------|
| No. | Source Input | Multiplier | Target |
| 1 | kWh IMPORT | 1.000 | Reg #1 |
| 2 | ---- | 1.000 | Reg #2 |
| 3 | kWh IMPORT | ---- | ---- |
| 4 | kWh EXPORT | ---- | ---- |
| 5 | kvarh IMPORT | ---- | ---- |
| 6 | kvarh EXPORT | ---- | ---- |
| 7 | kVAh TOTAL | ---- | ---- |
| 8 | DI1 | ---- | ---- |
| 9 | DI2 | ---- | ---- |
| 10 | ---- | ---- | ---- |
| 11 | ---- | ---- | ---- |
| 12 | ---- | ---- | ---- |
| 13 | ---- | ---- | ---- |
| 14 | ---- | ---- | ---- |
| 15 | ---- | ---- | ---- |
| 16 | ---- | ---- | ---- |

Open Save as... Default Print Send Receive

OK Cancel Apply Help

The available options are shown in the following table:

| Parameter | Options | Default | Description |
|------------------------------|--|-----------|--|
| Summary/TOU Registers | | | |
| TOU | Unchecked Checked | Unchecked | Links tariff registers to the selected energy source |
| Use Prof | Unchecked Checked | Unchecked | Enables automatic daily profiling for energy usage registers (both total and tariff registers if TOU is enabled) |
| Dmd Prof | Unchecked Checked | Unchecked | Enables automatic daily profiling for maximum demand registers (both total and tariff registers if TOU is enabled) |
| Sum Prof | Unchecked Checked | Unchecked | Enables daily profiling for summary registers (total of all tariffs) |
| Units | kWh, kvarh, kVAh, m ³ , CF (cubic foot), CCF (hundred cubic feet) | None | The register measurement units. When a register is linked to an internal energy source, it is set automatically. When an external pulse source is used, the user can select a measurement unit for the register. |
| Register Source List | | | |
| Source Input | None kWh Import kWh Export kvarh Import kvarh Export kVAh, DI1-DI2 | None | Links an energy source to the register |
| Multiplier | 0.001 to 100.000 | 1.000 | The multiplication factor for the energy source. |
| Target | Reg#1- Reg#8 | None | Defines the target billing register for the energy source. It is set automatically. |

Configuring the Daily Tariff Schedule

To configure your daily tariff schedule, select Energy/TOU from the Meter Setup menu, and then click on the TOU Daily Profiles tab.

The daily profile setup allows you to specify the daily tariff change points with a 15-minute resolution for 4 seasons using 4 different daily schedules for each season.

To configure your daily profiles:

1. Select the desired season and day type.
2. Select the start time for each tariff change point and the corresponding active tariff number.
3. Repeat the setup for all active profiles.

The first tariff change point is fixed at 00:00 hours, and the last tariff change you specified will be in use until 00:00 hours on the next day.

The energy daily profile log will be automatically configured for the number of active tariffs you defined in the meter TOU daily profile.

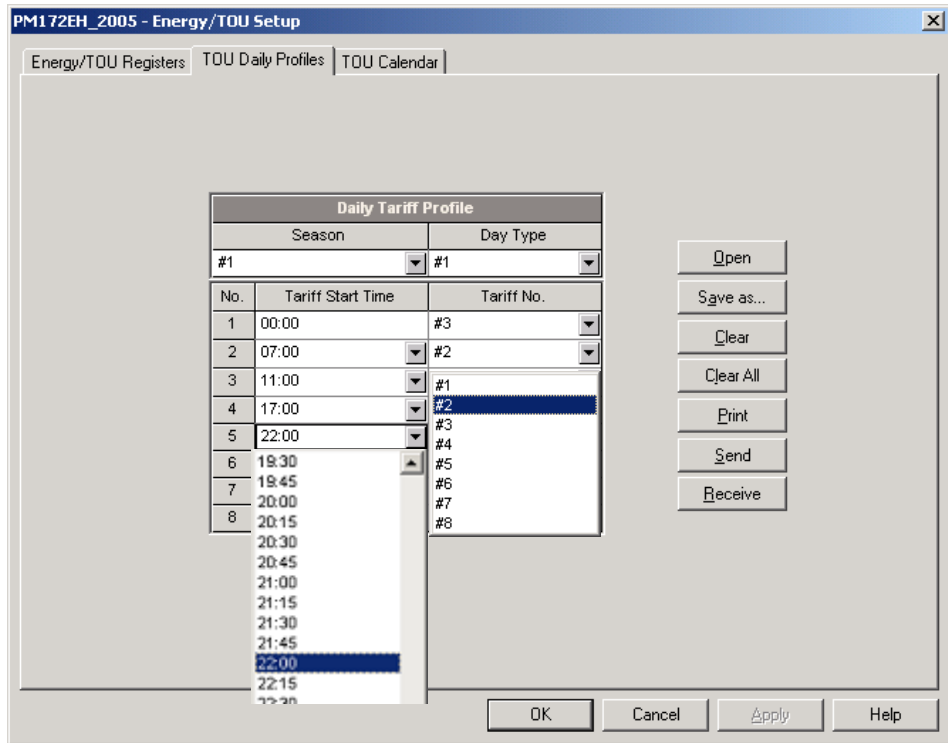

Configuring the Season Tariff Schedule

To configure your season tariff schedule, select Energy/TOU from the Meter Setup menu, and then click on the TOU Calendar tab.

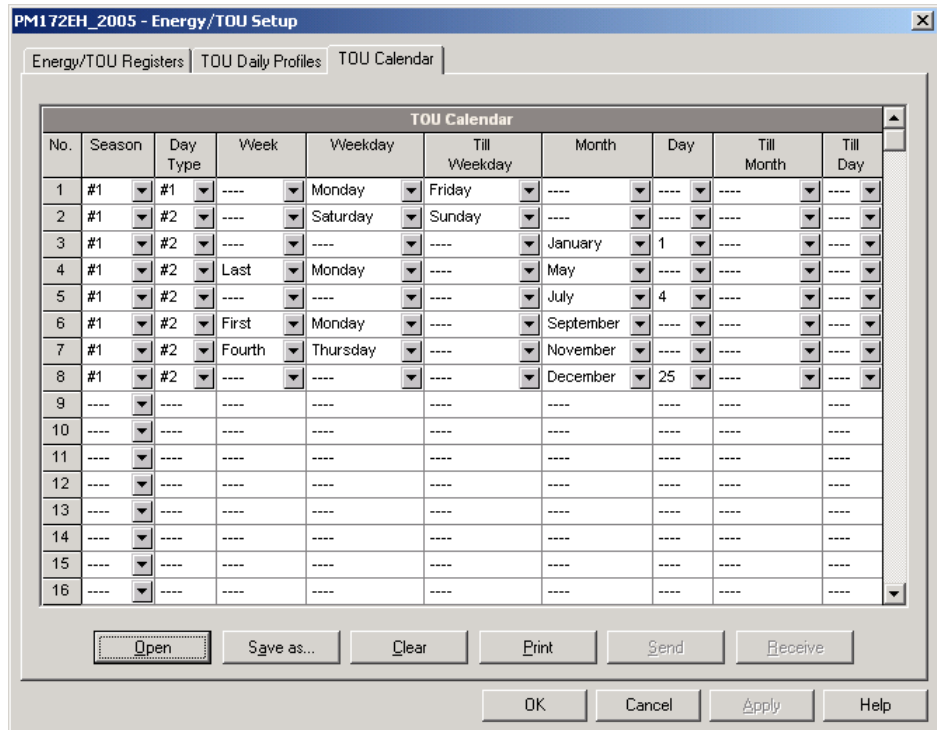

The meter's TOU calendar allows you to configure any tariff schedule based on any possible utility regulation. The calendar itself has 32 entries that allow you to specify profiles for working days and holidays through all seasons in any order that is convenient for you, based on simple intuitive rules. There

are no limitations on how to define your schedule. The meter is able to automatically recognize your settings and to select a proper daily tariff schedule for any day within a year.

The above picture gives you an example of a single-season tariff schedule configured for weekends and the designated U.S.A. holidays.

To configure your season tariff schedule:

1. In the "Season" box, select the season, and in the "Day Type" box, select a day type for this calendar entry.
2. Select the time interval when this daily tariff schedule is effective, based on the start and the end weekdays and, for a multi-season schedule, on the start and the end month for the selected season. It does not matter which order of weekdays or months you select: the meter can recognize the correct order by itself.
3. For exception days like designated holidays, select a specific day either by specifying a day and month, or by selecting a month, a week and a weekday within the month.

Configuring Recorders

The PM172E and PM72EH are provided with a 1-Megabyte onboard non-volatile memory for data, event and waveform recording.

Before using recorders, the device memory should be partitioned between log files. The device memory is fully configurable. You can define how much memory to allocate for each log file. If you want to change the factory settings, follow the guidelines in the section below.

Configuring Device Memory

The device memory can be partitioned for a total of 11 log files:

- Event Log
- 8 Data Logs
- 2 Waveform Logs

To view the present device memory settings, select Memory/Log from the Meter Setup menu, and then click on the Log Memory tab.

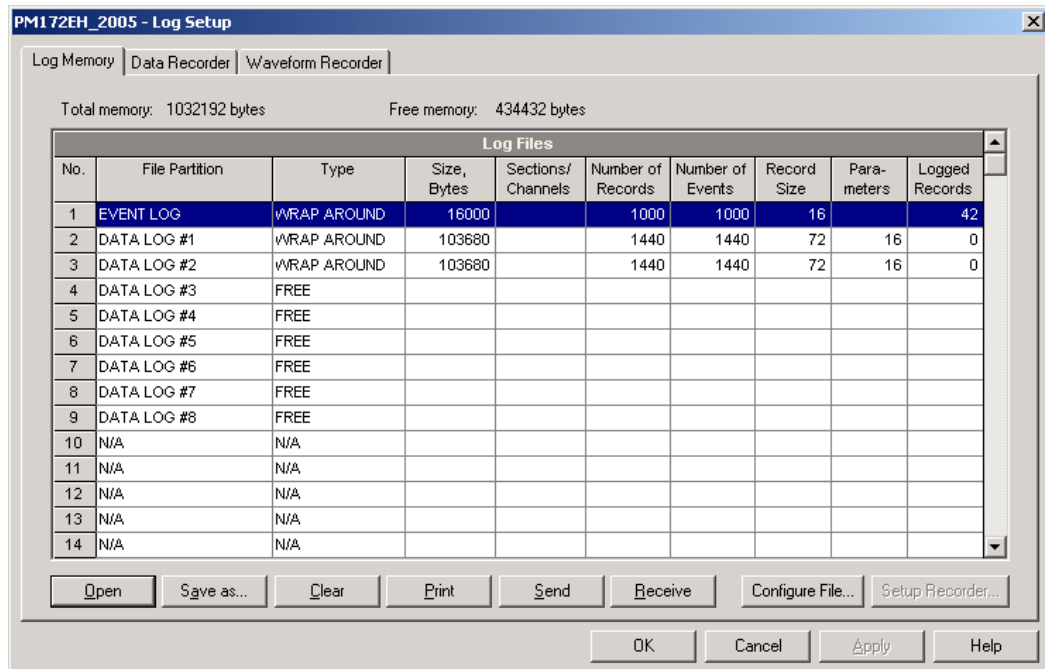

The following table lists available file options.

| Option | Range | Description |
|-------------------|--------------------------------------|--|
| Type | WRAP AROUND NON-WRAP DAILY PRF | Defines the file behavior when it is filled up. WRAP AROUND: recording continues over the oldest records. NON-WRAP: recording is stopped until the file is cleared. DAILY PRF: daily TOU profile data log (only for Data Log #8). |
| Size | | The memory size allocated to the file. Set automatically depending on the size of the records and the number of records in the file. |
| Sections/Channels | 0-14 | The numbers of sections in a multi-section TOU profile data log file, or the number of recording channels in a waveform log file |
| Num. of Records | 0-65535 | Allocates the file memory for predefined number of records |
| Record size | | The size of the file record for a single channel or a section. Set automatically depending on the file and on the number of parameters in the data record |
| Parameters | 0-16 | The number of parameters in a single data record |

Memory is allocated for each file statically when you set up your files and will not change unless you re-organize the files. The meter automatically

performs de-fragmentation of the memory each time you re-organize your files. This helps keep all free memory in one continuous block and thus prevents possible leakage of memory caused by fragmentation.

To change the file properties or to allocate the memory for a new file, double click on the file partition you want to change, select desired parameters for your log, and then click OK. For your reference, the record size and the number of records available for your file are reported in the dialog box.

To delete an existing file partition, click on Delete and then click OK.

The following table shows how to calculate a file size for different log files.

| File | Record Size, Bytes | File Size, Bytes |
|-------------------------|--|---|
| Event Log | 16 | Record size x Number of records |
| Data Log | 8 + 4 x Number of parameters | Record size x Number of records |
| TOU Profile Data Log #8 | 8 + 4 x (Number of season tariffs (+ 1 if the TOU summary register is also ordered)) | Record size x Number of TOU registers x Number of records (x 2 if the maximum demand profile is also ordered) |
| Waveform Log | 1040 (per channel) | Record size x 6 x Number of series (events) x Number of records per series |

For more information on configuring specific files, see “Configuring Data Log Files” and “Configuring Waveform Files” below.

The memory is pre-configured for common data trending and fault recording applications as shown in the following table.

| No. | File | Type | Size, Bytes | Channels | Number of Records | Number of Events | Description |
|-----|-----------------|-------------|-------------|----------|-------------------|------------------|------------------------------|
| 1 | Event log | Wrap around | 16000 | | 1000 | 1000 | |
| 2 | Data log #1 | Wrap around | 103680 | | 1440 | 1440 | Configured for data trending |
| 3 | Data log #2 | Wrap around | 103680 | | 1440 | 1440 | Configured for data trending |
| 18 | Waveform log #1 | Wrap around | 249600 | 6 | 40 | 40 | |
| 19 | Waveform log #2 | Wrap around | 124800 | 6 | 20 | 20 | |

Configuring the Event Recorder

To configure the Event Log file:

1. Double click on the Event Log file partition with the left mouse button.

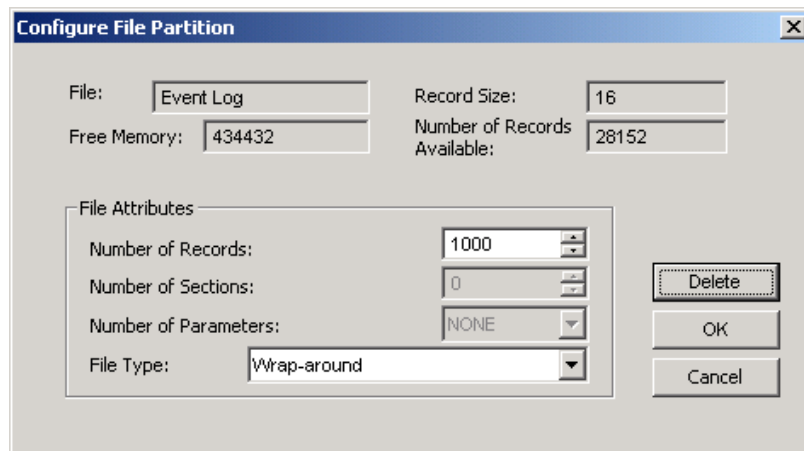

2. Select a file type for your file.
3. Select the maximum number of records you want to be recorded in the file.

- Click OK, and then send your new setup to the meter or save to the device database.

By default, the Event Recorder stores all events related to configuration changes, reset, and device diagnostics. In addition, it records events related to setpoint operations. Each setpoint should be individually enabled for recording to the Event Log.

To log setpoint operations, add the “Event log” action to the setpoint actions list. When a setpoint event happens, the Event Recorder logs all setpoint conditions that caused the event and all setpoint actions performed in response to the event. Logging actions themselves will not be recorded to the Event Log.

Configuring the Data Recorder

The Data Recorder is programmable to record up to 16 data parameters per record in each of 8 data log files. The list of parameters to be recorded to a data log is configured individually for each file.

Conventional Data Log Files

To create a new data log file or re-configure an existing file:

- Double click on the file partition with the left mouse button.

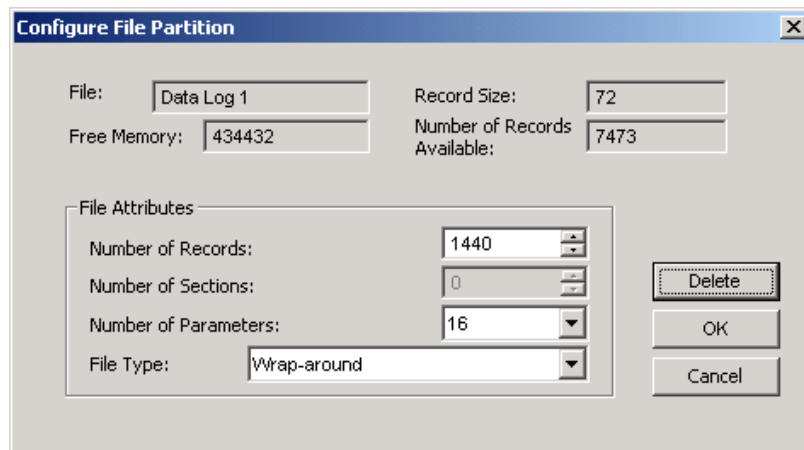

- Select a file type for your file.
- Select the number of parameters you want to be recorded in the file records.
- Select the maximum number of records you want to be recorded in the file.
- Click OK, and then send your new setup to the meter, or save to the device database.
- Highlight the data log file row with the left mouse button, and then click on the “Setup Recorder” button, or click on the “Data Recorder” tab and select the log number corresponding to your file.
- Configure the list of parameters to be recorded in your data log file. You are not allowed to select more parameters than you defined when configuring your file. Refer to Appendix D for a list of available parameters.

For your convenience, PAS will follow your selection and help you to configure a series of the neighboring parameters: when you open the “Group” box for the next parameter, PAS highlights the same group as in your previous selection; if you select this group again, PAS will

automatically update the “Parameter” box with the following parameter in the group.

| Data Log Parameters | | | | | |
|---------------------|----------|-----------|-----|----------|-----------|
| No. | Group | Parameter | No. | Group | Parameter |
| 1 | RT PHASE | V1 | 9 | RT TOTAL | kVA |
| 2 | RT PHASE | V2 | 10 | RT TOTAL | PF |
| 3 | RT PHASE | V3 | 11 | RT PHASE | V1 THD |
| 4 | RT PHASE | I1 | 12 | RT PHASE | V2 THD |
| 5 | RT PHASE | I2 | 13 | RT PHASE | V3 THD |
| 6 | RT PHASE | I3 | 14 | RT PHASE | I1 THD |
| 7 | RT TOTAL | kW | 15 | RT PHASE | I2 THD |
| 8 | RT TOTAL | kvar | 16 | RT PHASE | I3 THD |

8. Add the name for your data log file in the “Name” box. It will appear in the data log reports.
9. Save your new setup to the device database, and send it to the meter.

Factory Preset Periodic Data Logs

Data logs #1 and #2 are factory preset for periodic recording of the standard power quantities as shown in the following table.

| No. | Parameter | No. | Parameter |
|--------------------|----------------------------|-----|--------------------|
| Data Log #1 | | | |
| 1 | V1/V12 | 9 | Total kVA |
| 2 | V2/V23 | 10 | Total PF |
| 3 | V3/V31 | 11 | V1/V12 THD |
| 4 | I1 | 12 | V2/V23 THD |
| 5 | I2 | 13 | V3/V31 THD |
| 6 | I3 | 14 | I1 THD |
| 7 | Total kW | 15 | I2 THD |
| 8 | Total kvar | 16 | I3 THD |
| Data Log #2 | | | |
| 1 | V1/V12 Demand | 9 | KVA Sliding Demand |
| 2 | V2/V23 Demand | 10 | kWh Import |
| 3 | V3/V31 Demand | 11 | kWh Export |
| 4 | I1 Demand | 12 | kvarh Import |
| 5 | I2 Demand | 13 | kvarh Export |
| 6 | I3 Demand | 14 | kVAh |
| 7 | kW Import Sliding Demand | 15 | In |
| 8 | kvar Import Sliding Demand | 16 | Frequency |

TOU Profile Data Log Files

Data Log #8 is configurable to store TOU daily profile log records on a daily basis.

A TOU profile log file is organized as a multi-section file that has a separate section for each TOU energy and maximum demand register. The number of sections is taken automatically from the Summary/TOU Registers setup (see “Configuring Summary and TOU Registers”). If you selected to profile TOU

maximum demands along with energy registers, then the number of sections in the file will be twice the number of the allocated TOU registers.

To configure a TOU daily profile log file:

1. Configure your TOU registers and TOU schedule in the meter before allocating memory for the profile log file (see “Configuring Summary and TOU Registers”).
2. Double click on the DATA LOG #8 partition with the left mouse button.

3. Select the TOU Daily profile file type for your file.
4. Select the number of season tariffs in your TOU schedule. Add one additional parameter if you selected to record the Summary (TOU total) registers as well.
5. Select the maximum number of records you want to be recorded in the file assuming that a new record will be added once a day.
6. Click OK and send your setup to the meter or save to the database.

Configuring the Waveform Recorder

Waveform log files are organized as multi-section files that store data for each recording channel in a separate section. A waveform log file stores 6 channels simultaneously: three voltage and three current channels.

A single waveform record for a channel contains 512 points of the sampled input signal. If a waveform log is configured to record more samples per event than a single record can hold, the waveform recorder stores as many records per event as required to record the entire event. All waveform records related to the event are merged in a series and have the same series number, so that they can be plotted together.

The PM172EH supports two waveform files that record waveforms at two fixed sampling rates:

- Waveform Log #1 - at 32 samples/cycle
- Waveform Log #2 - at 128 samples/cycle

To configure a waveform log file:

1. Double click on a waveform log partition with the left mouse button.
2. Select a file type for your file.
3. Select the maximum number of records you want to be recorded in the file.

The number of records in the waveform log file needed to store one waveform event (series) is defined as follows:

$$\text{Number of Records per Series} = \frac{\text{Sampling Rate (Samples per Cycle)} \times \text{Number of Cycles per Event}}{512}$$

The total number of records you must allocate to store the required number of events (series) is defined as follows:

$$\text{Number of Records} = \text{Number of Records per Series} \times \text{Number of Series}$$

For example, if you want to record a 64-cycle waveform sampled at a rate of 32 samples per cycle, the number of records required for one waveform series would be:

$$\text{Number of Records per Series} = \frac{(32 \times 64)}{512} = 4.$$

If you want to allocate space sufficient to store 20 waveform events (series), you should set up the waveform log file for $4 \times 20 = 80$ records.

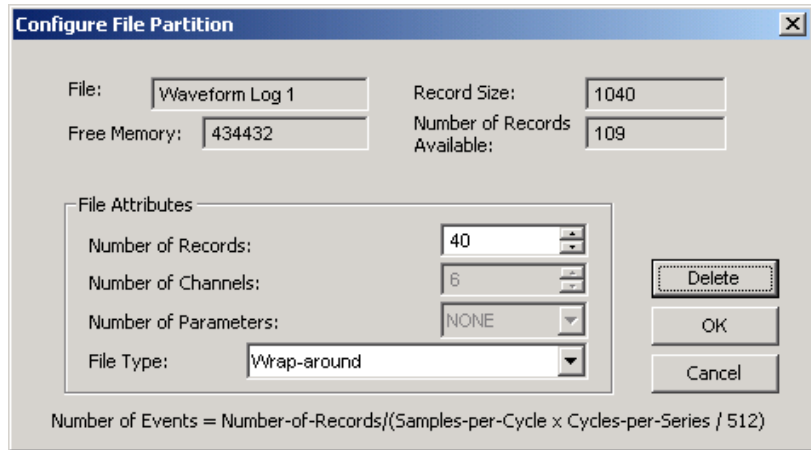

4. Click OK, and send your setup to the meter or save to the database.
5. Click "Setup Recorder", or click on the "Waveform Recorder" tab.

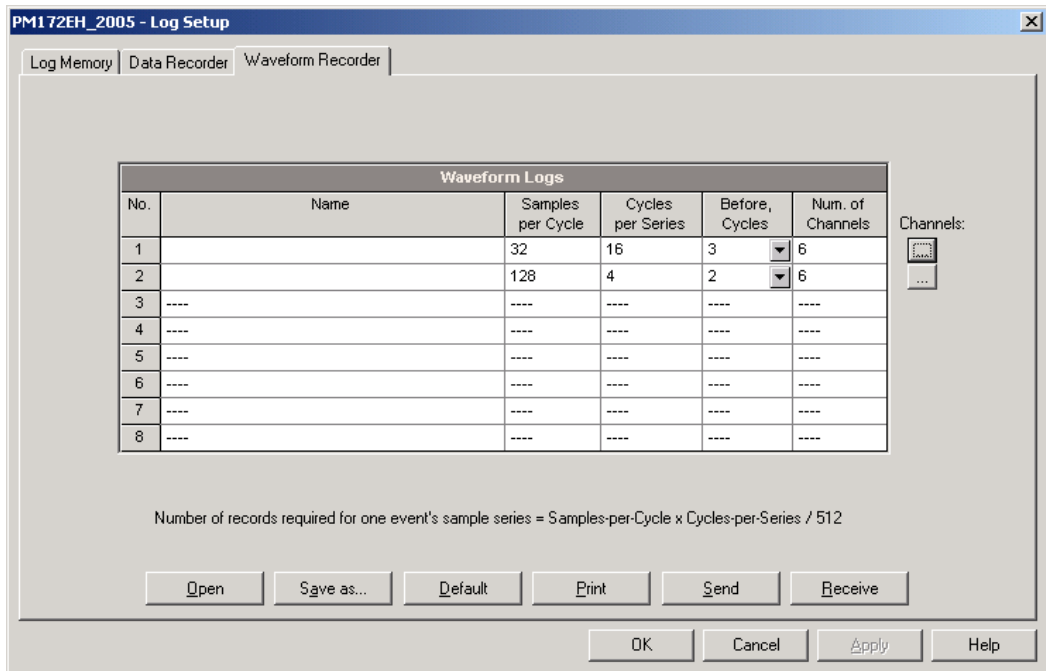

The following table lists available waveform options.

| Option | Format/Range | Description |
|-------------------|--|---|
| Samples per Cycle | 32, for Waveform Log #1 128, for Waveform Log #2 | Fixed for the file |
| Cycles per Series | 16-2560 (32 samples/cycle), 4-640 (128 samples/cycle) | Defines the total duration of the waveform per event/series |
| Before Cycles | 1-20 | Defines the number of cycles to be recorded prior to event |
| Num. of Channels | 6 | Fixed. Shows the number of the simultaneously recorded channels |

6. Select the number of cycles to be recorded prior to the event, and a total number of cycles in the waveform.
7. Add the name for your waveform log file in the "Name" box. It will appear in the waveform reports.
8. Save you waveform setup to the device database, and send it to the meter.

Configuring Communication Protocols

This section describes how to customize protocol options for use with your application software.

Configuring Modbus

Modbus Point Mapping

The PM172 provides 120 user assignable registers in the address range of 0 to 119. You can re-map any register available in the meter to any assignable register so that Modbus registers that reside at different locations may be simply accessed using a single request by re-mapping them to adjacent addresses.

Initially these registers are reserved and none of them points to an actual data register. To build your own Modbus register map:

1. Select Protocol Setup from the Meter Setup menu and click on the Modbus Registers tab.
2. Click on the Default button to cause the assignable registers to reference the actual default meter register 6656 (0 through 119 are not allowable register addresses for re-mapping).
3. Type in the actual addresses you want to read from or write to via the assignable registers. Refer to the PM172 Modbus Reference Guide for a list of the available registers. Notice that 32-bit Modbus registers should always start at an even register address.

The screenshot shows the 'PM172-N - Protocol Setup' window with the 'Modbus Registers' tab selected. The window has several tabs: 'Modbus Registers', 'DNP Options', 'DNP Event Setpoints', and 'DNP Class 0 Points'. The main area is divided into two sections: 'Assignable Registers' and 'Conversion Scales'.

Assignable Registers Table:

| Reg | Addr. [dec] | Reg | Addr. [dec] | Reg | Addr. [dec] | Reg | Addr. [dec] | Reg | Addr. [dec] | Reg | Addr. [dec] |
|-----|-------------|-----|-------------|-----|-------------|-----|-------------|-----|-------------|-----|-------------|
| 0 | 13312 | 20 | 13703 | 40 | 6656 | 60 | 6656 | 80 | 6656 | 100 | 6656 |
| 1 | 13313 | 21 | 13828 | 41 | 6656 | 61 | 6656 | 81 | 6656 | 101 | 6656 |
| 2 | 13314 | 22 | 13829 | 42 | 6656 | 62 | 6656 | 82 | 6656 | 102 | 6656 |
| 3 | 13315 | 23 | 14720 | 43 | 6656 | 63 | 6656 | 83 | 6656 | 103 | 6656 |
| 4 | 13316 | 24 | 14721 | 44 | 6656 | 64 | 6656 | 84 | 6656 | 104 | 6656 |
| 5 | 13317 | 25 | 14722 | 45 | 6656 | 65 | 6656 | 85 | 6656 | 105 | 6656 |
| 6 | 13318 | 26 | 14723 | 46 | 6656 | 66 | 6656 | 86 | 6656 | 106 | 6656 |
| 7 | 13319 | 27 | 14736 | 47 | 6656 | 67 | 6656 | 87 | 6656 | 107 | 6656 |
| 8 | 13320 | 28 | 14737 | 48 | 6656 | 68 | 6656 | 88 | 6656 | 108 | 6656 |
| 9 | 13321 | 29 | 2305 | 49 | 6656 | 69 | 6656 | 89 | 6656 | 109 | 6656 |
| 10 | 13322 | 30 | 2306 | 50 | 6656 | 70 | 6656 | 90 | 6656 | 110 | 6656 |
| 11 | 13323 | 31 | 6656 | 51 | 6656 | 71 | 6656 | 91 | 6656 | 111 | 6656 |
| 12 | 13324 | 32 | 6656 | 52 | 6656 | 72 | 6656 | 92 | 6656 | 112 | 6656 |
| 13 | 13696 | 33 | 6656 | 53 | 6656 | 73 | 6656 | 93 | 6656 | 113 | 6656 |
| 14 | 13697 | 34 | 6656 | 54 | 6656 | 74 | 6656 | 94 | 6656 | 114 | 6656 |
| 15 | 13698 | 35 | 6656 | 55 | 6656 | 75 | 6656 | 95 | 6656 | 115 | 6656 |
| 16 | 13699 | 36 | 6656 | 56 | 6656 | 76 | 6656 | 96 | 6656 | 116 | 6656 |
| 17 | 13700 | 37 | 6656 | 57 | 6656 | 77 | 6656 | 97 | 6656 | 117 | 6656 |
| 18 | 13701 | 38 | 6656 | 58 | 6656 | 78 | 6656 | 98 | 6656 | 118 | 6656 |
| 19 | 13702 | 39 | 6656 | 59 | 6656 | 79 | 6656 | 99 | 6656 | 119 | 6656 |

Conversion Scales Table:

| Raw Scale Low | Raw Scale High | 32-bit Analog Reg | 32-bit Counters | 32-bit Energy Reg |
|---------------|----------------|-------------------|-----------------|-------------------|
| 0 | 9999 | Integer | Integer | Integer |

Buttons on the right side of the window: Open, Save as..., Default, Print, Send, Receive. Buttons at the bottom: OK, Cancel, Apply, Help.

4. Click Send to download your setup to the meter.

Configuring DNP3

DNP Options can be changed both via DNP3 and Modbus. Refer to the PM172 DNP3 Reference guide for information on the protocol implementation and a list of the available data points.

DNP Options

To view or change the factory-set DNP options, select Protocol Setup from the Meter Setup menu and click on the DNP Options tab.

The screenshot shows the 'PM174 - Protocol Setup' window with the 'DNP Options' tab selected. The window is divided into four main sections:

- Binary Inputs (BI):**
 - Number of BI to generate events: 0
 - Binary Input Object: Single-bit
 - Binary Input Change Event Object: vWith Time
- Analog Inputs (AI):**
 - Number of AI to generate events: 32
 - Analog Input Object: 16-bit -Flag
 - Analog Input Change Event Object: 16-bit +Time
 - Frozen Analog Input Object: N/A
 - Frozen Analog Change Event Object: N/A
- Binary Counters (BC):**
 - Number of BC to generate events: 0
 - Binary Counter Object: 32-bit -Flag
 - Binary Counter Change Event Object: 32-bit +Time
 - Frozen Binary Counter Object: 32-bit -Flag
 - Frozen Counter Change Event Object: N/A
- DNP General Options:**
 - 16-bit AI Scaling: Enabled
 - 16-bit BC Scaling: x1
 - Re-mapping Event Points: Disabled
 - SBO Timeout, sec: 10
 - Time Sync Period, sec: 86400
 - Multi Fragment Interval, ms: 50

At the bottom of the dialog, there are buttons for 'Open', 'Save as...', 'Default', 'Print', 'Send', 'Receive', 'OK', 'Cancel', 'Apply', and 'Help'.

The following table describes available DNP options. Refer to the DNP3 Data Object Library document available from the DNP User's Group on the DNP3 object types.

| Parameter | Options | Default | Description |
|----------------------------------|--|--------------|--|
| Binary Inputs (BI) | | | |
| Number of BI to Generate events | 0-64 ³ | 0 | The total number of BI change event points for monitoring |
| Binary Input Object | Single-bit With Status | Single-bit | The default BI object variation for requests with qualifier code 06 when no specific variation is requested |
| Binary Input Change Event Object | Without Time With Time | With Time | The default BI change event object variation for requests with qualifier code 06 when no specific variation is requested |
| Analog Inputs (AI) | | | |
| Number of AI to Generate events | 0-64 ³ | 32 | The total number of AI change event points for monitoring |
| Analog Input Object | 32-bit 32-bit -Flag 16-bit 16-bit -Flag | 16-bit -Flag | The default AI object variation for requests with qualifier code 06 when no specific variation is requested |

| Parameter | Options | Default | Description |
|------------------------------------|--|--------------|--|
| Analog Input Change Event Object | 32-bit -Time 32-bit +Time 16-bit -Time 16-bit +Time | 16-bit +Time | The default AI change event object variation for requests with qualifier code 06 when no specific variation is requested |
| Binary Counters (BC) | | | |
| Number of BC to Generate events | 0-64 ³ | 0 | The total number of BC change event points for monitoring |
| Binary Counter Object | 32-bit +Flag 32-bit -Flag 16-bit +Flag 16-bit -Flag | 32-bit -Flag | The default BC object variation for requests with qualifier code 06 when no specific variation is requested |
| Binary Counter Change Event Object | 32-bit -Time 32-bit +Time 16-bit -Time 16-bit +Time | 32-bit +Time | The default BC change event object variation for requests with qualifier code 06 when no specific variation is requested |
| Frozen Binary Counter Object | 32-bit +Flag 32-bit -Flag 32-bit +Time 16-bit +Flag 16-bit -Flag 16-bit +Time | 32-bit -Flag | The default frozen BC object variation for requests with qualifier code 06 when no specific variation is requested |
| DNP General Options | | | |
| 16-bit AI Scaling | Disabled Enabled | Enabled | Allows scaling 16-bit analog input objects (see description below) |
| 16-bit BC Scaling | x1, x10, x100, x1000 | x1 | Allows scaling 16-bit binary counter objects (see description below) |
| Re-mapping Event Points | Disabled Enabled | Disabled | Allows re-mapping event points starting with point 0. |
| SBO Timeout ¹ | 2-30 sec | 10 | Defines the Select Before Operate (SBO) timeout when using the Control-Relay-Output-Block object |
| Time Sync Period ² | 0-86400 sec | 86400 | Defines the time interval between periodic time synchronization requests |
| Multi Fragment Interval | 5-500 ms | 50 | Defines the time interval between segments of the response message when it is fragmented |

¹ The Select Before Operate command causes the device to start a timer. The following Operate command must be sent before the specified timeout value expires.

² The device requests time synchronization by bit 4 in the first octet of the internal indication word being set to 1 when the time interval specified by the Time Sync Period elapses. The master should synchronize the time in the device by sending the Time and Date object to clear this bit. The device does not send time synchronization requests if the Time Sync Period is set to 0.

³ The total number of AI, BI and BC change event points may not exceed 64. **When you change the number of the change event points in the device, all event setpoints are set to defaults** (see Configuring DNP Event Classes below).

Scaling 16-bit AI objects

Scaling 16-bit AI objects allows accommodating native 32-bit analog input readings to 16-bit object format; otherwise it may cause an over-range error if the full-range value exceeds a 16-bit point limit.

Scaling is enabled by default. It is not applied to points that are read using 32-bit AI objects.

Refer to the PM172 DNP3 Reference Guide for information on the data point scales and on a reverse conversion that should be applied to the received scaled values.

Scaling 16-bit Binary Counters

Scaling 16-bit Binary Counters allows changing a counter unit in powers of 10 to accommodate a 32-bit counter value to 16-bit BC object format.

If the scaling unit is greater than 1, the counter value is reported being divided by the selected scaling unit from 10 to 1000. To get the actual value, multiply the counter reading by the scaling unit.

Configuring DNP Class 0

The most common method of getting static object information from the meter via DNP is to issue a read Class 0 request.

The PM172 allows you to configure the Class 0 response by assigning ranges of points to be polled via Class 0 requests.

To view or change the factory-set DNP Class 0 assignments, select Protocol Setup from the Meter Setup menu and click on the DNP Class 0 Points tab.

The factory-set Class 0 point ranges are shown in the picture below. To change the factory settings and build your own Class 0 response message:

1. Select the object and variation type for a point range.
2. Specify the start point index and the number of points in the range. Refer to the PM172 DNP3 Reference Guide for available data points.
3. Repeat these steps for all point ranges you want to be included into the Class 0 response.
4. Click Send to download your setup to the meter.

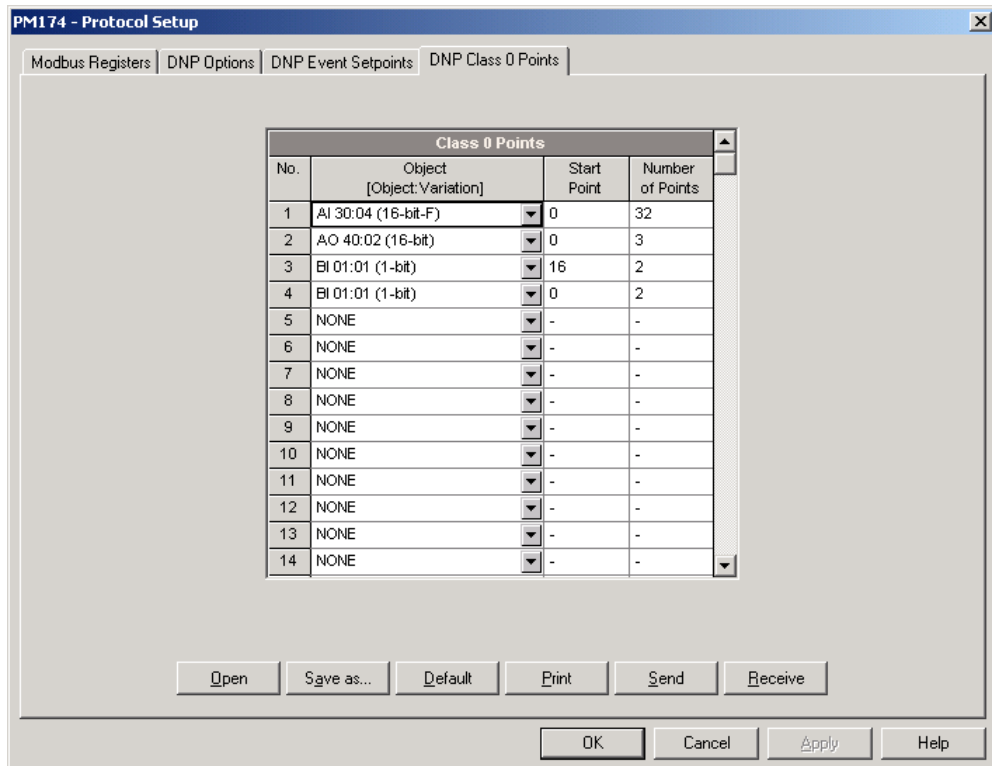

Configuring DNP Event Classes

The PM172 can generate object change events for any static analog input, binary input and binary counter point when a corresponding point either exceeds a predefined threshold, or the point status changes. A total of 64 change event points are available for monitoring.

Object change events are normally polled via DNP Class 1, Class 2 or Class 3 requests. You can link any change event point to any event class upon the event priority. Refer to the PM172 DNP3 Reference Guide for more information on polling event classes via DNP.

A change event point index is normally the same as for the corresponding static object point. If you wish to use independent numeration for event

points, enable re-mapping event point indices via DNP Options setup (see above) so they would start with index 0.

You should define a separate event setpoint for each static object point you wish to be monitored for change events. To view or change the factory-set DNP event setpoints, select Protocol Setup from the Meter Setup menu and click on the DNP Event Setpoints tab.

| No. | Event Point | Static Point | Ext | Group | Parameter | Relation | Threshold/Deadband | Ev On | Log On | Ev Class |
|-----|-------------|--------------|-------------------------------------|--------------|-----------|----------|--------------------|-------------------------------------|--------------------------|----------|
| 1 | AI:0 | AI:0 | <input type="checkbox"/> | AVR PHASE | V1 | < | 14000 | <input checked="" type="checkbox"/> | <input type="checkbox"/> | #1 |
| 2 | AI:1 | AI:1 | <input type="checkbox"/> | AVR PHASE | V2 | < | 14000 | <input checked="" type="checkbox"/> | <input type="checkbox"/> | #1 |
| 3 | AI:2 | AI:2 | <input type="checkbox"/> | AVR PHASE | V3 | < | 14000 | <input checked="" type="checkbox"/> | <input type="checkbox"/> | #1 |
| 4 | AI:3 | AI:3 | <input type="checkbox"/> | AVR PHASE | I1 | > | 500.00 | <input checked="" type="checkbox"/> | <input type="checkbox"/> | #1 |
| 5 | AI:4 | AI:4 | <input type="checkbox"/> | AVR PHASE | I2 | > | 500.00 | <input checked="" type="checkbox"/> | <input type="checkbox"/> | #1 |
| 6 | AI:5 | AI:5 | <input type="checkbox"/> | AVR PHASE | I3 | > | 500.00 | <input type="checkbox"/> | <input type="checkbox"/> | #1 |
| 7 | AI:22 | AI:22 | <input type="checkbox"/> | AVR AUX | In | > | 45.00 | <input checked="" type="checkbox"/> | <input type="checkbox"/> | #1 |
| 8 | AI:23 | AI:23 | <input type="checkbox"/> | AVR AUX | FREQ | Delta | 0.10 | <input checked="" type="checkbox"/> | <input type="checkbox"/> | #1 |
| 9 | AI:34 | AI:34 | <input type="checkbox"/> | AVR PHASE | V1 THD | > | 8.0 | <input checked="" type="checkbox"/> | <input type="checkbox"/> | #1 |
| 10 | AI:35 | AI:35 | <input type="checkbox"/> | AVR PHASE | V2 THD | > | 8.0 | <input checked="" type="checkbox"/> | <input type="checkbox"/> | #1 |
| 11 | AI:36 | AI:36 | <input type="checkbox"/> | AVR PHASE | V3 THD | > | 8.0 | <input checked="" type="checkbox"/> | <input type="checkbox"/> | #1 |
| 12 | AI:47872 | AI:47872 | <input checked="" type="checkbox"/> | ANALOG INPS | AI1 | > | 450 | <input checked="" type="checkbox"/> | <input type="checkbox"/> | #1 |
| 13 | BI:16 | BI:16 | <input type="checkbox"/> | DIGITAL INPS | DI1 | Delta | 0 | <input checked="" type="checkbox"/> | <input type="checkbox"/> | #2 |
| 14 | BI:17 | BI:17 | <input type="checkbox"/> | DIGITAL INPS | DI2 | Delta | 0 | <input checked="" type="checkbox"/> | <input type="checkbox"/> | #2 |
| 15 | BI:0 | BI:0 | <input type="checkbox"/> | RELAYS | RO1 | Delta | 0 | <input checked="" type="checkbox"/> | <input type="checkbox"/> | #2 |

The number of event setpoints for each static object type is specified via the DNP Options setup (see above). **Notice that the device clears all event buffers and links the default set of static points to each event object type every time you change the number of points for any of the objects.**

To define setpoints for selected static points:

1. Check the "Ext" box if you wish to use the extended point list.
2. Select a parameter group and then a desired parameter for each event point.
3. For AI and BC points, select a relation and an operating threshold or a deadband to be used for detecting events. All thresholds are specified in primary units. The following relations are available:

Delta - a new event is generated when the absolute value of the difference between the last reported point value and its current value exceeds the specified deadband value;

More than (over) - a new event is generated when the point value rises over the specified threshold, and then when it returns below the threshold minus a predefined return hysteresis - applicable for AI objects;

Less than (under) - a new event is generated when the point value drops below the specified threshold, and then when it returns above the threshold plus a predefined return hysteresis - applicable for AI objects.

A hysteresis for the return threshold is 0.05 Hz for frequency and 2% of the operating threshold for all other points.

4. Check the "Ev On" box for the points you wish to be included into event poll reports.
5. In the "Ev Class" box, select the event poll class for the change event points.
6. Repeat these steps for all points you want to be monitored for events.

Click Send to download your setup to the meter.

Remote Device Control

This section describes online operations on the meter you can perform through PAS. To access device control options you should have your device online.

Remote Relay Control

PAS allows you to send a command to any relay in your device or release a latched relay, except of the relays that are linked to an internal pulse source. These relays cannot be operated outside of the device.

To enter the Remote Relay Control dialog, check the On-line button on the PAS toolbar, select Device Control from the Monitor menu, and then click on the Remote Relay Control tab.

To send a remote command to the relay:

- From the "Relay Command" box for the relay, select the desired command:
 OPERATE - to operate a relay
 RELEASE - to remove your remote command, or to release a latched relay
- Click on Send.

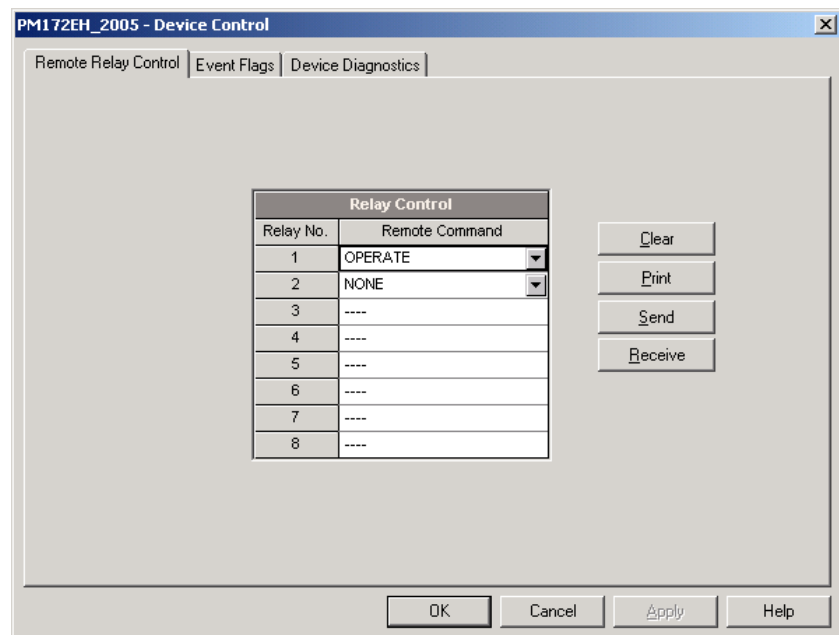

Event Flags

The PM172EH provides 8 common event flags that are intended for use as temporary event storage and can be tested and operated from the control setpoints. You can transfer an event to the setpoint and trigger its operation remotely by changing the event status through PAS.

To enter the Event Flags dialog, check the On-line button on the PAS toolbar, select Device Control from the Monitor menu, and then click on the Event Flags tab.

To change the status of an event flag:

- From the "Status" box, select the desired flag status.

2. Click on Send.

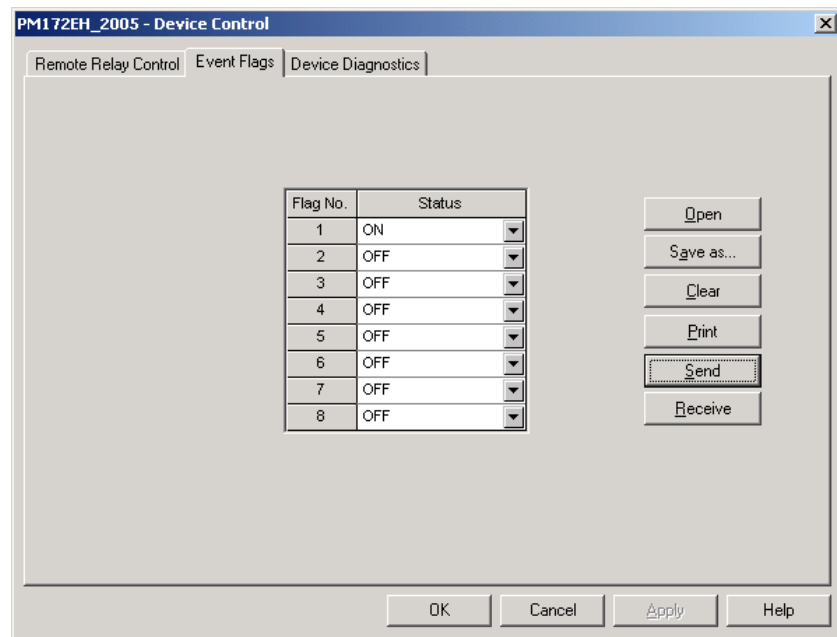

Device Diagnostics

Device diagnostic messages may appear as a result of the PM172 built-in diagnostic tests performed during a start-up and device operation.

To enter the Device Diagnostics dialog, check the On-line button on the PAS toolbar, select Device Control from the Monitor menu, and then click on the Device Diagnostics tab.

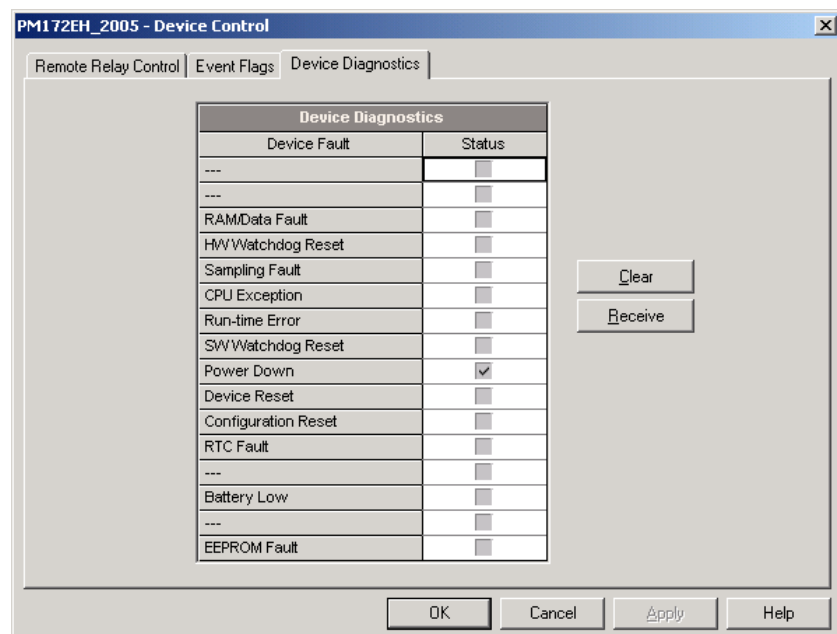

All diagnostic events are recorded to the Event log and can be inspected via PAS (see [Viewing the Device Event Log](#)). The diagnostics status is also recorded to a non-volatile register, which is not affected by loss of power and may be read and cleared via communications or via PAS.

Refer to PM172 communication guides for the diagnostic register address and layout. See [Device Diagnostic Codes](#) in Appendix F for the list of diagnostic codes and their meanings.

Frequent hardware failures may be the result of excessive electrical noise in the region of the device. If the meter continuously resets itself, contact your local distributor.

A configuration reset may also be a result of the legal changes in the meter configuration whenever other configuration data could be affected by the changes.

To clear the device diagnostics status, click on Clear.

Updating the Clock

To update the Real-Time Clock (RTC) in your device, check the On-line button on the PAS toolbar, and then select RTC from the Monitor menu or click on the Real-Time Clock button on the PAS toolbar.

The RTC dialog box displays the current PC time and the time in your device. To synchronize the device clock with the PC clock, click Set.

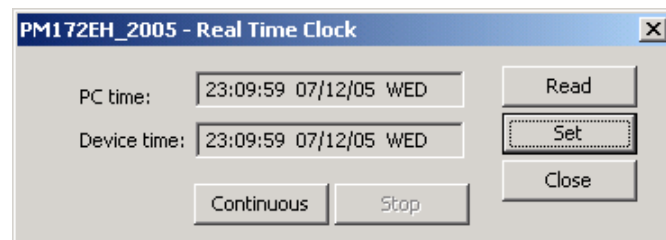

Resetting Accumulators and Clearing Log Files

PAS allows you to remotely clear energy accumulators, maximum demands, Min/Max log registers, counters and log files in your device. To open the dialog, check the On-line button, and then select Reset from the Monitor menu.

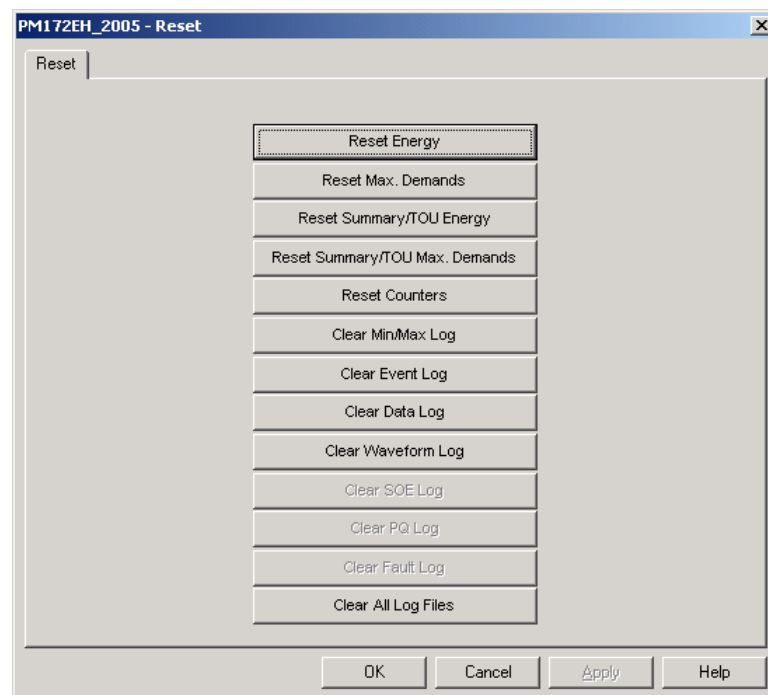

To reset the desired accumulation registers or to clear a file:

1. Click on the corresponding button, and then confirm your command.
2. If a target has more than one component, you are allowed to select components to reset.

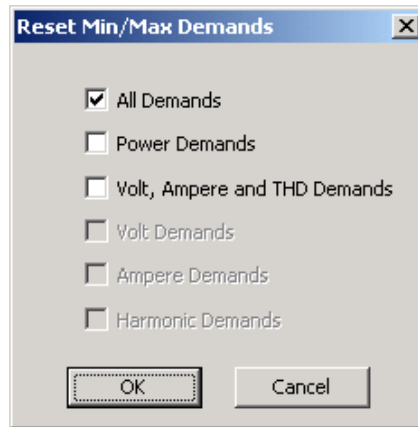

3. Check the corresponding boxes, and then click OK.

Administration

Changing a Password

PAS allows you to remotely change the password, and enable or disable the password security check in your meter. To change the password, check the On-line button, select Administration from the Monitor menu, and then select Change Password.

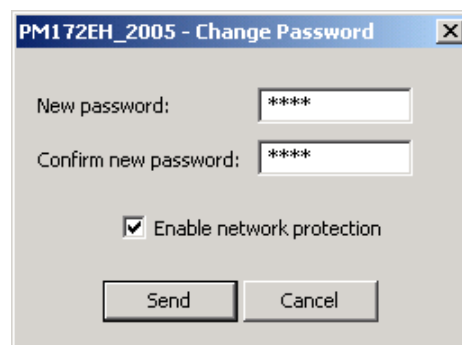

To change the password:

1. Type in a new 4-digit password
2. Repeat the password in the Confirm box
3. Check the "Enable network protection" to enable password checking
4. Click Send.

Upgrading Device Firmware

Your meter has upgradeable firmware. If you need to upgrade your device, download a new firmware file to the meter through PAS.

Firmware is downloaded through any communication port except the Profibus port. The meter may be connected to your PC through a serial interface, a dial-up modem or the Internet.

Upgrading firmware is only supported through the Modbus RTU and Modbus/TCP protocols, so your serial port or modem port should be put into Modbus RTU mode. If you are upgrading firmware through the Ethernet port and your device has a firmware build lower than 7, the device Ethernet port should also be configured to operate through the Modbus/TCP port 502.

To download a new firmware file to your device:

1. Ensure that the communication port you are connected through to the meter operates in Modbus RTU mode.
2. If the port is configured for a different protocol, put it into Modbus RTU mode either from the front display, or remotely through PAS. If you are connected to the meter through a serial interface, it is recommended to set the port baud rate to 115,200 bps. See “Configuring Communications in your Meter” on how to remotely change the protocol and baud rate in your meter.
3. Check the On-line button on the PAS toolbar, select Flash Downloader from the Monitor menu, and then confirm changes.

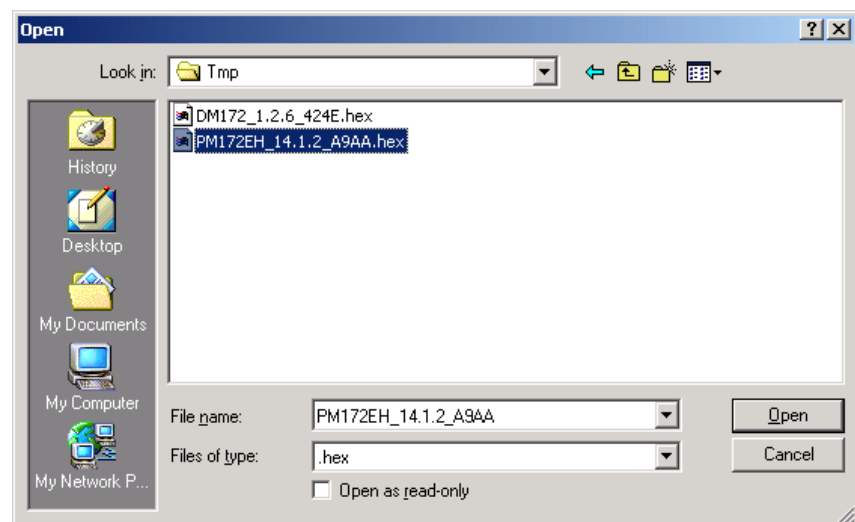

4. Point to the firmware upgrade file for your meter, click Open, and then confirm upgrading the meter. You are asked for the password regardless of the password protection setting in your meter.

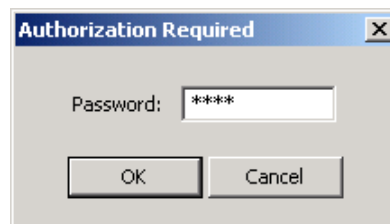

5. Type the meter password, and click OK. If you did not change the password in the meter, enter the default password 0.

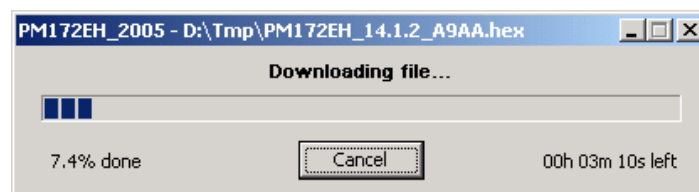

6. Wait until PAS completes upgrading your device. It takes about 3-4 minutes at 115,200 bps to download the file to the meter.



7. After upgrading firmware is completed, the meter restarts, so if it is connected through the modem to your PC, communications can be temporarily lost. You may need to a short duration until PAS restores a connection with your device.
8. You possibly need to restore the previous port settings in your meter if you changed them.

Monitoring Devices

Viewing Real-time Data

Real-time data is continuously retrieved from your devices, updated on the screen at the rate you defined in the Instrument Setup, and can be recorded to a file. You can view acquired data in a tabular or in a graphical form as a data trend.

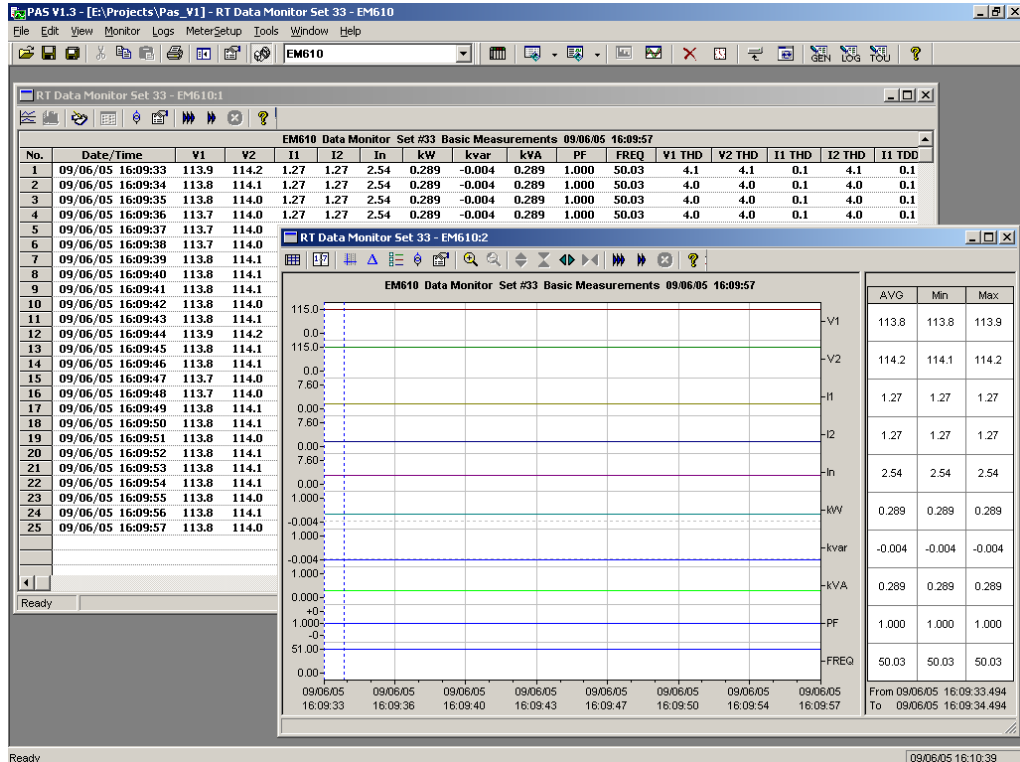

For information on the real-time data monitoring and recording options, see the "PAS Getting Started Guide".

Any data, energy and maximum demand registers in your meters can be read and recorded to files through the PAS Data Monitor. See Appendix D for a list of data available in your meter.

Viewing Min/Max Log



To retrieve the real-time Min/Max log data from your device, select the device site from the list box on the toolbar, select RT Min/Max Log from the Monitor menu, and then select a data set you want to view.

For more information on the Min/Max data monitoring options, see the "PAS Getting Started Guide".

Viewing Real-time Waveforms

The PM172EH allows you to retrieve the real-time waveforms from your meter.



To retrieve the real-time waveforms, select the device site from the list box on the PAS toolbar, and then select RT Waveform Monitor from the Monitor menu or click on the  button on the PAS toolbar.

Use the blue arrowhead buttons  and  for one-time or continuous waveform polling. Use the Stop button  to stop continuous polling.

See [Viewing Waveforms](#) for information on using waveform views.

Viewing Harmonic Spectrum and Synthesized Waveforms

To retrieve the real-time harmonic spectrum, select the device site from the list box on the PAS toolbar, and then select RT Harmonic Monitor from the Monitor menu or click on the  button on the PAS toolbar. Harmonics can be displayed as a spectrum chart or in a table.

PAS can also synthesize waveforms based on the harmonic spectrum to let you view a waveshape of the voltage and current waveforms. Use the  and  buttons on the local toolbar to view the synthesized waveforms in an overlapped or non-overlapped view.

See [Viewing Waveforms](#) for more information on using different spectrum and waveform views.

Viewing Recorded Files

Retrieving Logs Files

Using PAS, you can retrieve recorded events, data and waveforms from your PM172E and PM172EH meters and save them to files on your PC in the MS Access database format.

Historical data can be uploaded on demand any time you need it, or periodically through the Upload Scheduler that can retrieve data automatically on a predefined schedule, for example, daily, weekly or monthly. If you do not change the destination database location, new data will be added to the same database so you can have long-term data profiles in one database regardless of the upload schedule you selected.

For information on uploading files and configuring the Upload Scheduler for your meters, see the “PAS Getting Started Guide”.

Viewing Options

Uploaded data can be viewed on the screen, printed, and exported to other applications.

To open a log file, click on the Open button on the PAS toolbar or select “Open...” from the File menu, select “Access Database (*.mdb)” in the “Files of type” box, point to the log file, select a desired table on the right pane, and then click Open.

PAS offers you different options for easy analysis of retrieved trend and fault data. Data can be displayed in primary or secondary units. You can use filtering to find out and work with a subset of events that meet the criteria you specify, or use sorting to rearrange records in the desired order. PAS can also link events and the corresponding data records and waveforms together to allow you more effective analysis of recorded events.

See the “PAS Getting Started Guide” for more information on viewing log files and available options.

Viewing the Device Event Log

Event log files are displayed in a tabular view. PAS loads the entire database table to a window, so that you can scroll through the entire log to view its contents.

| No. | Date/Time | Event | Cause | Point/Source | Trigg. Value | Effect | Target |
|-----|-----------------------|-------|----------------|-----------------------|--------------|---------------|--------|
| 121 | 30/09/99 10:19:41.000 | SP4 | SP EVENT | V2 | 23299 | SP. RELEASED | #4 |
| 122 | 30/09/99 10:19:41.000 | SP4 | SP EVENT | V3 | 23287 | SP. RELEASED | #4 |
| 123 | 30/09/99 10:19:41.000 | SP5 | SP EVENT | V HIGH | 23326 | SP. RELEASED | #5 |
| 124 | 30/09/99 10:19:41.000 | SP5 | SP EVENT | V LOW | 23287 | SP. RELEASED | #5 |
| 125 | 30/09/99 10:19:46.000 | SP10 | SP EVENT | kW | 9682 | SP. RELEASED | #10 |
| 126 | 30/09/99 10:30:54.000 | | EXTERNAL | POWER DOWN | | | |
| 127 | 30/09/99 10:30:55.000 | | EXTERNAL | POWER UP | | | |
| 128 | 30/09/99 10:30:55.000 | SP1 | SP EVENT | V UNB% | 0 | SP. RELEASED | #1 |
| 129 | 30/09/99 10:30:55.000 | SP1 | SP EVENT | FREQ | 49.9 | SP. RELEASED | #1 |
| 130 | 30/09/99 10:30:55.000 | SP1 | SP EVENT | FREQ | 49.9 | SP. RELEASED | #1 |
| 131 | 30/09/99 10:30:55.000 | SP2 | SP EVENT | V1 | 23354 | SP. RELEASED | #2 |
| 132 | 30/09/99 10:30:55.000 | SP2 | SP EVENT | V2 | 23293 | SP. RELEASED | #2 |
| 133 | 30/09/99 10:30:55.000 | SP2 | SP EVENT | V3 | 23282 | SP. RELEASED | #2 |
| 134 | 01/10/99 00:00:00.000 | SP8 | SP ACTION | SETPOINT #8 | | CLR EVNT FLAG | #1 |
| 135 | 01/10/99 07:23:00.000 | SP1 | SP EVENT | V UNB% | 0 | SP. RELEASED | #1 |
| 136 | 02/10/99 08:34:21.000 | SP1 | SP EVENT | V UNB% | 0 | SP. RELEASED | #1 |
| 137 | 02/10/99 08:34:21.000 | SP1 | SP EVENT | FREQ | 50.1 | SP. RELEASED | #1 |
| 138 | 02/10/99 08:34:21.000 | SP1 | SP EVENT | FREQ | 50.1 | SP. RELEASED | #1 |
| 139 | 07/10/99 07:10:25.000 | SP1 | SP EVENT | FREQ | 49.9 | SP. RELEASED | #1 |
| 140 | 07/10/99 07:10:25.000 | SP1 | SP EVENT | FREQ | 49.9 | SP. RELEASED | #1 |
| 141 | 07/10/99 16:39:16.000 | SP10 | SP EVENT | kW | 11012 | SP. OPERATED | #10 |
| 142 | 07/10/99 16:39:16.000 | SP10 | SP ACTION | SETPOINT #10 | | OPER. RELAY | #1 |
| 143 | 07/10/99 20:50:55.000 | SP1 | SP EVENT | V UNB% | 15 | SP. OPERATED | #1 |
| 144 | 07/10/99 20:50:55.000 | SP1 | SP EVENT | V UNB% | 0 | SP. RELEASED | #1 |
| 145 | 07/10/99 20:50:55.000 | SP1 | SP EVENT | FREQ | 49.9 | SP. RELEASED | #1 |
| 146 | 07/10/99 20:50:55.000 | SP1 | SP EVENT | FREQ | 49.9 | SP. RELEASED | #1 |
| 147 | 07/10/99 20:57:49.000 | SP10 | SP EVENT | kW | 9992 | SP. RELEASED | #10 |
| 148 | 08/10/99 09:13:26.000 | SP1 | SP EVENT | V UNB% | 0 | SP. RELEASED | #1 |
| 149 | 08/10/99 09:13:26.000 | | Waveform Log 1 | 08/10/99 09:13:25.960 | 50.0 | SP. RELEASED | #1 |
| 150 | 08/10/99 09:13:26.000 | SP1 | SP EVENT | FREQ | 50.0 | SP. RELEASED | #1 |
| 151 | 08/10/99 21:02:24.000 | SP1 | SP EVENT | V UNB% | 17 | SP. OPERATED | #1 |
| 152 | 08/10/99 21:02:25.000 | SP1 | SP EVENT | V UNB% | 0 | SP. RELEASED | #1 |
| 153 | 08/10/99 21:02:25.000 | SP1 | SP EVENT | FREQ | 50.0 | SP. RELEASED | #1 |
| 154 | 08/10/99 21:02:25.000 | SP1 | SP EVENT | FREQ | 50.0 | SP. RELEASED | #1 |
| 155 | 09/10/99 14:40:10.000 | SP1 | SP EVENT | FREQ | 49.5 | SP. OPERATED | #1 |
| 156 | 09/10/99 14:40:12.000 | SP1 | SP EVENT | V UNB% | 0 | SP. RELEASED | #1 |
| 157 | 09/10/99 14:40:12.000 | SP1 | SP EVENT | FREQ | 50.0 | SP. RELEASED | #1 |

Filtering and Sorting Events

To filter events, click on the Filter button , or click on the report window with the right mouse button and select "Filter...". Check the causes of events you want to display, and then click OK.

Event records are normally shown in the order based on the date and time of the event appearance. To change the sorting order, click on the Sort button , or click on the report window with the right mouse button and select "Sort...", check the desired sort order, and then click OK.

Linking to Waveforms and Data Records

If a setpoint triggers the Waveform or Data recorder and is programmed to log setpoint events to the Event log (see [Recording Setpoint Events](#)), then PAS automatically establishes links to retrieved waveforms and data records where it finds a relationship with the event.

The event ID for which PAS finds related data is blue colored. To check a list of the event links, click on the colored event ID. Click on a list item to move to the waveform or data log record.

Selecting Primary and Secondary Units



Voltages and currents can be displayed in primary or secondary units. Click on the report window with the right mouse button, select Options, select the desired units for voltages and currents, and then click OK.

Viewing the Data Log

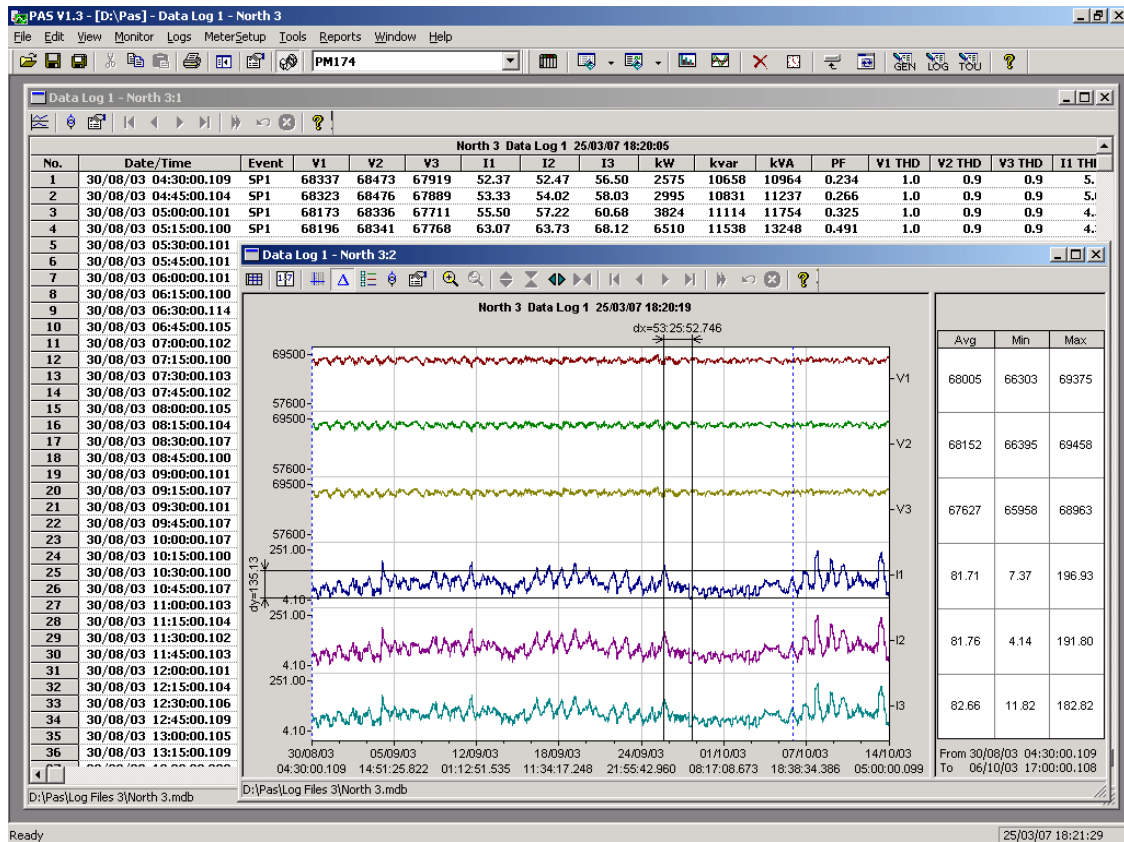
Data log files can be displayed in a tabular view or in a graphical view as a data trend graph.



Viewing Data Trend

To view data in a graphical form, click on the Data Trend  button on the local toolbar. To change the time range for your graph, click on the Time Range button , and then select the desired date and time range.



To select desired data channels for your trend, click on the trend window with the right mouse button, select "Channels", check the channels you want displayed, and then click OK.

See [Viewing Waveforms](#) for information on customizing the trend view and on the available graphics options.

Viewing Waveforms

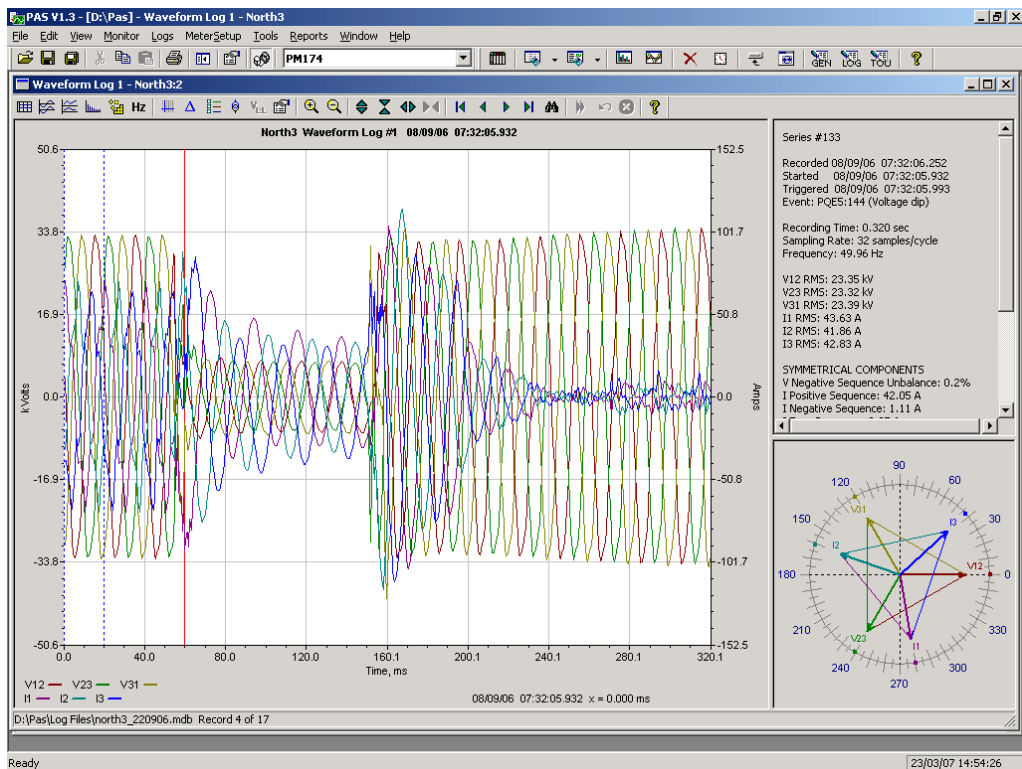
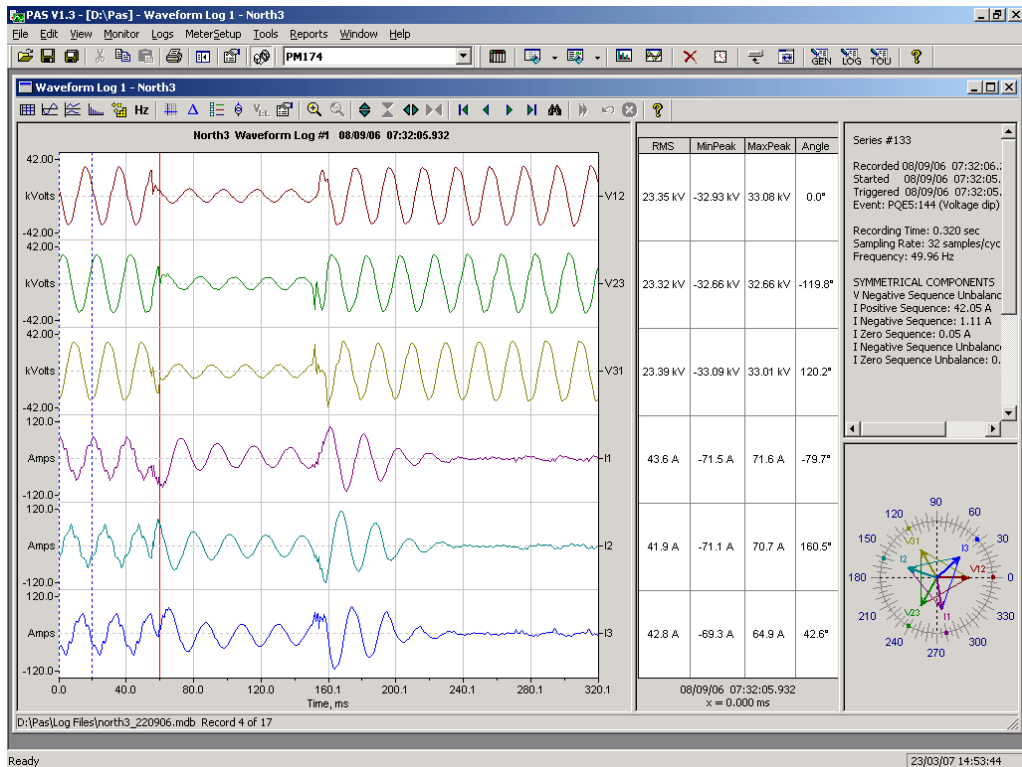
When you open a new file, PAS shows you a waveform graph with non-overlapped waveforms. Each waveform window has a local toolbar from where you can open another window to examine the waveform in a different view. When you move to another waveform record, all waveform views are updated simultaneously to reflect the changes.



Click on the  button on the local toolbar to view overlapped waveforms, and click on the  button to view non-overlapped waveforms.

Waveform data is recorded in series that may contain many cycles of the sampled waveform. A waveform window displays up to 128 waveform cycles. If the waveform contains more cycles, the scroll bar appears under the waveform pane allowing you to scroll through the entire waveform.

Selecting Waveform Channels

To select the channels you want to view on the screen, click on the waveform window with the right mouse button, select “Channels...”, check the channels you want displayed, and then click OK.

Using the Marker Lines

Waveform and RMS panes have two blue dashed marker lines. The left marker indicates the position from where data is taken to calculate the harmonics spectrum and phasor diagrams, and as the starting position for calculating the RMS, average and peak values. The right marker indicates the end position for calculating the RMS, average and peak values. The minimum distance between the two markers is exactly one cycle.

To change the marker position, click on the  button, or click on the waveform window with the right mouse button and select Set Marker, and then click on the point where you want to put the marker. You can drag both markers with the mouse, or use the right and left arrow keys on your keyboard to change the marker position. Click on the waveform pane to allow the keyboard to get your input before using the keyboard.

Delta Measurements

To measure the distance between two waveform points, click on the Delta button , then click on one point, and then click on the second point. The first reference point is still frozen until you close and reopen Delta, while the second point can be placed anywhere within the waveform line. You can measure a delta in both directions. To disable the Delta, click on the Delta button once again.

Selecting the Time Axis

The horizontal axis can be displayed either in absolute time with date and time stamps, or in milliseconds relatively to the beginning of a waveform. To change the time units, click on the waveform window with the right mouse button, select “Options...”, click on the “Axes” tab, select the desired units, and then click OK.

Viewing Phasor Diagrams

The phasor diagrams show you the relative magnitudes and angles of the three-phase voltage and current fundamental component. All angles are shown relative to the reference voltage channel.

To change the reference channel, click on the waveform window with the right mouse button, select “Options...”, click on the “Phasor” tab, check the channel you want to make a reference channel, and then click “OK”.

If you leave the Triangle box checked, PAS connects the ends of the voltage and current vectors showing you three-phase voltage and current triangles. This is useful when analyzing voltage and current unbalances.

Phasor diagrams are calculated over one waveform cycle pointed to by the left marker line. As you move the marker, the phasor diagrams are updated reflecting the new marker position.

Viewing Symmetrical Components

PAS can calculate the symmetrical components for voltages and currents at the point indicated by the left marker line. To enable or disable the symmetrical components, click on the waveform window with the right mouse button, select “Options...”, check or uncheck the “Symmetrical components” box on the “Channels” tab, and then click OK.

Selecting Primary and Secondary Units

Voltages and currents can be displayed in primary or secondary units. Click on the waveform window with the right mouse button, select “Options...”,

select the desired units for voltages and currents on the Channels tab, and then click OK.

Using a Zoom

Use the green arrowheads on the local toolbar to zoom in or out of the waveform graph. Every click on these buttons gives you a 100-percent horizontal or 50-percent vertical zoom. Use the magnifying glass buttons to get a proportional zoom in both directions.

When in the overlapped waveform view, you can zoom in on a selected waveform region. Click on the waveform window with the right mouse button, click 'Zoom', point onto one of the corners of the region you want to zoom in, press and hold the left mouse button, then point to another corner of the selected region and release the mouse button.

Customizing Line Colors and Styles

To change the colors or line styles, click on the waveform window with the right mouse button, select "Options...", click on the Display tab, adjust colors and styles, and then click OK. You can also change the waveform background and gridlines color.

Viewing an RMS Plot

Click on the  button to open the RMS view. PAS shows you a cycle-by-cycle RMS plot of the sampled AC waveforms.

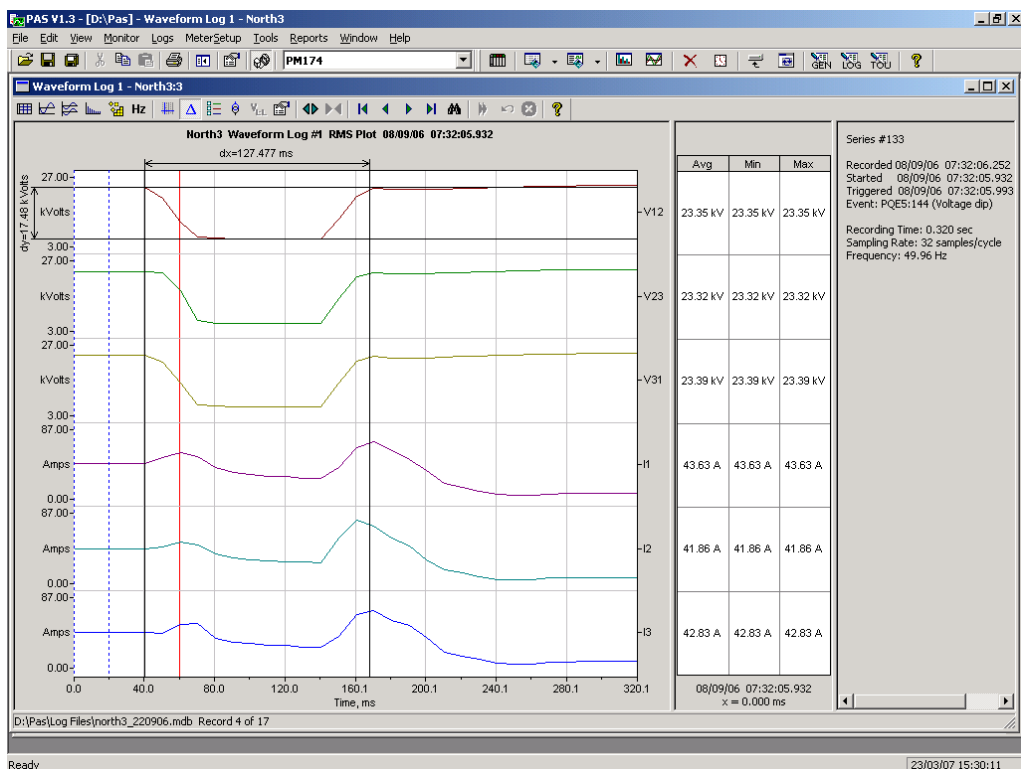

Viewing a Spectrum Chart

Click on the  button to view a spectrum chart. To change a channel, click on the window with the right mouse button, select "Channels...", check the channel you want displayed, and then click OK.

A spectrum is calculated over four cycles of the waveform beginning from the point where the left marker line is located. If there are more than one waveform views open, PAS gives the priority to the overlapped waveform view.

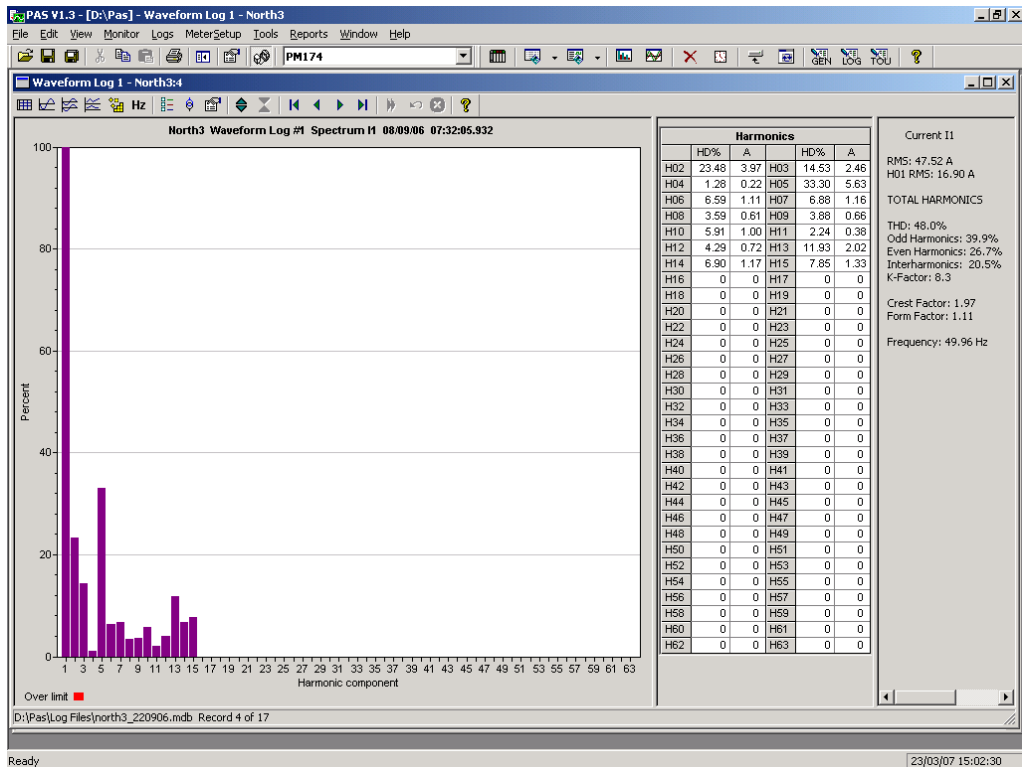

PAS can give you indication on whether harmonic levels in the sampled waveforms exceed compliance limits defined by the power quality standards or local regulations.

To review or change harmonic limits:

1. Click on the spectrum window with the right mouse button and select "Limits..."

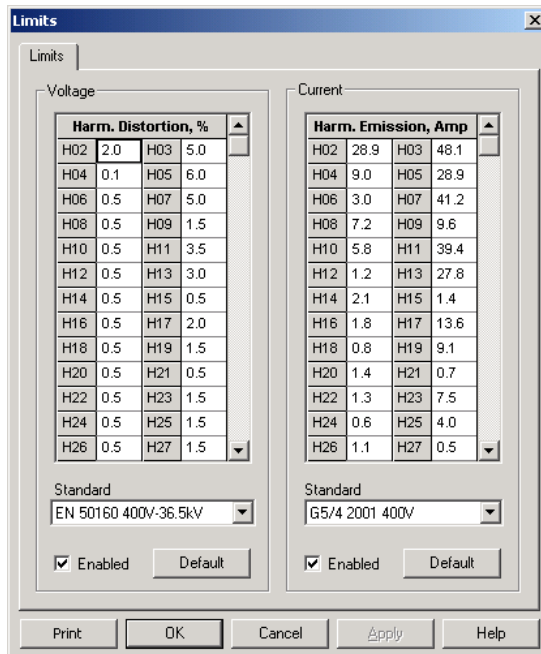

2. Select a harmonics standard, or select "Custom" and specify your own harmonic limits.
3. Check the Enabled box to visualize harmonic faults on the spectrum graph and in harmonic tables.

Harmonics that exceed selected compliance levels are colored in red on the graph and in the tables.

Viewing a Spectrum Table

Click on the  button on the local toolbar. The spectrum table displays voltage, current, active power and reactive power harmonic components both in percent of the fundamental and in natural units, and phase angles between the harmonic voltage and current.

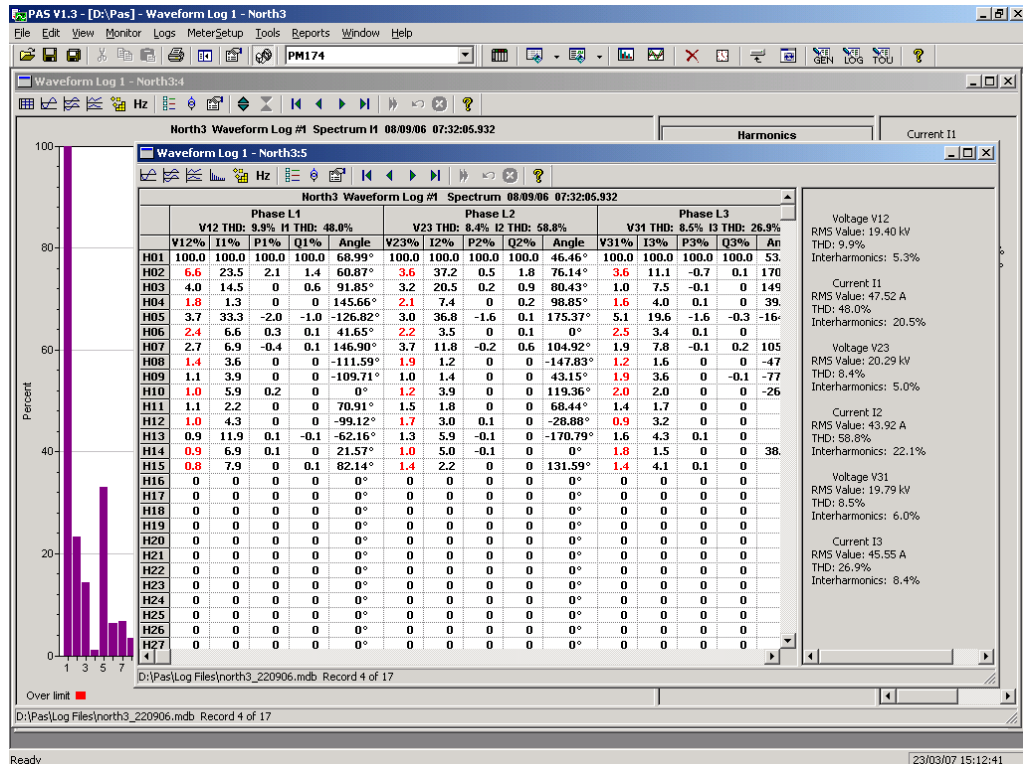

To change a phase, click on the window with the right mouse button, select "Options...", check the phase you want displayed, and then click OK.

Viewing a Frequency Plot

Click on the  button to view a cycle-by-cycle voltage frequency plot.

Viewing Synchronized Waveforms

If you have a number of devices with synchronized clocks, you can view waveforms recorded at different locations in one window. PAS synchronizes the time axes for different waveforms so they could be displayed in a single plot.

To get synchronized waveforms:

1. Put the databases with waveforms into the same folder, or put the sites from which you have uploaded data to the same group in the sites tree.
2. Open a waveform you want to synchronize with other waveforms, and then click on the Multi-site View button . PAS searches for time-coordinated waveforms that have the same time span as the selected waveform.

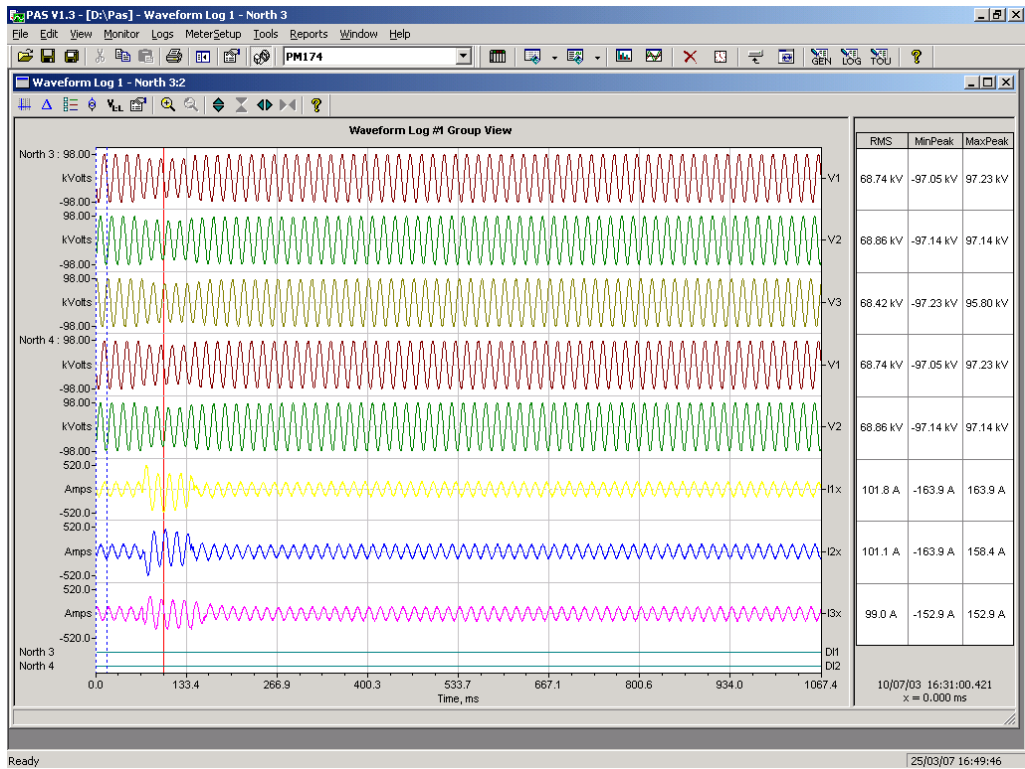

3. Check the sites you want to see displayed.

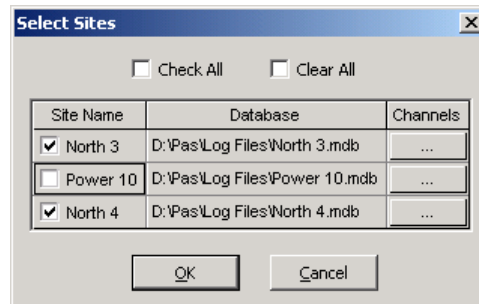

4. Click on the "Channels" button and select channels for each site.
5. Click OK.

To change the channels, click on the waveform window with the right mouse button and select "Channels...".

COMTRADE and PQDIF Converters

The COMTRADE and PQDIF file converters allow you to convert retrieved waveforms into COMTRADE or PQDIF file format, and data log tables - into PQDIF format.

Manual Converting

To manually convert your waveforms or a data log into COMTRADE or PQDIF format:

1. Click on the Export  button on the PAS toolbar.

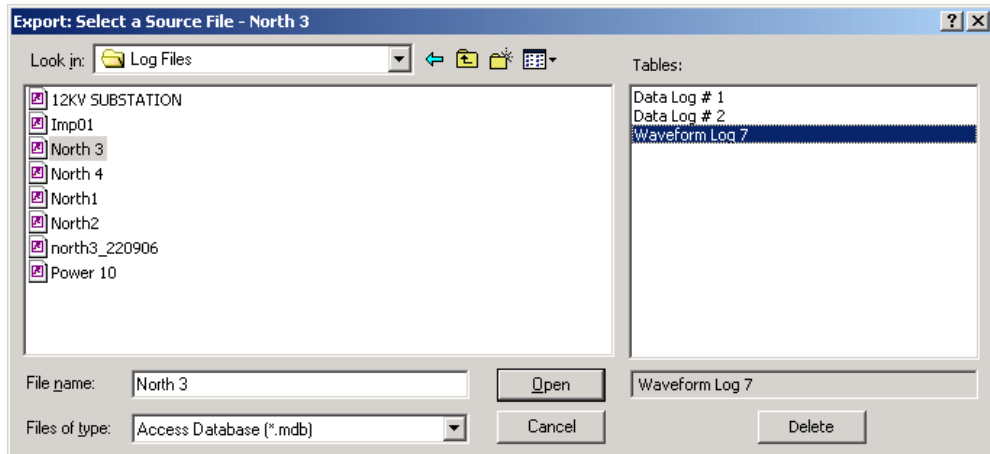

2. Select the database and a waveform or data log table you want to export, and then click Open.

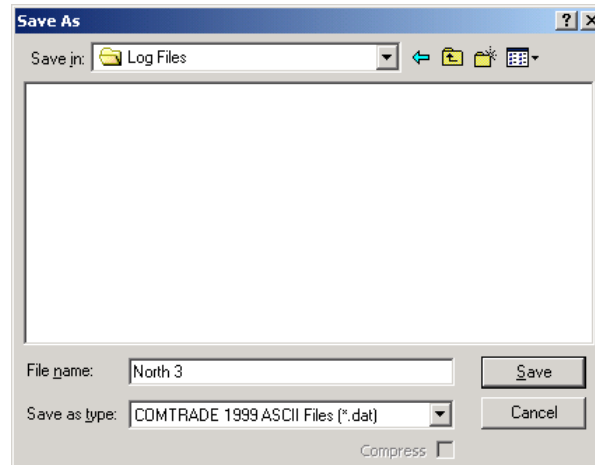

3. Select a directory where you want to store your exported files, type a file name that identifies your files, select a desired file output format, and then click on the Save button. The PQDIF files are commonly recorded in compressed format. If you do not want your files to be compressed, uncheck the Compress box before saving the file.

In COMTRADE format, each waveform event is recorded into a separate file. A COMTRADE waveform file name contains a site name followed by an ID of the fault or power quality event, which triggered the waveform record.

PQDIF file names contain a site name followed by a timestamp of the first event recorded to the file, and may look like 12KVSUB_20040928T133038.pqd.

Automatic Converting

PAS allows you to automatically convert waveform and data logs into COMTRADE or PQDIF format at the time you upload data from your devices via the Upload Scheduler.

To automatically convert your waveform or data log tables into COMTRADE or PQDIF format:

1. Open the Upload Scheduler.

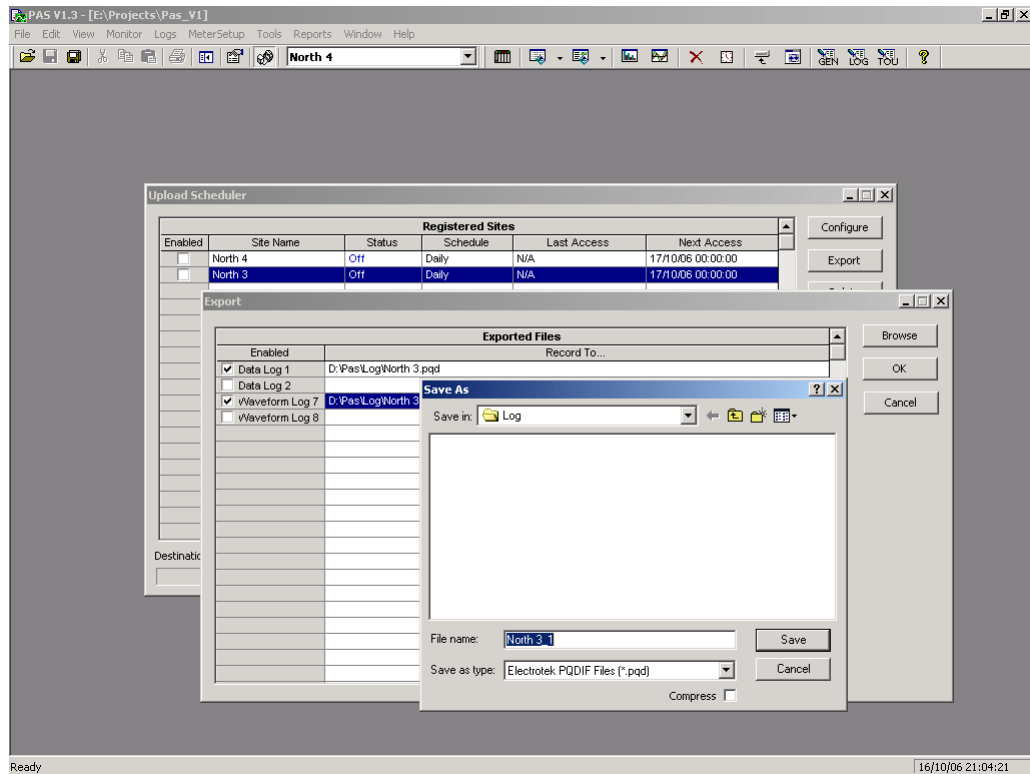

2. Highlight a desired device site with the left mouse button, and then click on the Export button.
3. Check the Enabled box for a data log or a waveform log table you want to automatically convert at the upload time.
4. Highlight the Record to... row for the selected table and click on the Browse button.
5. Select a folder where you want to store converted files, type in the converted file's name, select a desired output file format, and then click on Save.
6. Repeat the same for all tables you wish to be converted.
7. Click OK.

Appendix A Technical Specifications

Environmental Conditions

Operating temperature: -20°C to 60°C (-4°F to 140°F)

Storage temperature: -25°C to 80°C (-13°F to 176°F)

Humidity: 0 to 95% non-condensing

Construction

Dimensions see Figure 2-1

Weight: 1.23kg (2.7 lb.)

Materials

Case enclosure: plastic PC/ABS blend

Display body: plastic PC/ABS blend

Front panel: plastic PC

PCB.: FR4 (UL94-V0)

Terminals: PBT (UL94-V0)

Connectors-Plug-in type: Polyamide PA6.6 (UL94-V0)

Packaging case: Carton and Stratocell® (Polyethylene Foam) brackets

Labels: Polyester film (UL94-V0)

Power Supply

120/230 VAC-110/220 VDC Option:

Rated input 85-264VAC 50/60 Hz, 88-290VDC, Burden 10W

Isolation:

Input to output: 3000 VAC

Input to ground: 2000 VAC

12 VDC Option: Rated input 9.6-19 VDC

24 VDC Option: Rated input 19-37 VDC

48 VDC Option: Rated input 37- 72 VDC

Wire size: up to 12 AWG (up to 3.5 mm²)

Input Ratings

Voltage Inputs

Operating range: 690VAC line-to-line, 400VAC line-to-neutral

Direct input and input via PT (up to 828VAC line-to-line, up to 480VAC line-to-neutral)

Input impedance: 500 kOhm

Burden for 400V: < 0.4 VA

Burden for 120V: < 0.04 VA

Overvoltage withstand: 1000 VAC continuous, 2000 VAC for 1 second

Galvanic isolation: 3500 VAC

Wire size: up to 12 AWG (up to 3.5mm²)

Current Inputs

Wire size: 12 AWG (up to 3.5 mm²)

Galvanic isolation: 3500 VAC

5A secondary

Operating range: continuous 10A RMS Burden: < 0.1 VA

Overload withstand: 15A RMS continuous, 300A RMS for 1 second

1A secondary

Operating range: continuous 2A RMS Burden: < 0.02 VA

Overload withstand: 6A RMS continuous, 80A RMS for 1 second

Relay Outputs

2 relays rated at 3A/250 VAC; 3A/30 VDC, 2 contacts (SPST Form A)

Wire size: 14 AWG (up to 1.5 mm²)

Galvanic isolation:

Between contacts and coil: 2000 VAC 1 min

Between open contacts: 1000 VAC

Operate time: 10 ms max.

Release time: 5 ms max.

Update time: 1 cycle

Digital Inputs

2 Digital Inputs Dry Contacts

Sensitivity: Open @ input resistance >100 kOhm, Closed @ Input resistance < 100 Ohm

Wire size: 14 AWG (up to 1.5 mm²)

Galvanic isolation: 2000V RMS

Internal power supply 15V

Scan time: 1 ms

Optional Analog Inputs

2 Analog Inputs (optically isolated)

Ranges (upon order):

±1 mA (100% overload) - Input resistance 1.2 kOhm

0-20 mA - Input resistance 250 Ohm

4-20 mA - Input resistance 250 Ohm

0-1 mA (100% overload) - Input resistance 2.4 kOhm

Wire size: 14 AWG (up to 1.5 mm²)

Isolation: 2,000 V RMS

Accuracy: 0.5% FS

Scan time: 1 cycle

Optional Analog Outputs

2 Analog Outputs (optically isolated)

Ranges (upon order):

±1 mA, maximum load 5 kΩ (100% overload)

0-20 mA, maximum load 510 Ω

4-20 mA, maximum load 510 Ω

0-1 mA, maximum load 5 k Ω (100% overload)

Isolation: 2,000 V RMS

Power supply: internal

Accuracy: 0.5% FS

Wire size: 14 AWG (up to 1.5 mm²)

Update time: 1 cycle

Communication Ports

COM1 (Optional modules)

Serial EIA RS-232 optically isolated port

Isolation: 2,000 V RMS
Connector type: DB9 female.
Baud rate: up to 115.2 kbps.
Supported protocols: Modbus RTU, DNP3, and SATEC ASCII.

RS-422/RS-485 optically isolated port

Isolation: 2,000 V RMS
Connector type: DB9 female.
Baud rate: up to 115.2 kbps.
Supported protocols: Modbus RTU, DNP3, and SATEC ASCII.

Ethernet Port

Transformer-isolated 10/100BaseT Ethernet port.
Connector type: RJ45 modular.
Supported protocols: Modbus/TCP (Port 502), DNP3/TCP (Port 20000), GE EGD producer.
Number of simultaneous connections: 4 (4 Modbus/TCP or 2 Modbus/TCP + 2 DNP3/TCP).

Dial-up Modem

Transformer-isolated internal 56K modem.
Connector type: RJ11.
Supported protocols: Modbus RTU, DNP3, and SATEC ASCII.

Profibus DP (IEC 61158)

RS-485 optically isolated Profibus interface.
Connector Type: DB9 female.
Baud Rate: 9600 bit/s - 12 Mbit/s (auto detection).
32 bytes input, 32 bytes output.
Supported Protocols: PROFIBUS.

COM2

RS-422/RS-485 optically isolated port

Isolation: 2,000 V RMS
Connector type: removable, 5 pins.
Wire size: up to 14 AWG (up to 1.5 mm²).
Baud rate: up to 115.2 kbps.
Supported protocols: Modbus RTU, DNP3, and SATEC ASCII.

Real-time Clock

Accuracy: typical error 30 seconds per month @ 25°C

Log Memory

Onboard memory with battery backup: 1 Mbytes.

Display Module

Display: high-brightness seven-segment digital LEDs, two 4-digit + one 6-digit windows
Keypad: 6 push buttons

Communication: EIA RS-485 port with 12V supply voltage
Connector type: DB15, 15 pins
Wires size: up to 14 AWG (up to 1.5 mm²)
Distance: up to 1000 m (3200 feet)
Supply Voltage: 12VDC +/- 10%
Power consumption: 2W

Standards Compliance

Accuracy per ANSI C12.20 -1998

UL File no. E236895

Directive complied with:

EMC: 89/336/EEC as amended by 92/31/EEC and 93/68/EEC

LVD: 72/23/EEC as amended by 93/68/EEC and 93/465/EEC

Harmonized standards to which conformity is declared:

EN55011: 1991

EN50082-1: 1992

EN61010-1: 1993

A2/1995

EN50081-2 Generic Emission Standard - Industrial Environment

EN50082-2 Generic Immunity Standard - Industrial Environment

EN55022: 1994 Class A

EN61000-4-2

ENV50140: 1983

ENV50204: 1995 (900MHz)

ENV50141: 1993

EN61000-4-4:1995

EN61000-4-8: 1993

Measurement Specifications

| Parameter | Full Scale @ Input Range | Accuracy | | | Range |
|--|---------------------------------------|---|------|---|--|
| | | % Reading | % FS | Conditions | |
| Voltage | 120VxPT @ 120V 400VxPT @ 690V | 0.2 | 0.01 | 10% to 120% FS | 0 to 1,150,000 V Starting voltage 1.5% FS |
| Line current | CT | 0.2 | 0.02 | 1% to 200% FS | 0 to 40,000 A Starting current 0.1% FS |
| Active power | 0.36xPTxCT @ 120V 1.2xPTxCT @ 690V | 0.2 | 0.02 | $ PF \geq 0.5$ ¹ | -10,000,000 kW to +10,000,000 kW |
| Reactive power | 0.36xPTxCT @ 120V 1.2xPTxCT @ 690V | 0.3 | 0.04 | $ PF \leq 0.9$ ¹ | -10,000,000 kvar to +10,000,000 kvar |
| Apparent power | 0.36xPTxCT @ 120V 1.2xPTxCT @ 690V | 0.2 | 0.02 | $ PF \geq 0.5$ ¹ | 0 to 10,000,000 kVA |
| Power factor | 1.000 | | 0.2 | $ PF \geq 0.5$, $I \geq 2\%$ FSI | -0.999 to +1.000 |
| Frequency | | 0.02 | | | 15 Hz to 480 Hz |
| Total Harmonic Distortion, THD V (I), %V _f (%I _f) | 999.9 | 1.5 | 0.1 | THD $\geq 1\%$, V (I) $\geq 10\%$ FSV (FSI) | 0 to 999.9 |
| Total Demand Distortion, TDD, % | 100 | | 1.5 | TDD $\geq 1\%$, $I \geq 10\%$ FSI | 0 to 100 |
| Active energy Import & Export | | Class 0.2S under conditions as per IEC 62053-22:2003 | | | 0 to 999,999.999 MWh |
| Reactive energy Import & Export | | Class 0.2S under conditions as per IEC 62053-22:2003, $ PF \leq 0.9$ | | | 0 to 999,999.999 Mvarh |
| Apparent energy | | Class 0.2S under conditions as per IEC 62053-22:2003 | | | 0 to 999,999.999 MVAh |

¹ @ 80% to 120% of voltage FS, 1% to 200% of current FS, and frequency 50/60 Hz

PT - external potential transformer ratio

CT - primary current rating of external current transformer

FSV - voltage full scale

FSI - current full scale

V_f - fundamental voltage

I_f - fundamental current

NOTES

1. Accuracy is expressed as \pm (percentage of reading + percentage of full scale) ± 1 digit. This does not include inaccuracies introduced by the user's potential and current transformers. Accuracy calculated at 1second average.

2. Specifications assume: voltage and current waveforms with THD $\leq 5\%$ for kvar, kVA and PF, and reference operating temperature 20°C - 26°C.

3. Measurement error is typically less than the maximum error indicated.

Appendix B Analog Output Parameters

The following table lists parameters that can be provided on the meter's analog outputs and on the external analog expander outputs.

| Display Code | Designation | Description |
|--------------|------------------------|-------------------------------------|
| nonE | NONE | None (output disabled) |
| | | 1-Cycle Phase Values |
| rt.U1 | V1/12 RT ¹ | V1/V12 Voltage |
| rt.U2 | V2/23 RT ¹ | V2/V23 Voltage |
| rt.U3 | V3/31 RT ¹ | V3/V31 Voltage |
| rt.U12 | V12 RT | V12 Voltage |
| rt.U23 | V23 RT | V23 Voltage |
| rt.U31 | V31 RT | V31 Voltage |
| rt.C1 | I1 RT | I1 Current |
| rt.C2 | I2 RT | I2 Current |
| rt.C3 | I3 RT | I3 Current |
| | | 1-Cycle Total Values |
| rt.Ac.P | kW RT | Total kW |
| rt.rE.P | kvar RT | Total kvar |
| rt.AP.P | kVA RT | Total kVA |
| rt.PF | PF RT | Total PF |
| rt.PF.LG | PF LAG RT | Total PF Lag |
| rt.PF.Ld | PF LEAD RT | Total PF Lead |
| | | 1-Cycle Auxiliary Values |
| rt.nEU.C | In RT | In Current |
| rt.FrEq | FREQ RT | Frequency |
| | | 1-Sec Phase Values |
| Ar.U1 | V1/12 AVR ¹ | V1/V12 Voltage |
| Ar.U2 | V2/23 AVR ¹ | V2/V23 Voltage |
| Ar.U3 | V3/31 AVR ¹ | V3/V31 Voltage |
| Ar.U12 | V12 AVR | V12 Voltage |
| Ar.U23 | V23 AVR | V23 Voltage |
| Ar.U31 | V31 AVR | V31 Voltage |
| Ar.C1 | I1 AVR | I1 Current |
| Ar.C2 | I2 AVR | I2 Current |
| Ar.C3 | I3 AVR | I3 Current |
| | | 1-Sec Total Values |
| Ar.Ac.P | kW AVR | Total kW |
| Ar.rE.P | kvar AVR | Total kvar |
| Ar.AP.P | kVA AVR | Total kVA |
| Ar.PF | PF AVR | Total PF |
| Ar.PF.LG | PF LAG AVR | Total PF Lag |
| Ar.PF.Ld | PF LEAD AVR | Total PF Lead |
| | | 1-Sec Auxiliary Values |
| rt.nEU.C | In AVR | In Current |
| rt.FrEq | FREQ AVR | Frequency |
| | | Present Demands ^E |
| d.P.i | kW IMP ACC DMD | Accumulated kW import demand |
| d.P.E | kW EXP ACC DMD | Accumulated kW export demand |
| d.q.i | kvar IMP ACC DMD | Accumulated kvar import demand |
| d.q.E | kvar EXP ACC DMD | Accumulated kvar export demand |
| d.S | kVA ACC DMD | Accumulated kVA demand |

¹ In 4LN3, 3LN3 and 3BLN3 wiring modes, the voltages will be line-to-neutral; for any other wiring mode, they will be line-to-line voltages.

Appendix C Setpoint Triggers and Actions

Setpoint Triggers

| Display Code | Designation | Description |
|--------------|---------------------------|---|
| nonE | NONE | None (condition is not active) |
| | | Status Inputs |
| St1.On | STAT INP #1 ON | Status input #1 ON |
| St2.On | STAT INP #2 ON | Status input #2 ON |
| St1.OFF | STAT INP #1 OFF | Status input #1 OFF |
| St2.OFF | STAT INP #2 OFF | Status input #2 OFF |
| | | Relays |
| rL1.On | RELAY #1 ON | Relay #1 ON |
| rL2.On | RELAY #2 ON | Relay #2 ON |
| rL1.OFF | RELAY #1 OFF | Relay #1 OFF |
| rL2.OFF | RELAY #2 OFF | Relay #2 OFF |
| | | Phase Reversal |
| POS.Ph.r | POS PHASE REVERSAL | Positive phase rotation reversal |
| nEG.Ph.r | NEG PHASE REVERSAL | Negative phase rotation reversal |
| | | Voltage Disturbance^{EH} |
| U.diSt | VOLT DIST ² | Voltage disturbance |
| | | Analog Inputs |
| A.In1.Hi | HI AI1 | High analog input #1 |
| A.In2.Hi | HI AI2 | High analog input #2 |
| A.In1.Lo | LO AI1 | Low analog input #1 |
| A.In1.Lo | LO AI2 | Low analog input #2 |
| | | 1-Cycle Phase Values |
| rtHi.C1 | HI I1 RT | High I1 current |
| rtHi.C2 | HI I2 RT | High I2 current |
| rtHi.C3 | HI I3 RT | High I3 current |
| rtLo.C1 | LO I1 RT | Low I1 current |
| rtLo.C2 | LO I2 RT | Low I2 current |
| rtLo.C3 | LO I3 RT | Low I3 current |
| | | 1-Cycle Values on any Phase |
| rtHi. U | HI VOLT RT ¹ | High voltage |
| rtLo. U | LO VOLT RT ¹ | Low voltage |
| rtHi. C | HI AMPS RT | High current |
| rtLo. C | LO AMPS RT | Low current |
| rtthd.U | HI V THD ² | High voltage THD |
| rtthd.C | HI I THD | High current THD |
| rthFc.C | HI K F RT | High K-Factor |
| rttdd.C | HI I TDD | High current TDD |
| | | 1-Cycle Auxiliary Values |
| rtHi.Fr | HI FREQ RT | High frequency |
| rtLo.Fr | LO FREQ RT | Low frequency |
| rtHU.Ub | HI V UNB% RT ¹ | High voltage unbalance |
| rtHC.Ub | HI I UNB% RT | High current unbalance |
| | | 1-Sec Phase Values |
| ArHi.C1 | HI I1 AVR | High I1 current |
| ArHi.C2 | HI I2 AVR | High I2 current |
| ArHi.C3 | HI I3 AVR | High I3 current |
| ArLo.C1 | LO I1 AVR | Low I1 current |
| ArLo.C2 | LO I2 AVR | Low I2 current |
| ArLo.C3 | LO I3 AVR | Low I3 current |
| | | 1-Sec Values on any Phase |
| ArHi. U | HI VOLT AVR ¹ | High voltage |
| ArLo. U | LO VOLT AVR ¹ | Low voltage |
| ArHi. C | HI AMPS AVR | High current |
| ArLo. C | LO AMPS AVR | Low current |
| | | 1-Sec Total Values |
| ArHi.P.i | HI kW IMP AVR | High total kW import |
| ArHi.P.E | HI kW EXP AVR | High total kW export |
| ArHi.q.i | HI kvar IMP AVR | High total kvar import |

| Display Code | Designation | Description |
|--------------|---------------------------|--|
| ArHi.q.E | HI kvar EXP AVR | High total kvar export |
| ArHi.S | HI kVA AVR | High total kVA |
| ArPF.LG | HI PF LAG AVR | Low total PF Lag |
| ArPF.Ld | HI PF LEAD AVR | Low total PF Lead |
| | | 1-Sec Auxiliary Values |
| ArnEU.C | HI In AVR | High neutral current |
| ArHi.Fr | HI FREQ RT | High frequency |
| ArLo.Fr | LO FREQ RT | Low frequency |
| ArHU.Ub | HI V UNB% RT ¹ | High voltage unbalance |
| ArHC.Ub | HI I UNB% RT | High current unbalance |
| | | Present Demands |
| Hi d.U1 | HI V1/12 DMD ¹ | High V1/V12 Volt demand |
| Hi d.U2 | HI V2/23 DMD ¹ | High V2/V23 Volt demand |
| Hi d.U3 | HI V3/31 DMD ¹ | High V3/V31 Volt demand |
| Hi d.C1 | HI I1 DMD | High I1 Ampere demand |
| Hi d.C2 | HI I2 DMD | High I2 Ampere demand |
| Hi d.C3 | HI I3 DMD | High I3 Ampere demand |
| Hi d.P.i | HI kW IMP BD | High block kW import demand |
| Hi d.P.E | HI kW EXP BD | High block kW export demand |
| Hi d.q.i | HI kvar IMP BD | High block kvar import demand |
| Hi d.q.i | HI kvar EXP BD | High block kvar export demand |
| Hi d.S | HI kVA BD | High block kVA demand |
| HiSd.P.i | HI kW IMP SD | High sliding window kW import demand |
| HiSd.P.E | HI kW EXP SD | High sliding window kW export demand |
| HiSd.q.i | HI kvar IMP SD | High sliding window kvar import demand |
| HiSd.q.i | HI kvar EXP SD | High sliding window kvar export demand |
| HiSd.S | HI kVA SD | High sliding window kVA demand |
| HiAd.P.i | HI kW IMP ACC DMD | High accumulated kW import demand |
| HiAd.P.E | HI kW EXP ACC DMD | High accumulated kW export demand |
| HiAd.q.i | HI kvar IMP ACC DMD | High accumulated kvar import demand |
| HiAd.q.i | HI kvar EXP ACC DMD | High accumulated kvar export demand |
| HiAd.S | HI kVA ACC DMD | High accumulated kVA demand |
| HiPd.P.i | HI kW IMP PRD DMD | High predicted kW import demand |
| HiPd.P.E | HI kW EXP PRD DMD | High predicted kW export demand |
| HiPd.q.i | HI kvar IMP PRD DMD | High predicted kvar import demand |
| HiPd.q.i | HI kvar EXP PRD DMD | High predicted kvar export demand |
| HiPd.S | HI kVA PRD DMD | High predicted kVA demand |
| | | Pulse Inputs |
| PLS.In.1 | PULSE INPUT #1 | Pulse input #1 |
| PLS.In.2 | PULSE INPUT #2 | Pulse input #2 |
| | | Internal Events ^E |
| PLS.Ac.i | kWh IMP PULSE | kWh import pulse |
| PLS.Ac.E | kWh EXP PULSE | kWh export pulse |
| PLS.rE.i | kvarh IMP PULSE | kvarh import pulse |
| PLS.rE.E | kvarh EXP PULSE | kvarh export pulse |
| PLS.rE.t | kvarh TOT PULSE | kvarh total pulse |
| PLS.AP.t | kVAh TOT PULSE | kVAh total pulse |
| PLS.P.dn | START DMD INT | Start new demand interval |
| PLS.S.dn | START SD INT | Start new sliding window demand interval |
| PLS.A.dn | START AMP DMD INT | Start new volt/ampere demand interval |
| PLS.trF | START TARIFF INT | Start new tariff interval |
| | | Pulse Counters |
| Cnt.1 | HI COUNTER #1 | High pulse counter #1 |
| Cnt.2 | HI COUNTER #2 | High pulse counter #2 |
| Cnt.3 | HI COUNTER #3 | High pulse counter #3 |
| Cnt.4 | HI COUNTER #4 | High pulse counter #4 |
| | | Timers ^E |
| t-r.1 | TIMER #1 | Timer #1 |
| t-r.2 | TIMER #2 | Timer #2 |
| | | TOU Parameters ^E |
| trF | TOU TARIFF | TOU Tariff |
| PrF | TOU PROFILE | TOU Profile |
| | | Time and Date Parameters ^E |
| U.dAY | DAY OF WEEK | Day of week |
| YEar | YEAR | Year |

| Display Code | Designation | Description |
|--------------|------------------|--|
| Mon | MONTH | Month |
| M.dAY | DAY OF MONTH | Day of month |
| hour | HOURS | Hours |
| Min | MINUTES | Minutes |
| SEc | SECONDS | Seconds |
| Inter. | MINUTE INTERVAL | Minute interval (1,2,3,4,5,10,15,20,30,60 min) |
| | | Event Flags ^{EH} |
| FG1.On | EVENT FLAG 1 ON | Event flag #1 ON |
| ... | ... | ... |
| FG8.OFF | EVENT FLAG 8 OFF | Event flag #8 OFF |
| | | Setpoint Status |
| SP1.On | SP 1 ON | Setpoint #1 ON |
| ... | ... | ... |
| SP16.On | SP 16 ON | Setpoint #16 ON |

¹ In 4LN3, 3LN3 and 3BLN3 wiring modes, the voltages will be line-to-neutral; for any other wiring mode, they will be line-to-line voltages.

² In 4LN3, 4LL3, 3LN3, 3LL3, 3BLN3 and 3BLL3 wiring modes, the voltages will be line-to-neutral; for any other wiring mode, they will be line-to-line.

Setpoint Actions

| Display Code | Designation | Description |
|--------------|----------------------|--|
| none | NONE | None (no action) |
| rEL.1 | OPERATE RELAY #1 | Operate RO1 |
| rEL.2 | OPERATE RELAY #2 | Operate RO2 |
| rEL1.OFF | RELEASE RELAY #1 | Release latched RO1 |
| rEL2.OFF | RELEASE RELAY #2 | Release latched RO2 |
| ELoG | EVENT LOG | Log to Event Log ^E |
| dLoG.1 | DATA LOG #1 | Log to Data Log file #1 ^E |
| dLoG.2 | DATA LOG #2 | Log to Data Log file #2 ^E |
| dLoG.3 | DATA LOG #3 | Log to Data Log file #3 ^E |
| dLoG.4 | DATA LOG #4 | Log to Data Log file #4 ^E |
| dLoG.5 | DATA LOG #5 | Log to Data Log file #5 ^E |
| dLoG.6 | DATA LOG #6 | Log to Data Log file #6 ^E |
| dLoG.7 | DATA LOG #7 | Log to Data Log file #7 ^E |
| dLoG.8 | DATA LOG #8 | Log to Data Log file #8 ^E |
| 32.LoG | WAVEFORM LOG #1 | Log to Waveform Log file #1 ^{EH} |
| 128.LoG | WAVEFORM LOG #2 | Log to Waveform Log file #2 ^{EH} |
| Inc.Cn.1 | INC CNT #1 | Increment counter #1 |
| Inc.Cn.2 | INC CNT #2 | Increment counter #2 |
| Inc.Cn.3 | INC CNT #3 | Increment counter #3 |
| Inc.Cn.4 | INC CNT #4 | Increment counter #4 |
| CLr.Cn.1 | CLR CNT #1 | Clear counter #1 |
| CLr.Cn.2 | CLR CNT #2 | Clear counter #2 |
| CLr.Cn.3 | CLR CNT #3 | Clear counter #3 |
| CLr.Cn.4 | CLR CNT #4 | Clear counter #4 |
| CLr.Cnt | CLR ALL CNT | Clear all counters |
| CLr.Enr | CLR ENERGY | Clear total and phase energy accumulators ^E |
| CLr.dnd | CLR ALL DMD | Clear all maximum demands ^E |
| CLr.P.dn | CLR PWR DMD | Clear power maximum demands ^E |
| CLr.A.dn | CLR VOLT/AMP/THD DMD | Clear volt, ampere and THD maximum demands |
| CLr.tEn | CLR TOU ENG | Clear TOU energy accumulators ^E |
| CLr.tdn | CLR TOU DMD | Clear TOU maximum demands ^E |
| CLr.LHi | CLR MIN/MAX | Clear Min/Max log |
| FLG1.On | SET FLAG #1 | Set event flag #1 ^{EH} |
| FLG2.On | SET FLAG #2 | Set event flag #2 ^{EH} |
| FLG3.On | SET FLAG #3 | Set event flag #3 ^{EH} |
| FLG4.On | SET FLAG #4 | Set event flag #4 ^{EH} |
| FLG1.OFF | CLR FLAG #1 | Clear event flag #1 ^{EH} |
| FLG2.OFF | CLR FLAG #2 | Clear event flag #2 ^{EH} |
| FLG3.OFF | CLR FLAG #3 | Clear event flag #3 ^{EH} |
| FLG4.OFF | CLR FLAG #4 | Clear event flag #4 ^{EH} |

Appendix D Parameters for Data Log and Monitoring

The following table lists parameters measured by the meter that are available for data logging and monitoring through communications. The left column shows data abbreviations used in PAS. Parameter groups are highlighted in bold.

| Designation | Description |
|-----------------------|----------------------------------|
| NONE | None (stub, read as zero) |
| EVENT FLAGS | Event Flags ^{EH} |
| EVENT FLAGS 1:16 | Event Flags #1-#8 |
| DIGITAL INPUTS | Digital Inputs |
| DI1:16 | Digital Inputs Status DI1:DI2 |
| RELAYS | Relays |
| RO1:16 | Relay Status RO1:RO2 |
| COUNTERS | Pulse Counters |
| COUNTER 1 | Counter #1 |
| COUNTER 2 | Counter #2 |
| COUNTER 3 | Counter #3 |
| COUNTER 4 | Counter #4 |
| RT PHASE | 1-Cycle Phase Values |
| V1 | V1/V12 Voltage ¹ |
| V2 | V2/V23 Voltage ¹ |
| V3 | V3/V31 Voltage ¹ |
| I1 | I1 Current |
| I2 | I2 Current |
| I3 | I3 Current |
| kW L1 | kW L1 |
| kW L2 | kW L2 |
| kW L3 | kW L3 |
| kvar L1 | kvar L1 |
| kvar L2 | kvar L2 |
| kvar L3 | kvar L3 |
| kVA L1 | kVA L1 |
| kVA L2 | kVA L2 |
| kVA L3 | kVA L3 |
| PF L1 | Power factor L1 |
| PF L2 | Power factor L2 |
| PF L3 | Power factor L3 |
| V1 THD | V1/V12 Voltage THD ² |
| V2 THD | V2/V23 Voltage THD ² |
| V3 THD | V3/V31 Voltage THD ² |
| I1 THD | I1 Current THD |
| I2 THD | I2 Current THD |
| I3 THD | I3 Current THD |
| I1 KF | I1 K-Factor |
| I2 KF | I2 K-Factor |
| I3 KF | I3 K-Factor |
| I1 TDD | I1 Current TDD |
| I2 TDD | I2 Current TDD |
| I3 TDD | I3 Current TDD |
| V12 | V12 Voltage |
| V23 | V23 Voltage |
| V31 | V31 Voltage |
| RT TOTAL | 1-Cycle Total Values |
| kW | Total kW |
| kvar | Total kvar |
| kVA | Total kVA |
| PF | Total PF |
| PF LAG | Total PF lag |

| Designation | Description |
|------------------|--|
| PF LEAD | Total PF lead |
| KW IMP | Total kW import |
| KW EXP | Total kW export |
| kvar IMP | Total kvar import |
| kvar EXP | Total kvar export |
| V AVG | 3-phase average L-N/L-L voltage |
| V LL AVG | 3-phase average L-L voltage |
| I AVG | 3-phase average current |
| RT AUX | 1-Cycle Auxiliary Values |
| In | In (neutral) Current |
| FREQ | Frequency |
| V UNB% | Voltage unbalance |
| I UNB% | Current unbalance |
| AVR PHASE | 1-Second Phase Values |
| V1 | V1/V12 Voltage |
| V2 | V2/V23 Voltage |
| V3 | V3/V31 Voltage |
| I1 | I1 Current |
| I2 | I2 Current |
| I3 | I3 Current |
| kW L1 | kW L1 |
| kW L2 | kW L2 |
| kW L3 | kW L3 |
| kvar L1 | kvar L1 |
| kvar L2 | kvar L2 |
| kvar L3 | kvar L3 |
| kVA L1 | kVA L1 |
| kVA L2 | kVA L2 |
| kVA L3 | kVA L3 |
| PF L1 | Power factor L1 |
| PF L2 | Power factor L2 |
| PF L3 | Power factor L3 |
| V1 THD | V1/V12 Voltage THD |
| V2 THD | V2/V23 Voltage THD |
| V3 THD | V3/V31 Voltage THD |
| I1 THD | I1 Current THD |
| I2 THD | I2 Current THD |
| I3 THD | I3 Current THD |
| I1 KF | I1 K-Factor |
| I2 KF | I2 K-Factor |
| I3 KF | I3 K-Factor |
| I1 TDD | I1 Current TDD |
| I2 TDD | I2 Current TDD |
| I3 TDD | I3 Current TDD |
| V12 | V12 Voltage |
| V23 | V23 Voltage |
| V31 | V31 Voltage |
| AVR TOTAL | 1-Second Total Values |
| kW | Total kW |
| kvar | Total kvar |
| kVA | Total kVA |
| PF | Total PF |
| PF LAG | Total PF lag |
| PF LEAD | Total PF lead |
| KW IMP | Total kW import |
| KW EXP | Total kW export |
| kvar IMP | Total kvar import |
| kvar EXP | Total kvar export |
| V AVG | 3-phase average L-N/L-L voltage ¹ |
| V LL AVG | 3-phase average L-L voltage |
| I AVG | 3-phase average current |
| AVR AUX | 1-Second Auxiliary Values |
| In | In (neutral) Current |
| FREQ | Frequency |
| V UNB% | Voltage unbalance |
| I UNB% | Current unbalance |

| Designation | Description |
|---------------------|---|
| PHASORS | Phasors |
| V1 Mag | V1/V12 Voltage magnitude ¹ |
| V2 Mag | V2/V23 Voltage magnitude ¹ |
| V3 Mag | V3/V31 Voltage magnitude ¹ |
| I1 Mag | I1 Current magnitude |
| I2 Mag | I2 Current magnitude |
| I3 Mag | I3 Current magnitude |
| V1 Ang | V1/V12 Voltage angle ¹ |
| V2 Ang | V2/V23 Voltage angle ¹ |
| V3 Ang | V3/V31 Voltage angle ¹ |
| I1 Ang | I1 Current angle |
| I2 Ang | I2 Current angle |
| I3 Ang | I3 Current angle |
| DEMANDS | Present Demands (Power Demands ^E) |
| V1 DMD | V1/V12 Volt demand ¹ |
| V2 DMD | V2/V23 Volt demand ¹ |
| V3 DMD | V3/V31 Volt demand ¹ |
| I1 DMD | I1 Ampere demand |
| I2 DMD | I2 Ampere demand |
| I3 DMD | I3 Ampere demand |
| kW IMP BD | kW import block demand |
| kvar IMP BD | kvar import block demand |
| kVA BD | kVA block demand |
| kW IMP SD | kW import sliding window demand |
| kvar IMP SD | kvar import sliding window demand |
| kVA SD | kVA sliding window demand |
| kW IMP ACC DMD | kW import accumulated demand |
| kvar IMP ACC DMD | kvar import accumulated demand |
| kVA ACC DMD | kVA accumulated demand |
| kW IMP PRD DMD | kW import predicted sliding window demand |
| kvar IMP PRD DMD | kvar import predicted sliding window demand |
| kVA PRD DMD | kVA predicted sliding window demand |
| PF IMP@kVA MXDMD | PF (import) at Maximum kVA sliding window demand |
| kW EXP BD | kW export block demand |
| kvar EXP BD | kvar export block demand |
| kW EXP SD | kW export sliding window demand |
| kvar EXP SD | kvar export sliding window demand |
| kW EXP ACC DMD | kW export accumulated demand |
| kvar EXP ACC DMD | kvar export accumulated demand |
| kW EXP PRD DMD | kW export predicted sliding window demand |
| kvar EXP PRD DMD | kvar export predicted sliding window demand |
| HRM DMD | Present Harmonic Demands |
| V1 THD DMD | V1/V12 THD demand ² |
| V2 THD DMD | V2/V23 THD demand ² |
| V3 THD DMD | V3/V31 THD demand ² |
| I1 THD DMD | I1 THD demand |
| I2 THD DMD | I2 THD demand |
| I3 THD DMD | I3 THD demand |
| I1 TDD DMD | I1 TDD demand |
| I2 TDD DMD | I2 TDD demand |
| I3 TDD DMD | I3 TDD demand |
| SUMM ACC DMD | Summary (TOU Total) Accumulated Demands ^E |
| SUM REG1 ACC DMD | Summary register #1 demand |
| SUM REG2 ACC DMD | Summary register #2 demand |
| ... | ... |
| SUM REG8 ACC DMD | Summary register #8 demand |
| SUMM BLK DMD | Summary (TOU Total) Block Demands ^E |
| SUM REG1 BLK DMD | Summary register #1 demand |
| SUM REG2 BLK DMD | Summary register #2 demand |
| ... | ... |
| SUM REG8 BLK DMD | Summary register #8 demand |
| SUMM SW DMD | Summary (TOU Total) Sliding Demands ^E |
| SUM REG1 SW DMD | Summary register #1 demand |

| Designation | Description |
|---------------------|--|
| SUM REG2 SW DMD | Summary register #2 demand |
| ... | ... |
| SUM REG8 SW DMD | Summary register #8 demand |
| ENERGY | Total Energy ^E |
| kWh IMPORT | kWh import |
| kWh EXPORT | kWh export |
| kvarh IMPORT | kvarh import |
| kvarh EXPORT | kvarh export |
| kVAh TOTAL | kVAh total |
| kWh HRM IMP | Harmonic kWh import ^{EH} |
| kWh HRM EXP | Harmonic kWh export ^{EH} |
| kVAh HRM TOT | Harmonic kVAh total ^{EH} |
| SUMMARY REGS | Summary (TOU Total) Energy Registers ^E |
| SUM REG1 | Summary energy register #1 |
| SUM REG2 | Summary energy register #2 |
| ... | ... |
| SUM REG8 | Summary energy register #8 |
| PHASE ENERGY | Phase Energy ^E |
| kWh IMP L1 | kWh import L1 |
| kWh IMP L2 | kWh import L2 |
| kWh IMP L3 | kWh import L3 |
| kvarh IMP L1 | kvarh import L1 |
| kvarh IMP L2 | kvarh import L2 |
| kvarh IMP L3 | kvarh import L3 |
| kVAh L1 | kVAh total L1 |
| kVAh L2 | kVAh total L2 |
| kVAh L3 | kVAh total L3 |
| %HD V1 | V1/V12 Harmonic Distortions ^{EH 2} |
| V1 %HD01 | H01 Harmonic distortion |
| V1 %HD02 | H02 Harmonic distortion |
| ... | ... |
| V1 %HD40 | H40 Harmonic distortion |
| %HD V2 | V2/V23 Harmonic Distortions ^{EH 2} |
| V2 %HD01 | H01 Harmonic distortion |
| V2 %HD02 | H02 Harmonic distortion |
| ... | ... |
| V2 %HD40 | H40 Harmonic distortion |
| %HD V3 | V3/V31 Harmonic Distortions ^{EH 2} |
| V3 %HD01 | H01 Harmonic distortion |
| V3 %HD02 | H02 Harmonic distortion |
| ... | ... |
| V3 %HD40 | H40 Harmonic distortion |
| %HD I1 | I1 Harmonic Distortions ^{EH} |
| I1 %HD01 | H01 Harmonic distortion |
| I1 %HD02 | H02 Harmonic distortion |
| ... | ... |
| I1 %HD40 | H40 Harmonic distortion |
| %HD I2 | I2 Harmonic Distortions ^{EH} |
| I2 %HD01 | H01 Harmonic distortion |
| I2 %HD02 | H02 Harmonic distortion |
| ... | ... |
| I2 %HD40 | H40 Harmonic distortion |
| %HD I3 | I3 Harmonic Distortions ^{EH} |
| I3 %HD01 | H01 Harmonic distortion |
| I3 %HD02 | H02 Harmonic distortion |
| ... | ... |
| I3 %HD40 | H40 Harmonic distortion |
| ANG V1 | V1/V12 Harmonic Angles ^{EH 2} |
| V1 H01 ANG | H01 Harmonic angle |
| V1 H02 ANG | H02 Harmonic angle |
| ... | ... |
| V1 H40 ANG | H40 Harmonic angle |

| Designation | Description |
|--------------------|--|
| ANG V2 | V2/V23 Harmonic Angles ^{EH 2} |
| V2 H01 ANG | H01 Harmonic angle |
| V2 H02 ANG | H02 Harmonic angle |
| ... | ... |
| V2 H40 ANG | H40 Harmonic angle |
| ANG V3 | V3/V31 Harmonic Angles ^{EH 2} |
| V3 H01 ANG | H01 Harmonic angle |
| V3 H02 ANG | H02 Harmonic angle |
| ... | ... |
| V3 H40 ANG | H40 Harmonic angle |
| ANG I1 | I1 Harmonic Angles ^{EH} |
| I1 H01 ANG | H01 Harmonic angle |
| I1 H02 ANG | H02 Harmonic angle |
| ... | ... |
| I1 H40 ANG | H40 Harmonic angle |
| ANG I2 | I2 Harmonic Angles ^{EH} |
| I2 H01 ANG | H01 Harmonic angle |
| I2 H02 ANG | H02 Harmonic angle |
| ... | ... |
| I2 H40 ANG | H40 Harmonic angle |
| ANG I3 | I3 Harmonic Angles ^{EH} |
| I3 H01 ANG | H01 Harmonic angle |
| I3 H02 ANG | H02 Harmonic angle |
| ... | ... |
| I3 H40 ANG | H40 Harmonic angle |
| H1 PHASE | Fundamental (H01) Phase Values |
| V1 H01 | V1/V12 Voltage ² |
| V2 H01 | V2/V23 Voltage ² |
| V3 H01 | V3/V31 Voltage ² |
| I1 H01 | I1 Current |
| I2 H01 | I2 Current |
| I3 H01 | I3 Current |
| kW L1 H01 | kW L1 |
| kW L2 H01 | kW L2 |
| kW L3 H01 | kW L3 |
| kvar L1 H01 | kvar L1 |
| kvar L2 H01 | kvar L2 |
| kvar L3 H01 | kvar L3 |
| kVA L1 H01 | kVA L1 |
| kVA L2 H01 | kVA L2 |
| kVA L3 H01 | kVA L3 |
| PF L1 H01 | Power factor L1 |
| PF L2 H01 | Power factor L2 |
| PF L3 H01 | Power factor L3 |
| HRM TOT POW | Fundamental and Harmonic Total Power Values |
| kW HRM | Total fundamental kW |
| kvar HRM | Total fundamental kvar |
| kVA HRM | Total fundamental kVA |
| PF HRM | Total fundamental PF |
| kW HRM | Total harmonic kW ^{EH} |
| kVA HRM | Total harmonic kVA ^{EH} |
| MIN PHASE | Minimum 1-Cycle Phase Values |
| V1 MIN | V1/V12 Voltage ¹ |
| V2 MIN | V2/V23 Voltage ¹ |
| V3 MIN | V3/V31 Voltage ¹ |
| I1 MIN | I1 Current |
| I2 MIN | I2 Current |
| I3 MIN | I3 Current |
| V1 THD MIN | V1/V12 Voltage THD ² |
| V2 THD MIN | V2/V23 Voltage THD ² |
| V3 THD MIN | V3/V31 Voltage THD ² |
| I1 THD MIN | I1 Current THD |

| Designation | Description |
|--------------------|---|
| I2 THD MIN | I2 Current THD |
| I3 THD MIN | I3 Current THD |
| I1 KF MIN | I1 K-Factor |
| I2 KF MIN | I2 K-Factor |
| I3 KF MIN | I3 K-Factor |
| I1 TDD MIN | I1 Current TDD |
| I2 TDD MIN | I2 Current TDD |
| I3 TDD MIN | I3 Current TDD |
| MIN TOTAL | Minimum 1-Cycle Total Values |
| kW MIN | Total kW |
| kvar MIN | Total kvar |
| kVA MIN | Total kVA |
| PF MIN | Total PF |
| MIN AUX | Minimum 1-Cycle Auxiliary Values |
| In MIN | In Current |
| FREQ MIN | Frequency |
| MAX PHASE | Maximum 1-Cycle Phase Values |
| V1 MAX | V1/V12 Voltage ¹ |
| V2 MAX | V2/V23 Voltage ¹ |
| V3 MAX | V3/V31 Voltage ¹ |
| I1 MAX | I1 Current |
| I2 MAX | I2 Current |
| I3 MAX | I3 Current |
| V1 THD MAX | V1/V12 Voltage THD ² |
| V2 THD MAX | V2/V23 Voltage THD ² |
| V3 THD MAX | V3/V31 Voltage THD ² |
| I1 THD MAX | I1 Current THD |
| I2 THD MAX | I2 Current THD |
| I3 THD MAX | I3 Current THD |
| I1 KF MAX | I1 K-Factor |
| I2 KF MAX | I2 K-Factor |
| I3 KF MAX | I3 K-Factor |
| I1 TDD MAX | I1 Current TDD |
| I2 TDD MAX | I2 Current TDD |
| I3 TDD MAX | I3 Current TDD |
| MAX TOTAL | Maximum 1-Cycle Total Values |
| kW MAX | Total kW |
| kvar MAX | Total kvar |
| kVA MAX | Total kVA |
| PF MAX | Total PF |
| MAX AUX | Maximum 1-Cycle Auxiliary Values |
| In MAX | In Current |
| FREQ MAX | Frequency |
| MAX DMD | Maximum Demands (Power Demands ^E) |
| V1 DMD MAX | V1/V12 Maximum volt demand ¹ |
| V2 DMD MAX | V2/V23 Maximum volt demand ¹ |
| V3 DMD MAX | V3/V31 Maximum volt demand ¹ |
| I1 DMD MAX | I1 Maximum ampere demand |
| I2 DMD MAX | I2 Maximum ampere demand |
| I3 DMD MAX | I3 Maximum ampere demand |
| kW IMP SD MAX | Maximum kW import sliding window demand |
| kW EXP SD MAX | Maximum kvar import sliding window demand |
| kvar IMP SD MAX | Maximum kW export sliding window demand |
| kvar EXP SD MAX | Maximum kvar export sliding window demand |
| kVA SD MAX | Maximum kVA sliding window demand |
| MAX HRM DMD | Maximum Harmonic Demands |
| V1 THD DMD MAX | V1/V12 THD demand ² |
| V2 THD DMD MAX | V2/V23 THD demand ² |
| V3 THD DMD MAX | V3/V31 THD demand ² |
| I1 THD DMD MAX | I1 THD demand |
| I2 THD DMD MAX | I2 THD demand |
| I3 THD DMD MAX | I3 THD demand |
| I1 TDD DMD MAX | I1 TDD demand |
| I2 TDD DMD MAX | I2 TDD demand |

| Designation | Description |
|-------------------------|--|
| I3 TDD DMD MAX | I3 TDD demand |
| MAX SUMMARY DMD | Maximum Summary (TOU Total) Demands^E |
| SUM REG1 DMD MAX | Summary register #1 maximum demand |
| SUM REG2 DMD MAX | Summary register #2 maximum demand |
| ... | ... |
| SUM REG8 DMD MAX | Summary register #8 maximum demand |
| ANALOG INPUTS | Scaled Analog Inputs (Engineering Units) |
| A11 | Analog input A11 |
| A12 | Analog input A12 |
| AI RAW | Raw Analog Inputs (A/D Units) |
| A11 RAW | Analog input A11 |
| A12 RAW | Analog input A12 |
| AO RAW | Raw Analog Outputs (A/D Units) |
| AO1 | Analog output A11 |
| AO2 | Analog output A12 |
| TOU PRMS | TOU Parameters^E |
| ACTIVE TARIFF | Active TOU tariff |
| ACTIVE PROFILE | Active TOU profile |
| TOU REG1 | TOU Energy Register #1^E |
| TOU REG1 TRF1 | Tariff #1 register |
| TOU REG1 TRF2 | Tariff #2 register |
| ... | ... |
| TOU REG1 TRF8 | Tariff #8 register |
| TOU REG2 | TOU Energy Register #2^E |
| TOU REG2 TRF1 | Tariff #1 register |
| TOU REG2 TRF2 | Tariff #2 register |
| ... | ... |
| TOU REG2 TRF8 | Tariff #8 register |
| TOU REG3 | TOU Energy Register #3^E |
| TOU REG3 TRF1 | Tariff #1 register |
| TOU REG3 TRF2 | Tariff #2 register |
| ... | ... |
| TOU REG3 TRF8 | Tariff #8 register |
| TOU REG4 | TOU Energy Register #4^E |
| TOU REG4 TRF1 | Tariff #1 register |
| TOU REG4 TRF2 | Tariff #2 register |
| ... | ... |
| TOU REG4 TRF8 | Tariff #8 register |
| TOU REG5 | TOU Energy Register #5^E |
| TOU REG5 TRF1 | Tariff #1 register |
| TOU REG5 TRF2 | Tariff #2 register |
| ... | ... |
| TOU REG5 TRF8 | Tariff #8 register |
| TOU REG6 | TOU Energy Register #6^E |
| TOU REG6 TRF1 | Tariff #1 register |
| TOU REG6 TRF2 | Tariff #2 register |
| ... | ... |
| TOU REG6 TRF8 | Tariff #8 register |
| TOU REG7 | TOU Energy Register #7^E |
| TOU REG7 TRF1 | Tariff #1 register |
| TOU REG7 TRF2 | Tariff #2 register |
| ... | ... |
| TOU REG7 TRF8 | Tariff #8 register |
| TOU REG8 | TOU Energy Register #8^E |
| TOU REG8 TRF1 | Tariff #1 register |
| TOU REG8 TRF2 | Tariff #2 register |
| ... | ... |
| TOU REG8 TRF8 | Tariff #8 register |
| TOU MAX DMD REG1 | TOU Maximum Demand Register #1^E |
| DMD1 TRF1 MAX | Tariff #1 register |
| DMD1 TRF2 MAX | Tariff #2 register |
| ... | ... |

| Designation | Description |
|-------------------------|--|
| DMD1 TRF8 MAX | Tariff #8 register |
| TOU MAX DMD REG2 | TOU Maximum Demand Register #2 ^E |
| DMD2 TRF1 MAX | Tariff #1 register |
| DMD2 TRF2 MAX | Tariff #2 register |
| ... | ... |
| DMD2 TRF8 MAX | Tariff #8 register |
| TOU MAX DMD REG3 | TOU Maximum Demand Register #3 ^E |
| DMD3 TRF1 MAX | Tariff #1 register |
| DMD3 TRF2 MAX | Tariff #2 register |
| ... | ... |
| DMD3 TRF8 MAX | Tariff #8 register |
| TOU MAX DMD REG4 | TOU Maximum Demand Register #4 ^E |
| DMD4 TRF1 MAX | Tariff #1 register |
| DMD4 TRF2 MAX | Tariff #2 register |
| ... | ... |
| DMD4 TRF8 MAX | Tariff #8 register |
| TOU MAX DMD REG5 | TOU Maximum Demand Register #5 ^E |
| DMD5 TRF1 MAX | Tariff #1 register |
| DMD5 TRF2 MAX | Tariff #2 register |
| ... | ... |
| DMD5 TRF8 MAX | Tariff #8 register |
| TOU MAX DMD REG6 | TOU Maximum Demand Register #6 ^E |
| DMD6 TRF1 MAX | Tariff #1 register |
| DMD6 TRF2 MAX | Tariff #2 register |
| ... | ... |
| DMD6 TRF8 MAX | Tariff #8 register |
| TOU MAX DMD REG7 | TOU Maximum Demand Register #7 ^E |
| DMD7 TRF1 MAX | Tariff #1 register |
| DMD7 TRF2 MAX | Tariff #2 register |
| ... | ... |
| DMD7 TRF8 MAX | Tariff #8 register |
| TOU MAX DMD REG8 | TOU Maximum Demand Register #8 ^E |
| DMD8 TRF1 MAX | Tariff #1 register |
| DMD8 TRF2 MAX | Tariff #2 register |
| ... | ... |
| DMD8 TRF8 MAX | Tariff #8 register |

¹ In 4LN3, 3LN3 and 3BLN3 wiring modes, the voltages will be line-to-neutral; for any other wiring mode, they will be line-to-line voltages.

² In 4LN3, 4LL3, 3LN3, 3LL3, 3BLN3 and 3BLL3 wiring modes, the voltages will be line-to-neutral; for any other wiring mode, they will be line-to-line.

Appendix E Data Scales

The maximum values for volts, amps and power in the PM172 setup and in communications are limited by the voltage and current scale settings. See [Device Options](#) in Chapter 4 on how to change the voltage scale in your meter.

The following table defines the meter data scales.

| Scale | Conditions | Range |
|------------------------------------|---|--|
| Maximum voltage (V max) | All configurations | Voltage scale \times PT Ratio, V ¹ |
| Maximum current (I max) | All configurations | Current scale \times CT Ratio, A ^{2, 3} |
| Maximum Power (P max) ⁴ | Wiring 4LN3, 3LN3, 3BLN3 | V max \times I max \times 3, W |
| | Wiring 4LL3, 3LL3, 3BLL3, 3OP2, 3OP3, 3DIR2 | V max \times I max \times 2, W |
| Maximum frequency | 25, 50 or 60 Hz | 100 Hz |
| | 400Hz | 500 Hz |

¹ The default voltage scale is 144V. The recommended voltage scale is $120V + 20\% = 144V$ for using with external PT's, and $690V + 20\% = 828V$ for a direct connection to power line.

² CT Ratio = CT primary current/CT secondary current

³ The default current scale is $2 \times$ CT secondary (2.0A with 1A secondaries and 10.0A with 5A secondaries).

⁴ Maximum power is rounded to whole kilowatts. With PT=1.0, it is limited to 9,999,000 W.

Appendix F Device Diagnostic Codes

| Diagnostic Code | Description | Reason |
|-----------------|---------------------------|---|
| 2 | Memory/Data fault | Hardware failure |
| 3 | Hardware watchdog reset | Hardware failure |
| 5 | CPU exception | Hardware failure |
| 6 | Run-time software error | Hardware failure |
| 7 | Software watchdog timeout | Hardware failure |
| 8 | Power Down/Up | Normal power-up sequence |
| 9 | Warm restart | External restart via communications or by firmware upgrade |
| 10 | Configuration reset | Corrupted setup data has been replaced with the default configuration |
| 11 | RTC fault | The clock time has been lost |
| 13 | Low battery | Battery replacement is required. With auto-reset. |
| 15 | EEPROM fault | Hardware failure |

See [Device Diagnostics](#) in Chapter 4 for more information on the PM172 built-in diagnostics.